

NEWS 2022

DAKAR  
OSLO  
TOLEDO

dvo

**dvo.**

# Index

Dakar P. 02



Oslo P. 22



Toledo P. 54



# Dakar

DV914

Linea direzionale dal disegno aereo che fa della sua leggerezza l'immagine caratterizzante. Le calde finiture dei suoi elementi, assicurano a questa serie un tocco di classe che la contraddistingue. Le gambe coniche in versione bianco, cromo e antracite si abbinano alle diverse finiture dei piani di lavoro.

*Executive line with an ethereal design that makes of its lightness the characterizing image. The warm finishes of its elements ensure this series a touch of class that distinguishes it. The conical legs in white, chrome and anthracite are combined with various finishes of worktops.*











Nella collezione Dakar sono previste delle soluzioni per la gestione dei cavi che consentono di organizzare in modo efficiente il proprio spazio di lavoro.



*The Dakar collection includes cable and wire management solutions that create an efficiently organised workspace.*









I tavoli Dakar possono essere abbinati ai mobili di servizio direzionali o alle madie della serie Milo. La collezione può essere inoltre corredata da svariati componenti e accessori per personalizzare al meglio l'ufficio direzionale.

*The tables of the Dakar series can be combined with the executives service units or to the sideboards of the Milo series. The collection can also be equipped with various components and accessories to customize the executive office.*

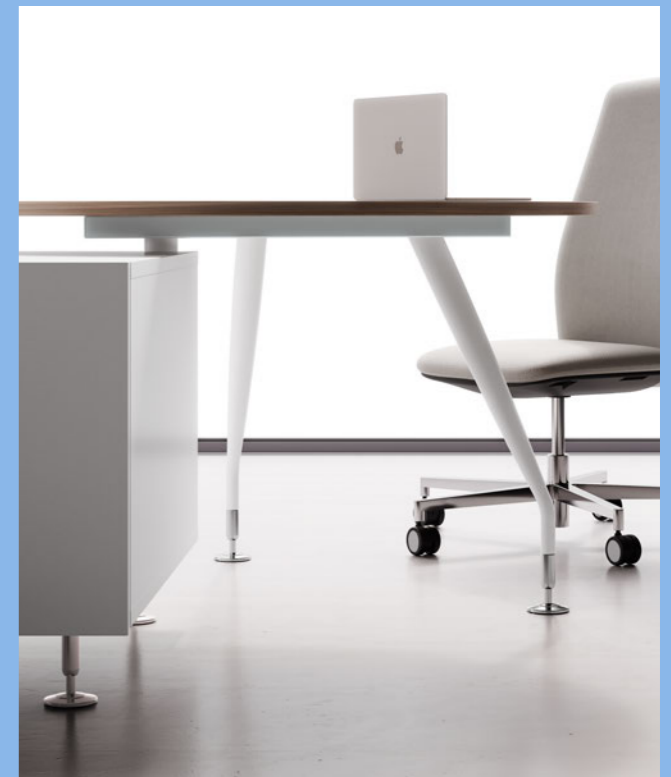

Tavoli / Tables

Piani di lavoro sp. 2.5 cm, in melaminico / Worktops 2.5 cm thick, in melamine

Piani di lavoro in cuoio con cuciture, sp. 2.7 cm / Worktop in leather with stitches, 2.7 cm thick



Strutture metalliche / Metal structures

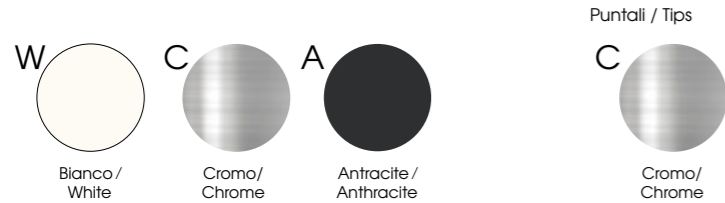

Mobili di servizio / Service units

Scocca, ripiani sp. 2.5 cm e ante sp. 1.8 cm, in melaminico (C) o laminato (\*\*\*) / Body, shelves 2.5 cm and doors 1.8 cm thick, in melamine (C) or laminate (\*\*\*)



Note

Prodotti non in pronta consegna. Per la disponibilità contattare l'ufficio commerciale. / Items not in prompt delivery. Please contact the commercial department to check availability. Per tutte le altre finiture consultare i relativi capitoli all'interno del listino prezzi. / For all other finishes, please refer to the relevant chapters in the price list.

Dati tecnici / Technical data

Dakar DV914

Tavoli scrivania / Desk tables

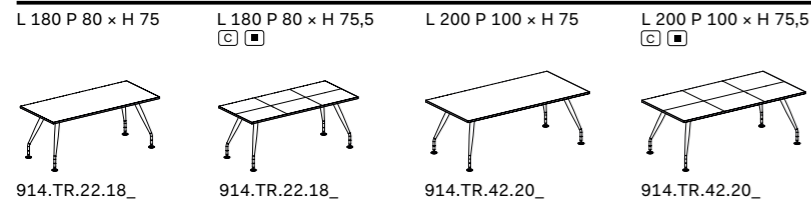

Allunghi per tavoli scrivania / Extension tables for desks

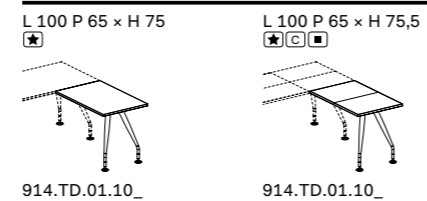

Nota: I tavoli in allungo sono integrabili solo ai tavoli scrivania P= 80 L=180 cm e P= 100 L=200 cm. Per gli altri tavoli è necessario l'utilizzo di viti autofilettanti. / The extension tables can be integrated only on the desk tables P= 80 L= 180 cm and P= 100 L= 200 cm. For the other tables it is necessary to use self-tapping screws.

Tavoli riunione / Meeting tables

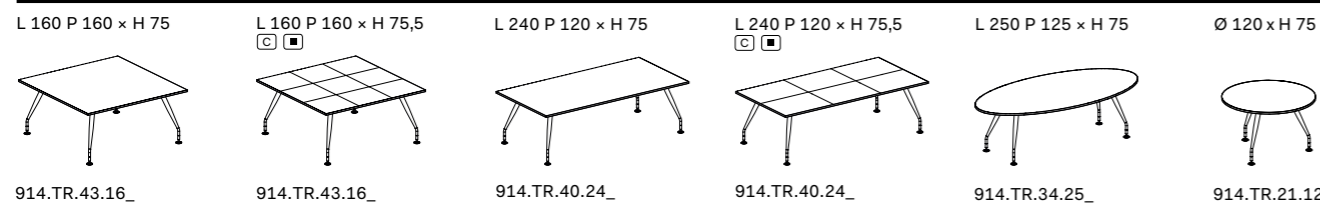

Note

Le finiture in cuoio non sono in pronta consegna. Per la disponibilità contattare l'ufficio commerciale. / Leather finishes are not in prompt delivery. Please contact the commercial department to check availability;

Le dimensioni sono espresse in cm - consultare il listino prezzi per le caratteristiche tecniche, i codici degli articoli e delle finiture. / Dimensions are stated in cm - for technical characteristics, article code numbers and finishing see price list;

Prodotti non in pronta consegna. Per la disponibilità contattare l'ufficio commerciale. / Items not in prompt delivery. Please contact the commercial department to check availability;

Cuoio / Leather;

Tavoli per integrazione con mobili di servizio / Desks for integration with service units

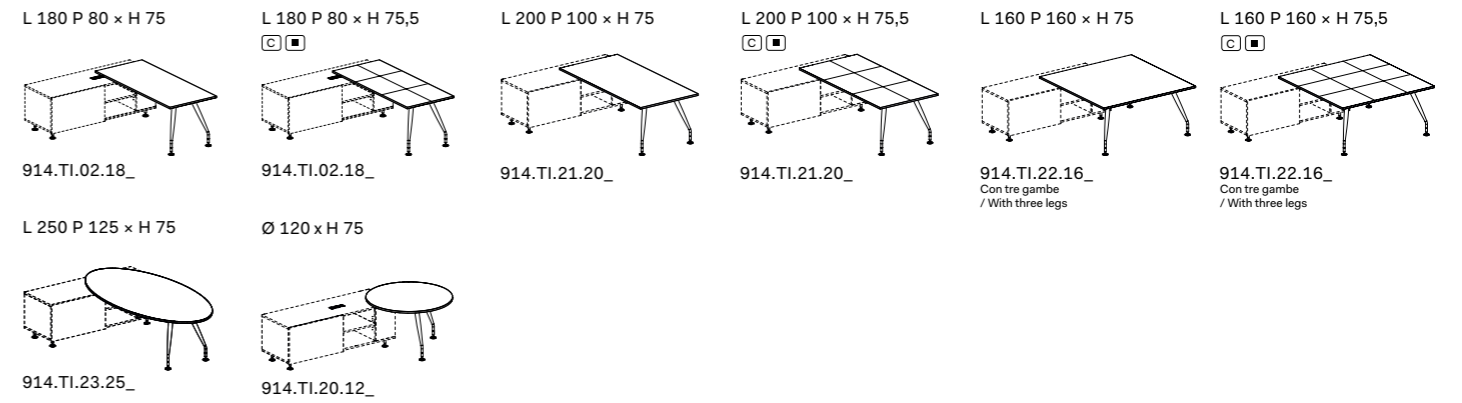

Mobili di servizio e cassetteria interna / Service units and internal pedestals

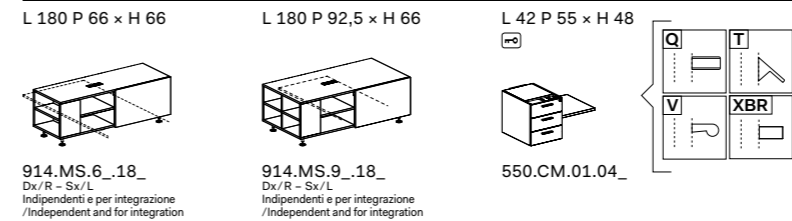

Note: La finitura nero opaco non è in pronta consegna, per la disponibilità contattare l'ufficio commerciale. / Matt black finishes is not in prompt delivery. Please contact the commercial department to check availability.

Esempi posizionamento tavoli con mobili di servizio / Examples of tables positioning with service units

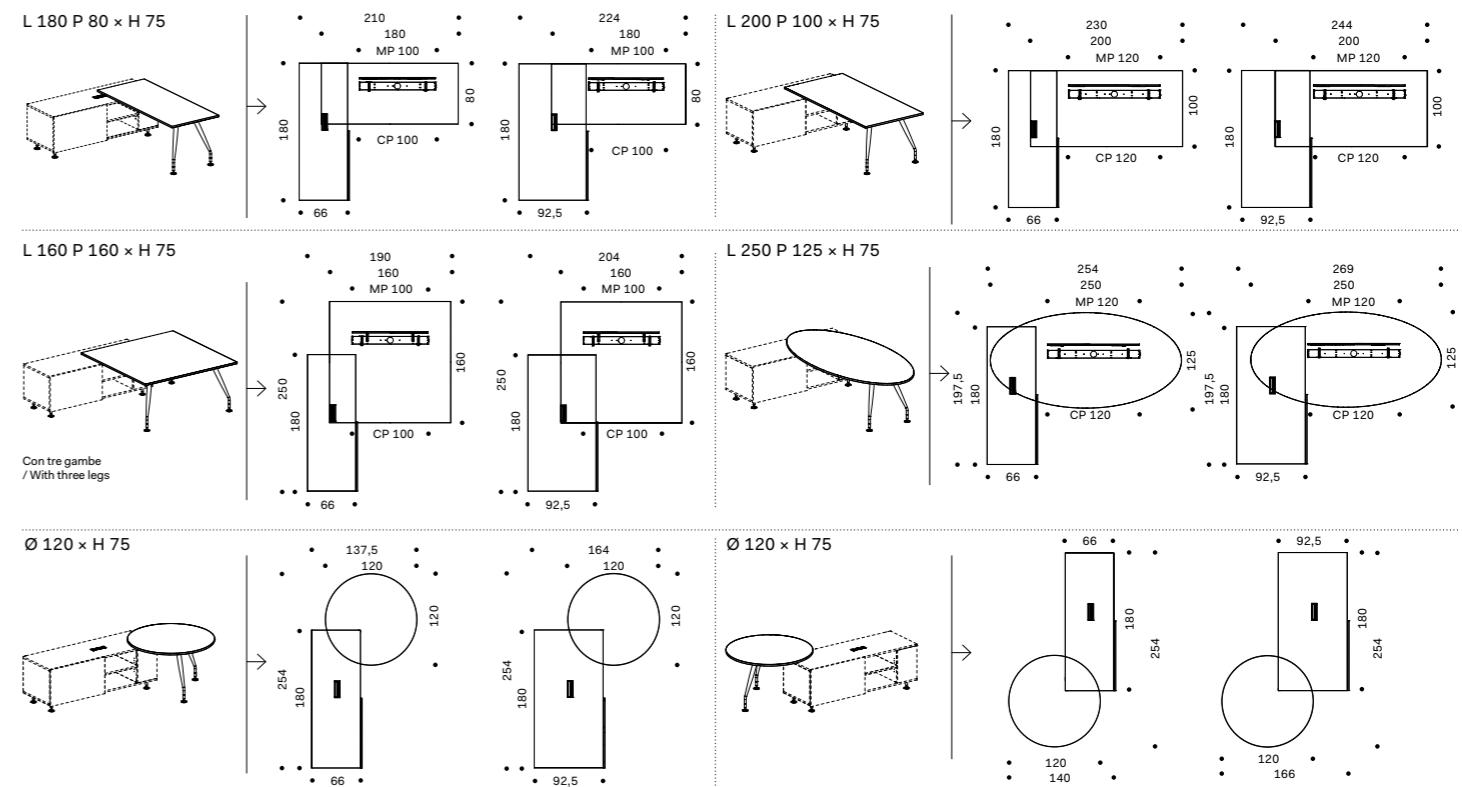

Position 1: Integrato verso lato operatore / Operator side integration

Position 2: Integrato verso lato visitatore / Visitor side integration

Note

Le finiture in cuoio non sono in pronta consegna. Per la disponibilità contattare l'ufficio commerciale. / Leather finishes are not in prompt delivery. Please contact the commercial department to check availability;

I tavoli possono essere montati sui mobili di servizio P 66 e P 92,5 cm (destri o sinistri). Per ogni soluzione compositiva è disponibile a listino la dimensione del corrispondente modesty panel (vedi relativa quota indicata con MP) e del corrispondente canale passacavi (vedi relativa quota indicata con CP). / The desks can be fixed on the service units depth 66 and depth 92,5 cm (right or left hand). To order the modesty panel please check the dimensions marked with MP and the dimensions marked with CP for the relevant cables channel;

Prodotti non in pronta consegna. Per la disponibilità contattare l'ufficio commerciale. / Items not in prompt delivery. Please contact the commercial department to check availability;

Cuoio / Leather;

Con serratura / With lock;

Tavoli per integrazione su moduli base Milo\_DV504 / Desks for integration on modules Milo\_DV504 series

L 180 P 80 x H 75 	L 180 P 80 x H 75,5 	L 200 P 100 x H 75 	L 200 P 100 x H 75,5 	L 160 P 160 x H 75 	L 160 P 160 x H 75,5 
914.TI.02.18_	914.TI.02.18_	914.TI.21.20_	914.TI.21.20_	914.TI.22.16_ Con tre gambe / With three legs	914.TI.22.16_ Con tre gambe / With three legs
L 160 P 160 x H 75 	L 160 P 160 x H 75,5 	L 250 P 125 x H 75 	Ø 120 x H 75 		
914.TI.23.16_ Con due gambe / With two legs	914.TI.23.16_ Con due gambe / With two legs	914.TI.23.25_	914.TI.20.12_		

Esempi posizionamento tavoli su moduli base Milo\_DV504/Examples of tables positioning on modules Milo\_DV504 series

L 180 P 80 x H 75 	L 200 P 100 x H 75 	L 160 P 160 x H 75 
L 160 P 160 x H 75 	L 250 P 125 x H 75 	Ø 120 x H 75 
L 200 P 100 x H 75 		

Note: Il tavolo Ø 120 può essere abbinato solamente all'ultimo modulo di una composizione Milo-DV504. / The Ø 120 table can only be combined with the last module of a Milo-DV504 composition.  
 Note: Per il posizionamento dei tavoli Dakar\_DV914 sui moduli Milo\_DV504 consultare il manuale tecnico o l'ufficio commerciale. / To position the Dakar\_DV914 tables on the Milo\_DV504 modules, please consult the technical manual or contact the commercial department.

Cassettiere/Pedestals

L 42 P 57 x H 55,5 	L 32,2 P 54,2 x H 55,6 	L 42,2 P 54,2 x H 55,6 
550.CS.10.04 Melaminico/Melamine	550.CS.20.04 Melaminico/Melamine	550.CS.1M.03 Metalliche "slim" /Metallic "slim"
550.CS.1M.04 Metalliche/Metallic Vaschetta portacancelleria inclusa / Stationery tray included	550.CS.2M.04 Metalliche/Metallic Vaschetta portacancelleria inclusa / Stationery tray included	

Note: Per portacancelleria cassetti e cartelle sospese, vedi catalogo Pedestals\_DV550 / For stationary tray and hanging folders, see Pedestals\_DV550 catalogue

Note:  
 1 Le finiture in cuoio non sono in pronta consegna. Per la disponibilità contattare l'ufficio commerciale/Leather finishes are not in prompt delivery. Please contact the commercial department to check availability;  
 2 Le dimensioni sono espresse in cm - consultare il listino prezzi per le caratteristiche tecniche, i codici degli articoli e delle finiture/Dimensions are stated in cm - for technical characteristics, article code numbers and finishing see price list;  
 3 Cuoio/Leather;  
 4 Con serratura/With lock;  
 5 Modesty panel non integrabile ai tavoli 914.TI.23.16\_ /Desk tables 914.TI.23.16\_ cannot be integrated with the modesty panel.

Modesty panel per tavoli scrivania / Modesty panel for desk tables

P 1,8 x H 35 	P 2 x H 35 	P 2 x H 35 	P 1,8 x H 35 	P 2 x H 35 
914.MP.01.18_ L 120 Tavoli/Desks L 180 914.MP.01.20_ L 140 Tavoli/Desks L 200 914.MP.01.25_ L 140 Tavoli/Desks L 250	914.MP.01.18_ L 120 Tavoli/Desks L 180	914.MP.01.20_ L 140 Tavoli/Desks L 200 914.MP.01.25_ L 140 Tavoli/Desks L 250	914.MP.01.16_ L 100 Tavoli/Desks L 160	914.MP.01.16_ L 100 Tavoli/Desks L 160

Modesty panel per tavoli su mobili di servizio o moduli base Milo\_DV504 / Modesty panel for desk tables on service unit or modules Milo\_DV504 series

P 1,8 x H 35 	P 2 x H 35 	P 1,8 x H 35 	P 2 x H 35 
914.MP.21.18_ L 100 Tavoli+MS-DV504/Desks+SU-DV504 L 180 914.MP.21.20_ L 120 Tavoli+MS-DV504/Desks+SU-DV504 L 200 914.MP.21.25_ L 120 Tavoli+MS-DV504/Desks+SU-DV504 L 250	914.MP.21.18_ L 100 Tavoli+MS-DV504/Desks+SU-DV504 L 180 914.MP.21.20_ L 120 Tavoli+MS-DV504/Desks+SU-DV504 L 200 914.MP.21.25_ L 120 Tavoli+MS-DV504/Desks+SU-DV504 L 250	914.MP.21.16_ L 100 Tavoli+MS-DV504/Desks+SU-DV504 L 160	914.MP.21.16_ L 100 Tavoli+MS-DV504/Desks+SU-DV504 L 160

Note: Modesty panel non integrabile ai tavoli 914.TI.23.16\_ /Desk tables 914.TI.23.16\_ cannot be integrated with the modesty panel.

Accessori per canalizzazione - Elettrificazione - Vari/Accessories for wire management - Electrification - Various

914.AP.01.16 L 100 Tavoli/Desks L 160 914.AP.01.18 L 120 Tavoli/Desks L 180 914.AP.01.20 L 140 Tavoli/Desks L 200 914.AP.01.25 L 140 Tavoli/Desks L 250	914.AP.01.10_ L 60 Tavoli/Desks L 100	914.AP.02.16 L 100 Tavoli/Desks L 160 914.AP.02.20 L 140 Tavoli/Desks L 200 914.AP.02.25 L 140 Tavoli/Desks L 250	914.AP.02.24 L 180 Tavoli/Desks L 240	914.AP.51.16 L 80 Tavoli+DV504/Desks+DV504 L 160 - 914.TI.23.16_ 914.AP.01.16 L 100 Tavoli+MS-DV504/Desks+SU-DV504 L 160 - 914.TI.22.16_ 914.AP.51.18 L 100 Tavoli+MS-DV504/Desks+SU-DV504 L 180 914.AP.51.20 L 120 Tavoli+MS-DV504/Desks+SU-DV504 L 200 914.AP.51.25 L 120 Tavoli+MS-DV504/Desks+SU-DV504 L 250				

Bracci porta video/Arms for video support

300.AC.02.01 Braccio porta video mobile su piano / Dynamic arm for video support on deskbase	300.AC.02.02 Doppio braccio porta video mobile su piano / 2 dynamic arms for video support on deskbase	300.AC.01.01 Braccio porta video statico su palo / Static arm for video support on pole	300.AC.01.02 Doppio braccio porta video statico su palo / 2 Static arms for video support on pole

Accessori /Accessorie

L 90 P 60 x H 2

300.AS.01.09\_

Note:  
 1 Le dimensioni sono espresse in cm - consultare il listino prezzi per le caratteristiche tecniche, i codici degli articoli e delle finiture/Dimensions are stated in cm - for technical characteristics, article code numbers and finishing see price list;  
 2 Per la scelta dei contenitori e degli accessori vari, consultare il relativo listino o catalogo/To choose storage units and accessories, please check correspondent price list or catalogue;  
 3 Cuoio/Leather;  
 4 Prodotti non in pronta consegna. Per la disponibilità contattare l'ufficio commerciale/Items not in prompt delivery. Please contact the commercial department to check availability;  
 5 Articoli prodotti solo su richiesta/Items produced only on demand;

# Oslo

DV817

Semplicità ed essenzialità, con un design incisivo e riconoscibile, rendono questa linea operativa attuale e simpatica. Oslo è facilmente adattabile in qualsiasi spazio di lavoro, nel quale assume un ruolo da vera protagonista e risponde concretamente ai principi di ergonomia e funzionalità del proprio posto di lavoro.

*Simplicity and essentiality, with an incisive and recognizable design, give to this operative range a contemporary and pleasant outlook. Oslo is easy adaptable to any kind of working space, in which it becomes the true protagonist and responds to the principle of ergonomics and functionality of your workplace.*











Focus sugli accessori "optionals": canalizzazione orizzontale, verticale e modesty panel.



*Focus on the optional accessories: horizontal, vertical wire management, and modesty panel.*











I "Contenitori Integrati", serie Rio, permettono di configurare i posti di lavoro in modo personalizzato.

*The "Integrated storage units", Rio series, allow workplaces to be individually configured.*











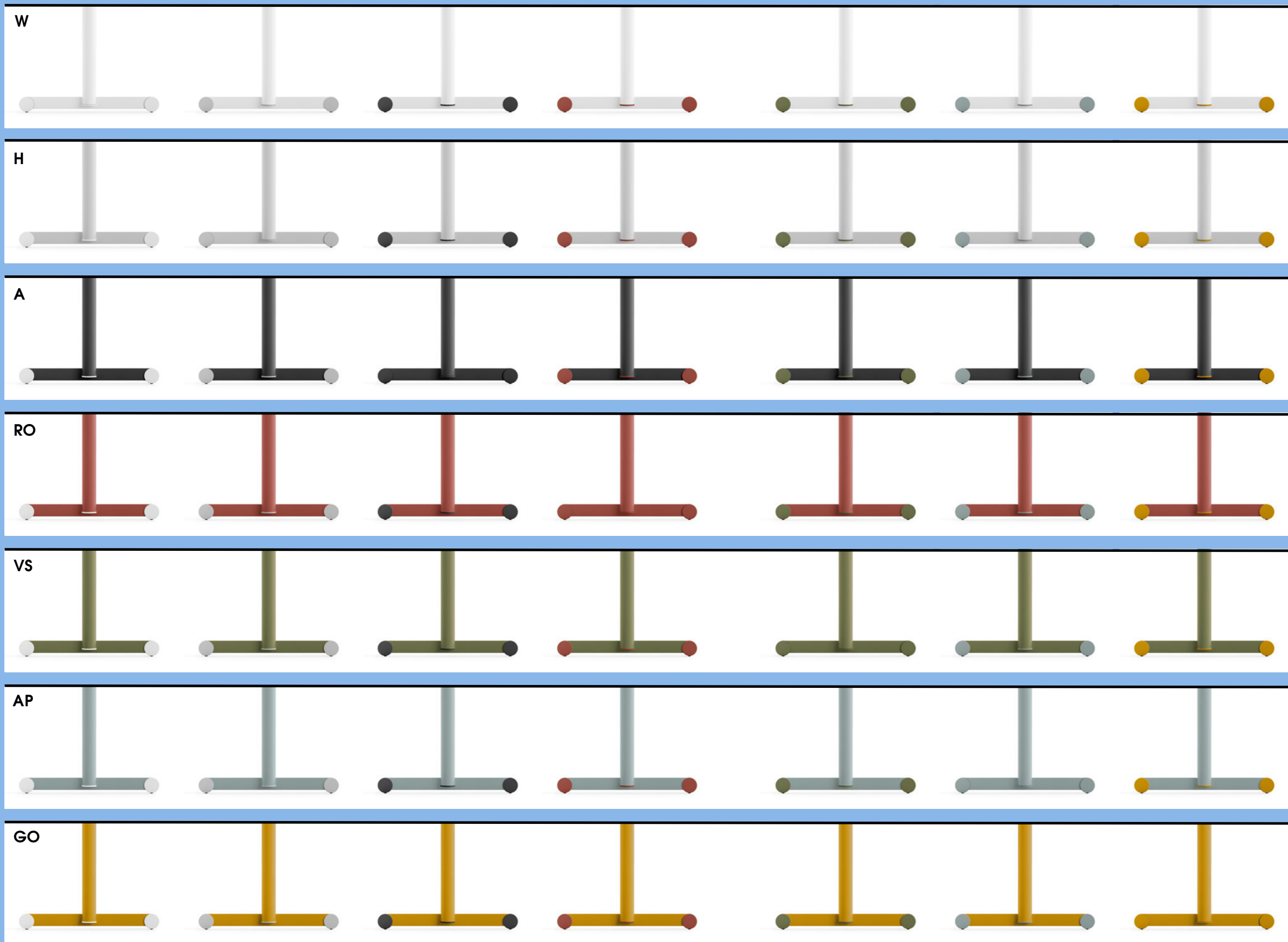

Le gambe metalliche sono disponibili nelle 7 finiture: bianco, alluminio, antracite, azzurro polvere, rosso mattone, verde salvia e giallo oro. È possibile abbinare i piedini colorati in ABS, nelle stesse finiture delle gambe, oppure in contrasto creando fino a 49 varianti cromatiche, per rendere più accattivante e giocoso l'arredo ufficio.

The metal legs are available in 7 finishes: white, aluminium, anthracite, powder blue, brick red, sage green and gold yellow. It is possible to combine the coloured ABS feet, in the same finishes of the leg or in contrast, creating up to 49 types of colour variants to make the office furniture more attractive and playful.

Tavoli / Tables

Piani di lavoro sp. 2,5 cm, in melaminico con bordi perimetrali in ABS sp. 0,2 cm / Worktops 2,5 cm thick, in melamine with 0,2 cm ABS edge-profiles



Modesty panel

Sp. 1,8 cm, in melaminico / 1,8 cm thick, in melamine



Gambe metalliche / Metal legs



Piedini in ABS / ABS feet



Mobili di servizio / Service units

Scocca e ripiani sp. 1,8 cm, in melaminico / Bodies and shelves 1,8 cm thick, in melamine

Ante scorrevoli sp. 1,8 cm, in melaminico con bordo ABS sp. 0,15 cm colore alluminio / Sliding doors 1,8 cm thick, in melamine with aluminium-coloured ABS edge-profiles 0,15 cm thick

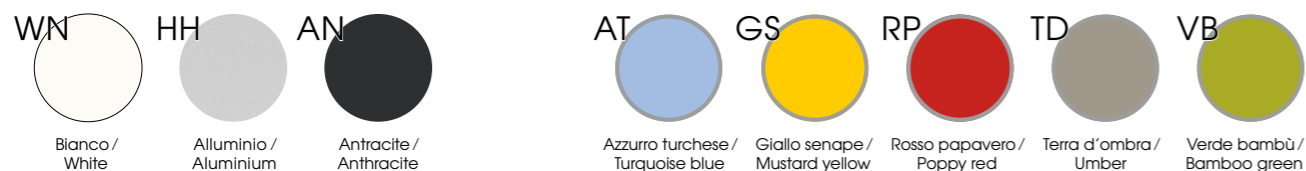

Ante scorrevoli sp. 1,8 cm, in melaminico con bordo ABS sp. 0,15 cm in tinta / Sliding doors 1,8 cm thick, in melamine with ABS edge-profiles 0,15 cm thick, in same color



Note

Prodotti non in pronta consegna. Per la disponibilità contattare l'ufficio commerciale. / Items not in prompt delivery. Please contact the commercial department to check availability. Per tutte le altre finiture consultare i relativi capitoli all'interno del listino prezzi. / For all other finishes, please refer to the relevant chapters in the price list.

FOCUS

- Montaggio veloce con solo 4 viti
- Trave ad innesto rapido
- Ampia gamma di combinazioni cromatiche

- Quick assembly with only 4 screws
- Quick-connect beam
- Wide range of color combinations



Piani di lavoro in melaminico sp. 25 mm con bordi perimetrali in ABS / Worktops in melamine 1" thick with perimetrical edges in ABS

Tavoli scrivania / Desks

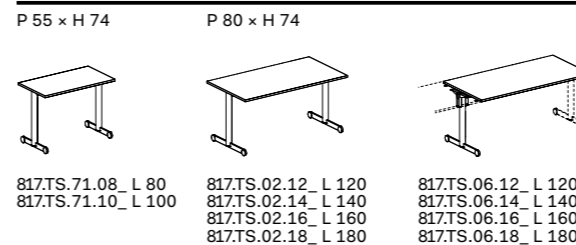

Tavoli P 166,5 a 2 scrivanie contrapposte / Benches 166,5 depth

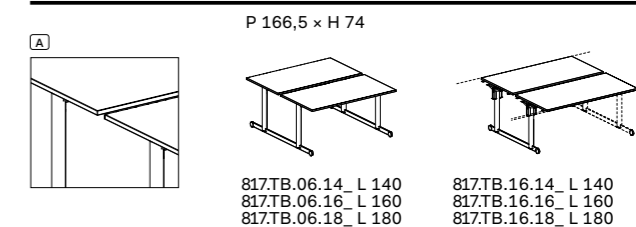

Allunghi laterali (Dx - Sx) / Lateral extension (R - L)

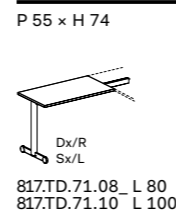

Tavolini caffè / Coffee tables



Tavoli alti H 107 / Standing tables H 107

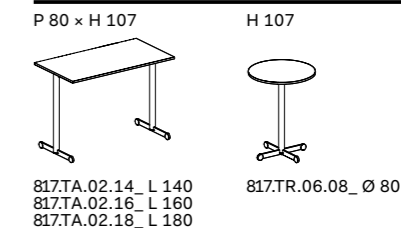

Allunghi su cassettiere portanti / Extensions on carrying pedestals

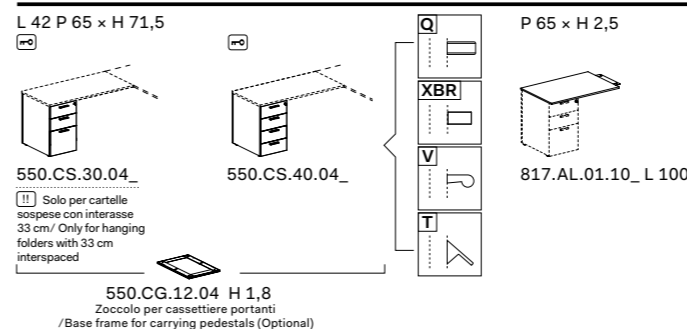

Contenitori H 74 / Storage units H 74

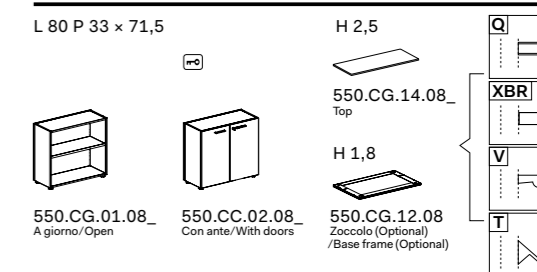

Cassettiere / Pedestals

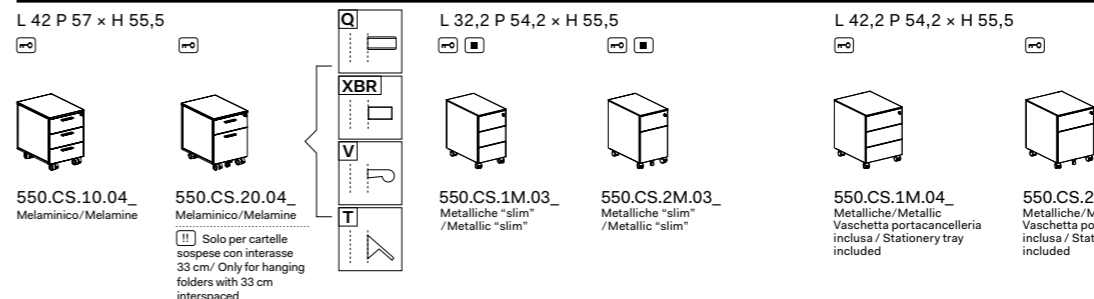

Note: Per portacancelleria cassetti e cartelle sospese, vedi catalogo Pedestals\_DV550 / For stationary tray and hanging folders, see Pedestals\_DV550 catalogue

Mobili di servizio con ante scorrevoli / Service units with sliding doors

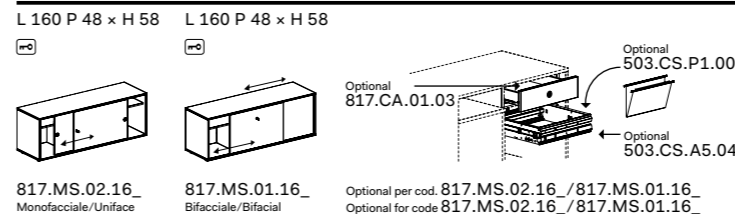

Tavoli integrabili su mobile di servizio / Integrable desks for service unit

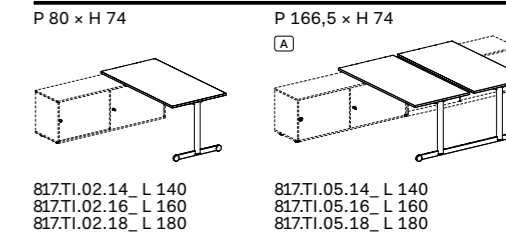

Note:

Le dimensioni sono espresse in cm - consultare il listino prezzi per le caratteristiche tecniche, i codici degli articoli e delle finiture / Dimensions are stated in cm - for technical characteristics, article code numbers and finishing see price list;

Prodotti non in pronta consegna. Per la disponibilità contattare l'ufficio commerciale / Items not in prompt delivery. Please contact the commercial department to check availability;

Senza binario / Without rail; Con serratura / With lock;

Piani di lavoro in melaminico sp. 25 mm con bordi perimetrali in ABS/Worktops in melamine 1" thick with perimetrical edges in ABS

Tavoli scrivania per integrazioni con contenitori Rio\_DV505 H= 74, 115, 164,5 /Integrable desks with storage unit Rio\_DV505 H= 74, 115, 164,5

**P 80 x H 74**  
  
 817.TI.24.14\_ L 140  
 817.TI.24.16\_ L 160  
 817.TI.24.18\_ L 180

**P 166,5 x H 74**  
  
 817.TI.25.14\_ L 140  
 817.TI.25.16\_ L 160  
 817.TI.25.18\_ L 180

**Note:** Kit staffe compreso nel codice./Brackets kit included in the code. Ordinare a parte i moduli contenitori integrati H= 74, 115, 164,5 e relativi accessori, consultare il listino Rio\_DV505 /Order the H= 74, 115, 164,5 integrated storage unit and related accessories separately, see Rio\_DV505 price list

Tavoli scrivania per integrazioni su orgatower Rio\_DV505 H= 74-115 /Integrable desks on Rio\_DV505 orgatower H= 74-115

**P 80 x H 74**  
  
 817.TI.26.14\_ L 140  
 817.TI.26.16\_ L 160  
 817.TI.26.18\_ L 180

**P 166,5 x H 74**  
  
 817.TI.27.14\_ L 140  
 817.TI.27.16\_ L 160  
 817.TI.27.18\_ L 180

**Note:** Kit staffe compreso nel codice./Brackets kit included in the code. Ordinare a parte gli orgatower H= 74 o 115, con top sp. 2,5. /Order the H= 74 or 115 orgatower, with 2,5 top, separately.

Orgatower con top sp. 2,5/Orgatower with 2,5 thick top

**L 42 P 80 x H 74**  
  
 505.TW.02.03\_

**L 42 P 80 x H 115**  
  
 505.TW.04.03\_

**Note:** Per l'integrazione con i tavoli Oslo\_DV817./For the integration with Oslo\_DV817 desk tables;

Modesty panels

**P 1,8 x H35**  
  
 817.MP.01.12\_ L 107 Tavoli/Desks L 120  
 817.MP.01.14\_ L 127 Tavoli/Desks L 140  
 817.MP.01.16\_ L 147 Tavoli/Desks L 160  
 817.MP.01.18\_ L 167 Tavoli/Desks L 180

Tavoli riunione/Conference tables

**L 200 P 100 x H 74**  
  
 817.TR.32.20\_

**L 240 P 120 x H 74**  
  
 817.TR.32.24\_

**L 250 P 125 x H 74**  
  
 817.TR.34.25\_

**H 74**  
  
 817.TR.01.10\_ Ø 100  
 817.TR.01.12\_ Ø 120

**L 200 P 100 x H 74**  
  
 817.TR.02.20\_

**L 240 P 120 x H 74**  
  
 817.TR.02.24\_

**L 250 P 125 x H 74**  
  
 817.TR.04.25\_

Morsetti e supporti per frontal panels Sp. 0,5 - 0,8 - 1 - 3 / Clamps for frontal panels T. 0,5 - 0,8 - 1 - 3

**N** 300.FP.27.00 Per piani /For worktops

**N** 300.FP.28.00 Per piani /For worktops

**N** 300.FP.33.00 Free standing per piani /Free standing for worktops

**Z** 300.FP.10.00 Per piani /For worktops

**Z** 300.FP.22.00 Per piani /For worktops

**Z** 300.FP.33.00 Free standing per piani /Free standing for worktops

Per frontal panels/For frontal panels (FP1) (FP65) (FPP) (FP08) (FPC1) (FPC2)

Note:

1 Le dimensioni sono espresse in cm - consultare il listino prezzi per le caratteristiche tecniche, i codici degli articoli e delle finiture/Dimensions are stated in cm - for technical characteristics, article code numbers and finishing see price list;

Prodotti non in pronta consegna. Per la disponibilità contattare l'ufficio commerciale/Items not in prompt delivery. Please contact the commercial department to check availability;

A Senza binario/Without rail;

N Morsetti o supporti in nylon /Nylon clamps  
 Z Morsetti o supporti in ZAMA / Zamak clamps  
 P Plexiglass  
 V Vetro/Glass.

Frontal panels sp. 1 - sp. 0,8

**P 1 x H 39**  
 300.FP.06.06\_ L 64  
 300.FP.06.07\_ L 79  
 300.FP.06.09\_ L 99  
 300.FP.06.11\_ L 119  
 300.FP.06.13\_ L 139  
 300.FP.06.15\_ L 159  
 300.FP.06.17\_ L 179  
 300.FP.06.19\_ L 199  
 Melaminico/Melamine

**P 0,8 x H 39**  
 300.FPV1.06\_ L 64  
 300.FPV1.07\_ L 79  
 300.FPV1.09\_ L 99  
 300.FPV1.11\_ L 119  
 300.FPV1.13\_ L 139  
 300.FPV1.15\_ L 159  
 300.FPV1.17\_ L 179  
 300.FPV1.19\_ L 199  
 Vetro/Glass

Frontal panel fonoassorbenti sp. 3 /Acoustic frontals panels t. 3

**P 3 x H 39**  
 300.FP.40.06\_ L 64  
 300.FP.40.07\_ L 79  
 300.FP.40.09\_ L 99  
 300.FP.40.11\_ L 119  
 300.FP.40.13\_ L 139  
 300.FP.40.15\_ L 159  
 300.FP.40.17\_ L 179  
 Tessuto/Fabric

**P 3 x H 59**  
 300.FP.50.13\_ L 139  
 300.FP.50.15\_ L 159  
 Tessuto/Fabric

Frontal panels H. 65

**P 1 x H 65**  
 300.FP.09.06\_ L 64  
 300.FP.09.07\_ L 79  
 300.FP.09.09\_ L 99  
 300.FP.09.11\_ L 119  
 300.FP.09.13\_ L 139  
 300.FP.09.15\_ L 159  
 300.FP.09.17\_ L 179  
 300.FP.09.19\_ L 199  
 Melaminico/Melamine

**P 0,5 x H 65**  
 300.FP.69.06 L 64  
 300.FP.69.11 L 119  
 300.FP.69.13 L 139  
 300.FP.69.15 L 159  
 Plexiglass

N.B.: Per i frontal con lunghezza maggiore o uguale ai 139 cm, ordinare 2 kit di supporti per frontal panel / Note: For frontal panels with a length greater than or equal to 139 cm, order 2 kits of clamps-supports for frontal panels

Accessori /Accessories

**L 6,5 P 6,5 x H 8,5**  
 300.FA.01.01

**L 50 P 17 x H 3**  
 300.FA.02.05

**L 31 P 22 x H 5**  
 300.FA.04.03

**L 23 P 10 x H 29**  
 300.FA.06.02

**L 35 P 6,5 x H 30**  
 300.FA.08.03

**Note:** Il posizionamento degli accessori sui frontal panel in vetro prevede l'utilizzo di una guarnizione in PVC trasparente (Optional su richiesta)/Placement of accessories on glass front panel need the use of a transparent PVC gasket (Optional on request) Non utilizzabile su frontal panels in plexiglass e frontal panels in tessuto fonoassorbente /Not usable for plexiglass frontal panels and acoustic frontal panels

Canalizzazione - Elettrificazione/Wire management - Electrification

**H 9**  
 817.AP.01.08 L 55 Tavoli/Desks L 80  
 817.AP.01.10 L 55 Tavoli/Desks L 100  
 817.AP.01.12 L 95 Tavoli/Desks L 120  
 817.AP.01.14 L 95 Tavoli/Desks L 140  
 817.AP.01.16 L 135 Tavoli/Desks L 160  
 817.AP.01.18 L 135 Tavoli/Desks L 180

**AP.15 series:**  
 300.AP.15.04 L 45 Tavoli/Desks L 80  
 300.AP.15.05 L 58 Tavoli/Desks L 100  
 300.AP.15.07 L 78 Tavoli/Desks L 120  
 300.AP.15.10 L 100 Tavoli/Desks L 140  
 300.AP.15.11 L 110 Tavoli/Desks L 160  
 300.AP.15.14 L 140 Tavoli/Desks L 180

**AP.08.05 H 55**  
 817.AP.08.05 H 55 Per gambe terminali /For terminal legs

**AP.28.04 H 40**  
 817.AP.28.04 H 40 Per gambe intermedie /For middle legs

**AP.01 series:**  
 300.AP.V1.00  
 300.AP.T2.01 Ø 8  
 300.AP.T7.01 Ø 6  
 300.AP.T8.01 Ø 8  
 300.AP.F1.00

**L 32 x P 12,3**  
 300.AC.38.02\_H 2,4  
 300.AC.67.03 Marsupio per top access 300.AC.38.02 / Basket for top access 300.AC.38.02

**AC.26 series:**  
 300.AC.26.02 L 24,5  
 300.AC.26.03 L 34,5  
 300.AC.26.04 L 44,5

**AC.20 series:**  
 300.AC.20.02\_ L 24,5  
 300.AC.20.03\_ L 34,5  
 300.AC.20.04\_ L 44,5

**AC.25 series:**  
 300.AC.25.02 L 23,5  
 300.AC.25.03 L 33,5  
 300.AC.25.04 L 43,5  
 Marsupio/Basket

**AP.S1 series:**  
 300.AP.S1.02 L 20,5  
 300.AP.S1.03 L 30  
 300.AP.S1.04 L 42  
 Per/For top access 300.AC.26\_

**AT.A6 series:**  
 300.AT.A6.02 L 21  
 300.AT.A6.03 L 25,5  
 300.AT.A6.04 L 39

**Ø 8**  
 300.AP.T8.11  
 300.AP.T8.14  
 300.AP.T8.17  
 300.AP.T8.20

**APT series:**  
 300.APT4.01  
 300.APT5.01 - UK  
 300.APT6.01 - US

**AC.06.05**  
 300.AC.06.05

Bracci porta video/Arms for video support

**AC.02 series:**  
 300.AC.02.01 Braccio porta video mobile su piano /Dynamic arm for video support on deskbase  
 300.AC.02.02 Doppio braccio porta video mobile su piano/2 dynamic arms for video support on deskbase

**AC.01 series:**  
 300.AC.01.01 Braccio porta video statico su palo/Static arm for video support on pole  
 300.AC.01.02 Doppio braccio porta video statico su palo/2 static arms for video support on pole

Note:

1 Le dimensioni sono espresse in cm - consultare il listino prezzi per le caratteristiche tecniche, i codici degli articoli e delle finiture/Dimensions are stated in cm - for technical characteristics, article code numbers and finishing see price list;

2 Per la scelta dei contenitori e degli accessori vari, consultare il relativo listino o catalogo/To choose storage units and accessories, please check correspondent price list or catalogue;

E Fino ad esaurimento/Until exhaustion;

Prodotti non in pronta consegna. Per la disponibilità contattare l'ufficio commerciale/Items not in prompt delivery. Please contact the commercial department to check availability;

Articoli prodotti solo su richiesta/Items produced only on demand;

# Toledo

DV818

Ricerca estetica e tecnologica che supera le tendenze tradizionali e punta su soluzioni fortemente innovative dando nuovi impulsi e possibilità alla creatività. Tavoli singoli o bench con strutture metalliche regolabili in altezza elettricamente, possono essere accessoriati e rispettano le normative vigenti.

*Aesthetic and technological research that overcomes traditional trends and focuses on highly innovative solutions giving new impulses and possibilities to creativity. Single tables or bench desks with metal structures, electrically adjustable in height, can be equipped and comply with current regulations.*









Trave telescopica canalizzabile / Ductable telescopic beam



Tastierino per regolazione altezza piano con 4 memorie / Control pad with four memories for height adjustable worktop



Bench con regolazione altezza elettrica, da 61,5 a 127,5 cm / Bench with electric height adjustment, from 24 1/4" to H 50 3/16"

Tavoli / Tables

Piani di lavoro sp. 2.5 cm, in melaminico con bordi perimetrali in ABS sp. 0.2 cm / Worktops 2.5 cm thick, in melamine with 0.2 cm ABS edge-profiles



Strutture metalliche / Metal structures

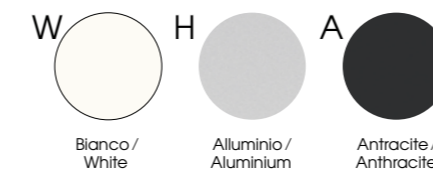

Note

Per tutte le altre finiture consultare i relativi capitoli all'interno del listino prezzi. / For all other finishes, please refer to the relevant chapters in the price list.



Piani di lavoro in melaminico sp. 25 mm con bordi perimetrali in ABS / Worktops in melamine 1" thick with perimetrical edges in ABS

Tavoli scrivania regolabili in altezza a tre stadi elettricamente (tipo A)  
/ Desks adjustable in H electrical at three stages (type A)

Tavoli scrivania / Desks

**E**

P 65 x H 64,5 ÷ 130 **A**+

P 80 x H 64,5 ÷ 130 **A**+

818.TS.57.14\_L 140  
818.TS.57.16\_L 160  
818.TS.57.18\_L 180

818.TS.58.14\_L 140  
818.TS.58.16\_L 160  
818.TS.58.18\_L 180

Note: Tavoli compresi di trave sottopiano telescopica canalizzabile. / Tables including ductable telescopic beam under worktop.

Tavoli a 2 scrivanie contrapposte / Benches

P 136,5 x H 61,5 ÷ 127,5 **A**+

P 166,5 x H 61,5 ÷ 127,5 **A**+

818.TB.32.14\_L 140  
818.TB.32.16\_L 160  
818.TB.32.18\_L 180

818.TB.33.14\_L 140  
818.TB.33.16\_L 160  
818.TB.33.18\_L 180

Note: Tavoli compresi di trave sottopiano telescopica canalizzabile. / Tables including ductable telescopic beam under worktop.

Tavoli indipendenti con allunghi laterali (Dx - Sx)  
/ Independent desks with lateral extension (R - L)

P 165 x H 64,5 ÷ 130 **A**+

P 180 x H 64,5 ÷ 130 **A**+

818.TD.50.14\_L 140  
818.TD.50.16\_L 160  
818.TD.50.18\_L 180

818.TD.51.14\_L 140  
818.TD.51.16\_L 160  
818.TD.51.18\_L 180

Bench con allunghi laterali (Dx - Sx)  
/ Benches with lateral extension (R - L)

P 236,5 x H 61,5 ÷ 127,5 **A**+

P 266,5 x H 61,5 ÷ 127,5 **A**+

818.TD.52.14\_L 140  
818.TD.52.16\_L 160  
818.TD.52.18\_L 180

818.TD.53.14\_L 140  
818.TD.53.16\_L 160  
818.TD.53.18\_L 180

Bench con 2 allunghi laterali (Dx - Sx) / Benches with 2 lateral extensions (R - L)

P 336,5 x H 61,5 ÷ 127,5 **A**+

P 366,5 x H 61,5 ÷ 127,5 **A**+

818.TD.54.14\_L 140  
818.TD.54.16\_L 160  
818.TD.54.18\_L 180

818.TD.55.14\_L 140  
818.TD.55.16\_L 160  
818.TD.55.18\_L 180

Bracci porta video / Arms for video support

300.AC.02.01 Braccio porta video mobile su piano / Dynamic arm for video support on deskbase

300.AC.02.02 Doppio braccio porta video mobile su piano / 2 dynamic arms for video support on deskbase

300.AC.01.01 Braccio porta video statico su palo / Static arm for video support on pole

300.AC.01.02 Doppio braccio porta video statico su palo / 2 static arms for video support on pole

Modesty panels / Modesty panel

P 1,8 x H35

818.MP.01.14\_L 127  
818.MP.01.16\_L 147  
818.MP.01.18\_L 167  
Per tavoli / For desks

Cassettiere / Pedestals

L 42 P 57 x H 55,5

L 32,2 P 54,2 x H 55,5

L 42,2 P 54,2 x H 55,5

550.CS.10.04\_Melaminico/Melamine

550.CS.20.04\_Melaminico/Melamine

550.CS.1M.03\_Metalliche "slim" / Metallic "slim"

550.CS.2M.03\_Metalliche "slim" / Metallic "slim"

550.CS.1M.04\_Metalliche/Metallic Vaschetta portacancelleria inclusa / Stationery tray included

550.CS.2M.04\_Metalliche/Metallic Vaschetta portacancelleria inclusa / Stationery tray included

Note: Per portacancelleria cassette e cartelle sospese, vedi catalogo Pedestals\_DV550 / For stationary tray and hanging folders, see Pedestals\_DV550 catalogue

Note:

1 Le dimensioni sono espresse in cm - consultare il listino prezzi per le caratteristiche tecniche, i codici degli articoli e delle finiture / Dimensions are stated in cm - for technical characteristics, article code numbers and finishing see price list;

2 Prodotti non in pronta consegna. Per la disponibilità contattare l'ufficio commerciale / Items not in prompt delivery. Please contact the commercial department to check availability;

3 Fino ad esaurimento / Until exhaustion;

A Senza binario / Without rail;

B Con serratura / With lock;

C Tastierino per regolazione altezza piano con memorie / Control pad with memories for height adjustable worktop

Frontal panels per bench  
/ Frontal panels for bench

P 2,5 x H 70

Tessuto / Fabric  
818.FR.21.14\_L 140  
818.FR.21.16\_L 160  
818.FR.21.18\_L 180

Per bench con altezza regolabile "tipo A"  
/ For bench with adjustable height "type A"

Morsetti e supporti per frontal panels Sp. 0,5 - 0,8 - 1 - 3  
/ Clamps for frontal panels T. 0,5 - 0,8 - 1 - 3

300.FP.27.00 Per piani / For worktops

300.FP.33.00 Free standing per piani / Free standing for worktops

300.FP.10.00 Per piani / For worktops

300.FP.33.00 Free standing per piani / Free standing for worktops

Per frontal panels / For frontal panels FP1 FP6S FPP FP08 FPC1 FPC2

Frontal panels sp. 1 - sp. 0,8

P 1 x H 39

P 0,8 x H 39

300.FP.06.07\_L 79  
300.FP.06.09\_L 99  
300.FP.06.13\_L 139  
300.FP.06.15\_L 159  
300.FP.06.17\_L 179  
Melaminico / Melamine

300.FPV.1.07\_L 79  
300.FPV.1.09\_L 99  
300.FPV.1.13\_L 139  
300.FPV.1.15\_L 159  
300.FPV.1.17\_L 179  
Vetro / Glass

300.FP.40.07\_L 79  
300.FP.40.09\_L 99  
300.FP.40.13\_L 139  
300.FP.40.15\_L 159  
300.FP.40.17\_L 179  
Tessuto / Fabric

Frontal panel fonoassorbenti sp. 3  
/ Acoustic frontals panels t. 3

P 3 x H 39

P 3 x H 59

300.FP.50.13\_L 139  
300.FP.50.15\_L 159  
Tessuto / Fabric

Frontal panels H. 65

P 1 x H 65

P 0,5 x H 65

300.FP.09.07\_L 79  
300.FP.09.09\_L 99  
300.FP.09.13\_L 139  
300.FP.09.15\_L 159  
300.FP.09.17\_L 179  
Melaminico / Melamine

300.FP.69.13\_L 139  
300.FP.69.15\_L 159  
Plexiglass

N.B.: Per i frontal con lunghezza maggiore o uguale ai 139 cm, ordinare 2 kit di supporti per frontal panel / Note: For frontal panels with a length greater than or equal to 139 cm, order 2 kits of clamps-supports for frontal panels

Accessori / Accessories

L 6,5 P 6,5 x H 8,5

L 50 P 17 x H 3

L 31 P 22 x H 5

L 23 P 10 x H 29

L 35 P 6,5 x H 30

300.FA.01.01

300.FA.02.05

300.FA.04.03

300.FA.06.02

300.FA.08.03

Note: Il posizionamento degli accessori sul frontal panel in vetro prevede l'utilizzo di una guarnizione in PVC trasparente (Optional su richiesta) / Placement of accessories on glass front panel need the use of a transparent PVC gasket (Optional on request)  
Non utilizzabile su frontal panels in plexiglass, frontal panels rivestiti in tessuto e frontal panels in tessuto fonoassorbente / Not usable for plexiglass frontal panels, fabric upholstered frontal panels and acoustic frontal panels

Canalizzazione - Elettrificazione / Wire management - Electrification

300.AP.V1.00

300.AP.F1.00

300.AP.T2.01 Ø 8

300.AP.T7.01 Ø 6  
300.AP.T8.01 Ø 8

300.AC.26.02 L 24,5  
300.AC.26.03 L 34,5  
300.AC.26.04 L 44,5

300.AC.20.02\_L 24,5  
300.AC.20.03\_L 34,5  
300.AC.20.04\_L 44,5

300.AC.25.02 L 23,5  
300.AC.25.03 L 33,5  
300.AC.25.04 L 43,5  
Marsupio / Basket

L 32 x P 12,3

300.AC.38.02\_H 2,4

300.AC.67.03 Marsupio per top access  
300.AC.38.02 / Basket for top access  
300.AC.38.02

300.AP.S1.02 L 20,5  
300.AP.S1.03 L 30  
300.AP.S1.04 L 42  
Per / For top access 300.AC.26\_

300.AT.A6.02 L 21  
300.AT.A6.03 L 25,5  
300.AT.A6.04 L 39

300.AP.T8.11  
300.AP.T8.14  
300.AP.T8.17  
300.AP.T8.20

300.APT.4.01  
300.APT.5.01 - UK  
300.APT.6.01 - US

818.KT.03.00 Kit unione bench in linea / In line bench connection kit

818.AP.10.00 Canalina per tavoli bench L=140-160-180 / Wire management for bench tables W=140-160-180

818.AP.43.00 Carter di copertura per canalina bench / Covering carter for bench wire channel

818.AP.10.09 L 94 Catena passacavi per bench. Canalina per bench 818.AP.10.00 obbligatoria. / Cable chain for bench. Wire management for bench 818.AP.10.00 mandatory.

818.AP.10.13 L 132 Catena passacavi per tavoli singoli. / Cable chain for independent desk tables.

818.AC.01.00 Porta cpu / Cpu holder

Note:

1 Le dimensioni sono espresse in cm - consultare il listino prezzi per le caratteristiche tecniche, i codici degli articoli e delle finiture / Dimensions are stated in cm - for technical characteristics, article code numbers and finishing see price list;

2 Per la scelta dei contenitori e degli accessori vari, consultare il relativo listino o catalogo / To choose storage units and accessories, please check correspondent price list or catalogue;

3 Prodotti non in pronta consegna. Per la disponibilità contattare l'ufficio commerciale / Items not in prompt delivery. Please contact the commercial department to check availability;

4 Articoli prodotti solo su richiesta / Items produced only on demand;

N Morsetti o supporti in nylon / Nylon clamps

Z Morsetti o supporti in ZAMA / Zamak clamps

P Plexiglass

V Vetro / Glass.

# dvo\_

**DVO S.R.L.** con unico socio  
Via XX Settembre, 272  
Casella Postale n. 65  
U.P. Roveredo in Piano  
33080 Roveredo in Piano (PN)  
Italy

Tel. +39 0434 386 111  
Fax +39 0434 386 112  
**www.dvo.it**  
**info@dvo.it**



**Graphic Design**  
dvo\_uff\_mkt

**Visual**  
Lone Studio  
Bruger Studio

**Print**  
Grafiche Antiga

**Printed in Italy**  
Issue 01  
October 2022



**Foto e testi copyright**  
DVO non riproducibili.  
La venditrice si riserva  
la facoltà di apportare  
al prodotto eventuali  
modifiche tecniche,  
dimensionali ed estetiche  
in qualsiasi momento  
senza preavviso.

Pictures and text are  
DVO copyright, duplicate  
forbidden. The selling  
Company reserves the  
right to introduce changes  
to products regarding  
sizes and aesthetical  
or technical aspects at  
any timewithout notice.

**Thanks to**  
Emmegi  
Rotaliana

DVO S.R.L. - AZIENDA CERTIFICATA / CERTIFIED COMPANY



Richiedi i prodotti certificati FSC® / Request for FSC® certified products

Il marchio della  
gestione forestale  
responsabile

# dvo\_

DVO S.R.L. con unico socio  
Via XX Settembre, 272  
Casella Postale n. 65  
U.P. Roveredo in Piano  
33080 Roveredo in Piano (PN)  
Italy

Tel. +39 0434 386 111  
Fax +39 0434 386 112  
[www.dvo.it](http://www.dvo.it)  
[info@dvo.it](mailto:info@dvo.it)

