

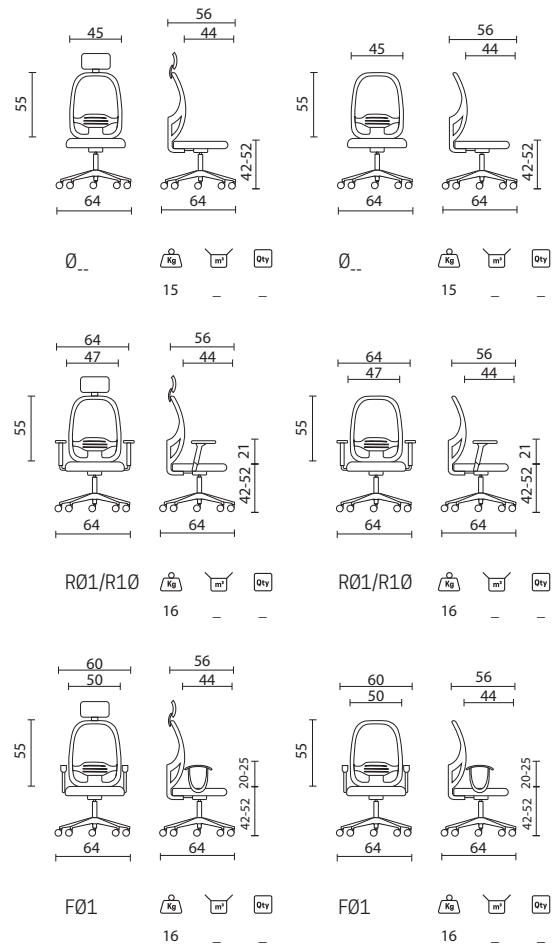

## DIMENSIONI



## CERTIFICAZIONI

### SEDIA OPERATIVA

#### POGGIATESTA

In rete regolabile in altezza e inclinazione.

#### SCHIENALE

In rete con struttura portante in nylon (PA) con supporto lombare regolabile in altezza.

#### SEDILE

Imbottito con resine espanse indeformabili, struttura interna in materiale plastico polipropilene (pp) con apposite nervature e barre di acciaio di rinforzo, carter esterno in materiale plastico polipropilene (pp).

#### BRACCIOLI

Disponibile nella tipologia fisso o regolabili 1D in altezza.

#### MECCANISMI

Disponibili due versioni dello stesso meccanismo:

Synchron 4 blocchi o 4 blocchi con trasla.

#### COLONNA A GAS

Meccanismo che permette la regolazione in altezza del sedile rivestito da un soffietto telescopico in materiale plastico polipropilene (PP).

#### BASE

Tipologia a cinque razze in nylon (PA) con apposite nervature di rinforzo, diametro 640 mm o metallica cromata diametro 640 mm.

#### RUOTE

Piroettanti a doppio battistrada morbido o duro diametro 50 mm, disponibili libere auto/frenanti.

#### TESSUTI E RETE

Disponibili in diverse tipologie e colorazioni presenti nelle cartelle rivestimenti LTFORM.

## RETI:

RETE P

RETE M

Disponibili in vari colori come da cartelle rivestimenti LT FORM

---

## BRACCIOLI



**F01**  
Braccioli fissi in PP neri  
- fissi in polipropilene



**R01**  
Braccioli regolabili 1D  
- regolabile in altezza

---

## MECCANISMI



**S01**  
Synchron 3 blocchi  
- Inclinazione schienale sedile  
- Regolazione intensità oscillazione  
- Regolazione altezza sedile



**S11**  
Synchron 4 blocchi con traslatore  
- 4 posizione di blocco  
- Inclinazione schienale sedile  
- Regolazione intensità oscillazione  
- Regolazione altezza sedile  
- Traslazione del sedile in avanti

---

## BASI



**B01**  
Base 5 razze Ø640 nylon nera



**B26**  
Base 5 razze Ø640 cromata.

---

## RUOTE



**R01** Ruote Ø50 Nylon  
**R02** Ruote stop Ø50 Nylon



**R03** Ruote gommate Ø50  
**R04** Ruote stop gommate Ø50



## DIMENSIONI

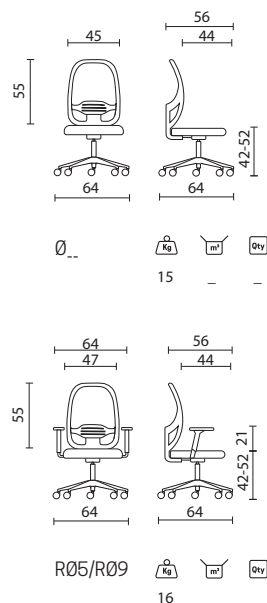

## CERTIFICAZIONI

### SEDIA OPERATIVA

#### SCHIENALE

In rete con struttura portante in nylon (PA) con supporto lombare regolabile in altezza.

#### SEDILE

Imbottito con resine espanse indeformabili, struttura interna in materiale plastico polipropilene (pp) con apposite nervature e barre di acciaio di rinforzo, carter esterno in materiale plastico polipropilene (pp).

#### BRACCIOLI

Disponibile nella tipologia regolabili 2D in altezza e traslazione in avanti o 4D in altezza, larghezza, rotazione e traslazione in avanti del top soft touch in PU.

#### MECCANISMI

Disponibili due versioni dello stesso meccanismo:  
Synchron 4 blocchi o 4 blocchi con trasla.

#### COLONNA A GAS

Meccanismo che permette la regolazione in altezza del sedile rivestito da un soffietto telescopico in materiale plastico polipropilene (PP).

#### BASE

Tipologia a cinque razze in nylon (PA) con apposite nervature di rinforzo, diametro 640 mm o metallica cromata diametro 640 mm.

#### RUOTE

Piroettanti a doppio battistrada morbido o duro diametro 50 mm, disponibili libere auto/frenanti.

#### TESSUTI E RETE

Disponibili in diverse tipologie e colorazioni presenti nelle cartelle rivestimenti LTFORM.

#### RETI:

RETE P

RETE M

Disponibili in vari colori come da cartelle rivestimenti LT FORM

## BRACCIOLI



**R09**  
Braccioli regolabili 2D bianchi



**R05**  
Braccioli regolabili 4D con pad in TPU.  
- In plastica regolabile in altezza  
- Regolabile in larghezza  
- Traslazione e rotazione del top soft touch in TPU

## MECCANISMI



**S01**  
Synchron 3 blocchi  
- Inclinazione schienale sedile  
- Regolazione intensità oscillazione  
- Regolazione altezza sedile



**S11**  
Synchron 4 blocchi con traslatore  
- 4 posizione di blocco  
- Inclinazione schienale sedile  
- Regolazione intensità oscillazione  
- Regolazione altezza sedile  
- Traslazione del sedile in avanti

## BASI



**B01**  
Base 5 razze Ø640 nylon nera



**B26**  
Base 5 razze Ø640 cromata.

## RUOTE



**R01** Ruote Ø50 Nylon  
**R02** Ruote stop Ø50 Nylon



**R03** Ruote gommate Ø50  
**R04** Ruote stop gommate Ø50

## Categoria/Category

### P



**W** Bianco / White



**A** Arancio / Orange

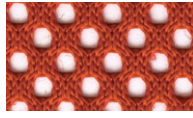

**R** Rosso / Red



**B** Blu / Blue

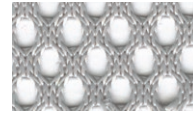

**G** Grigio / Grey

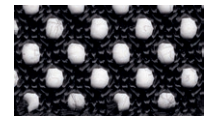

**N** Nero / Black



**S** Sabbia / Sand



**M** Marrone / Brown

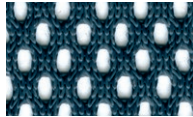

**D** Blu scuro / Dark blue

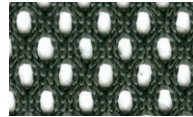

**P** Piombo / Lead

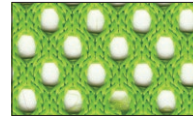

**V** Verde / Green

## Categoria/Category

### R

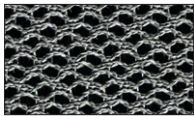

**RD** Grigio scuro / Dark grey

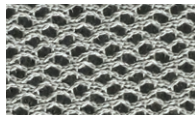

**RG** Grigio chiaro / Light grey



**RN** Nero / Black

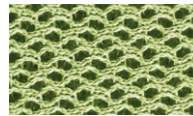

**RV** Verde / Green

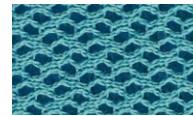

**RT** Turchese / Turquoise

## Categoria/Category

### M



**N1** Nero / Black

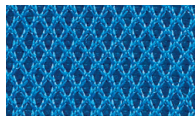

**N3** Blu / Blue grey



**N2** Arancio / Orange



**N4** Grigio / Grey

## Categoria/Category

### A (Solo per Accento)



**00** Nero / Black

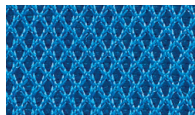

**02** Blu / Blue



**06** Arancio / Orange



**09** Grigio / Grey

## Categoria/Category

### N (Solo per Nimbus)



**NN** Nero / Black

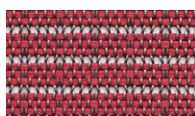

**NR** Rosso / Red

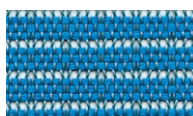

**NB** Blu / Blue

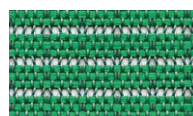

**NV** Verde / Green

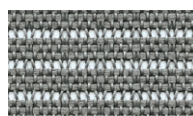

**NG** Grigio / Grey

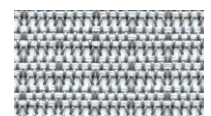

**NS** Bianco / White