

---

# DV990 Meet

dvo\_

**dvo\_**

**DV990-Meet**

Cod.	Pag.
DV990-Meet "Special Tables"	004
DV990-Meet "Executives Tables"	050
DV990-Meet "Workstations Tables"	108

# Special Tables

# DV990 Meet-Special Tables

Design:  
Antonio Morello

IT Una linea di tavoli riunione “speciali” che arricchisce e valorizza la gamma già esistente di tavoli, nelle nostre molteplici collezioni. Eleganti geometrie compositive, disegnano svariati e molteplici tavoli riunioni, così da poter arredare con funzionalità e prestigio qualsiasi ambiente di lavoro che necessiti di professionalità e comfort.

EN A line of “special” meeting tables which enriches the range of the existing ones, in our numerous collections. Elegant compositional geometries create a variety of meeting tables, so to furnish with functionality and prestige any meeting place that requires professionalism and comfort.





Market Search	Popular Markets	Cryptocurrencies	FX   Majors	EURUSD CFD
FX	AUDUSD CFD	0.71499	0.71507	0.71451
AUDUSD CFD (Hedge)	0.71499	0.71507	0.71451	
EURCHF CFD	1.14129	1.14149	1.13607	
EURGBP CFD	0.88875	0.88884	0.88844	
EURJPY CFD	131.504	131.513	130.966	
EURJPY CFD (Hedge)	131.504	131.513	130.966	
EURUSD CFD	1.15462	1.15468	1.15354	
EURUSD CFD (Hedge)	1.15461	1.15469	1.15356	
GBPEUR CFD	1.12501	1.12523	1.12120	
GBPJPY CFD	147.948	147.974	147.360	
GBPUSD CFD	1.29907	1.29916	1.29626	
GBPUSD CFD (Hedge)	1.29907	1.29916	1.29626	
NZDUSD CFD	0.65536	0.65548	0.65509	
NZDUSD CFD (Hedge)	0.65536	0.65548	0.65509	
USDCAD CFD	1.28331	1.28351	1.28666	
USDCAD CFD (Hedge)	1.28331	1.28351	1.28666	









































Tavoli/Tables 990.TR.C0.1A

Piani di lavoro sp. 2.5 cm, in melaminico o laminato (\*) con bordi in ABS sp. 0.2 cm / Worktops and legs 2.5 cm thick, in melamine or laminate (\*) with ABS edge-profiles 0.2 cm



Gambe in metallo/Metal legs

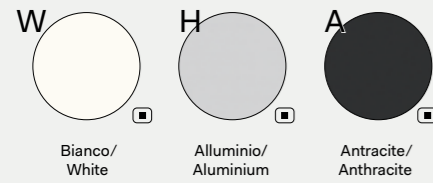

Tavoli/Tables 990.TR.C0.2A - 990.TR.C0.5A - 990.TR.C0.6C - 990.TR.C0.6D

Piani di lavoro e gambe sp. 3.8 cm, in melaminico con bordi in ABS sp. 0.2 cm / Worktops and legs 3.8 cm thick in melamine with ABS edge-profiles 0.2 cm thick  
Schiene sp.1.8 cm, in melaminico / Back panels 1.8 cm thick, in melamine

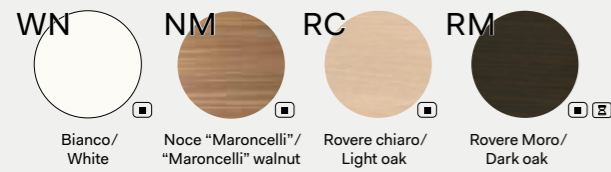

Top access in alluminio/ Aluminium Top access

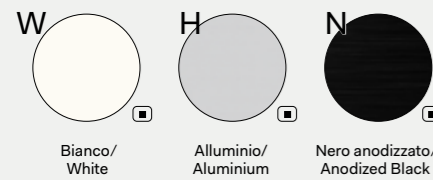

Tavoli/Tables 990.TR.C0.3A

Piani di lavoro sp. 2.5 cm, in melaminico o laminato (\*) con bordi in ABS sp. 0.2 cm / Worktops and legs 2.5 cm thick, in melamine or laminate (\*) with ABS edge-profiles 0.2 cm  
Schiene sp.1.8 cm, in melaminico o laminato (\*) / Back panels 1.8 cm thick, in melamine or laminate (\*)



Gambe in metallo/Metal legs

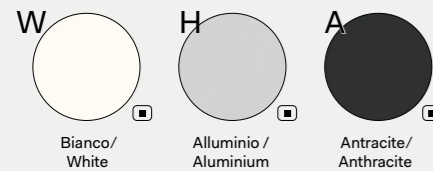

Note

■ Prodotti non in pronta consegna. Per la disponibilità contattare l'ufficio commerciale./Items not in prompt delivery. Please contact the commercial department to check availability.  
Ⓜ Fino ad esaurimento. / Until exhaustion.

Tavoli/Tables 990.TR.C0.4A

Piani di lavoro e gambe sp. 3.8 cm, in melaminico con bordi in ABS sp. 0.2 cm / Worktops and legs 3.8 cm thick in melamine with ABS edge-profiles 0.2 cm thick  
Schiene sp. 1.8 cm, in melaminico / Back panels 1.8 cm thick, in melamine  
Piano centrale con top access sp. 1.8 cm, in melaminico / Central worktops with top access 1.8 cm thick, in melamine

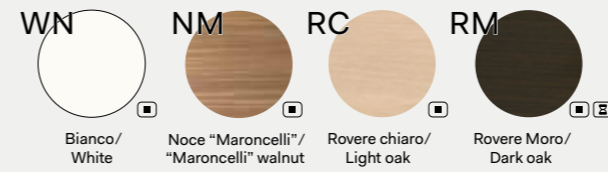

Top access in alluminio/ Aluminium Top access

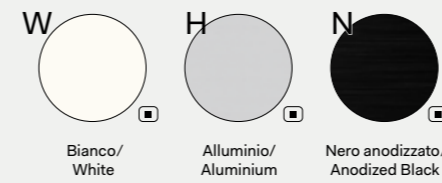

Tavoli/Tables 990.TR.C0.7A

Piani di lavoro sp. 2.5 cm, in melaminico o laminato (\*) con bordi in ABS sp. 0.2 cm / Worktops and legs 2.5 cm thick, in melamine or laminate (\*) with ABS edge-profiles 0.2 cm  
Piano centrale con top access sp. 1.8 cm, in melaminico o laminato (\*) / Central worktops with top access 1.8 cm thick, in melamine or laminate (\*)



Gambe in metallo/Metal legs

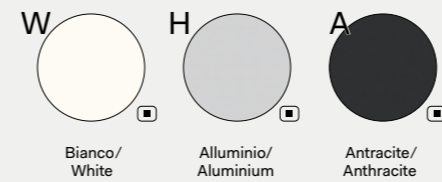

Top access in alluminio/ Aluminium Top access

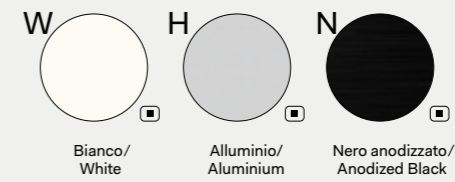

Tavoli/Tables 990.TR.C0.8A - 990.TR.C0.8B

Piani di lavoro sp. 2.5 cm, in melaminico con bordi in ABS sp. 0.2 cm / Worktops and legs 2.5 cm thick, in melamine with ABS edge-profiles 0.2 cm



Gambe in metallo/Metal legs

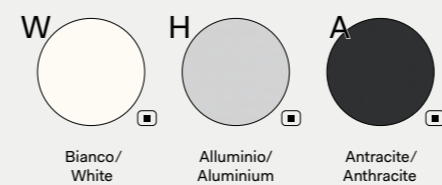

Modesty panel in tessuto tecnico/Technical fabric modesty panel

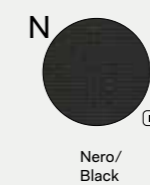

Note

■ Prodotti non in pronta consegna. Per la disponibilità contattare l'ufficio commerciale./Items not in prompt delivery. Please contact the commercial department to check availability.  
Ⓜ Fino ad esaurimento. / Until exhaustion.



Tavoli/Tables 990.TR.C0.9A

Piani di lavoro sp. 2.5 cm, in melaminico o laminato (\*) con bordi in ABS sp. 0.2 cm / Worktops and legs 2.5 cm thick, in melamine or laminate (\*) with ABS edge-profiles 0.2 cm  
 Schiene sp.1.8 cm, in melaminico o laminato (\*) / Back panels 1.8 cm thick, in melamine or laminate (\*)



Gambe in metallo/Metal legs

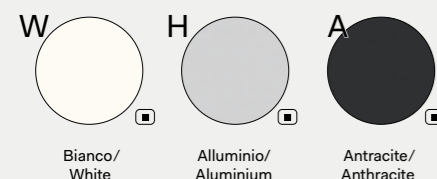

Top access in alluminio/ Aluminium Top access

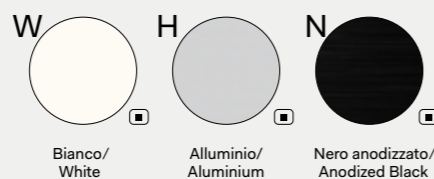

Tavoli/Tables 990.TR.C1.0A - 990.TR.C1.0B - 990.TR.C1.0C - 990.TR.C1.1A - 990.TR.C1.1B

Piani di lavoro sp. 3.8 cm, in melaminico con bordi in ABS sp. 0.2 cm / Worktops and legs 3.8 cm thick, in melamine with ABS edge-profiles 0.2 cm thick  
 Colonne sp. 2.5 cm, in melaminico / Columns 2.5 cm thick, in melamine



Top access in alluminio/ Aluminium Top access

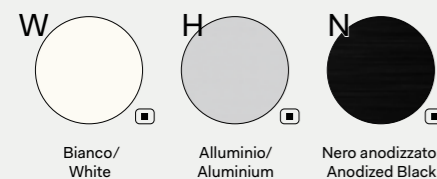

Note  
 □ Prodotti non in pronta consegna. Per la disponibilità contattare l'ufficio commerciale./Items not in prompt delivery. Please contact the commercial department to check availability.  
 ⊞ Fino ad esaurimento. / Until exhaustion.

Tavoli riunione speciali/Special meeting tables

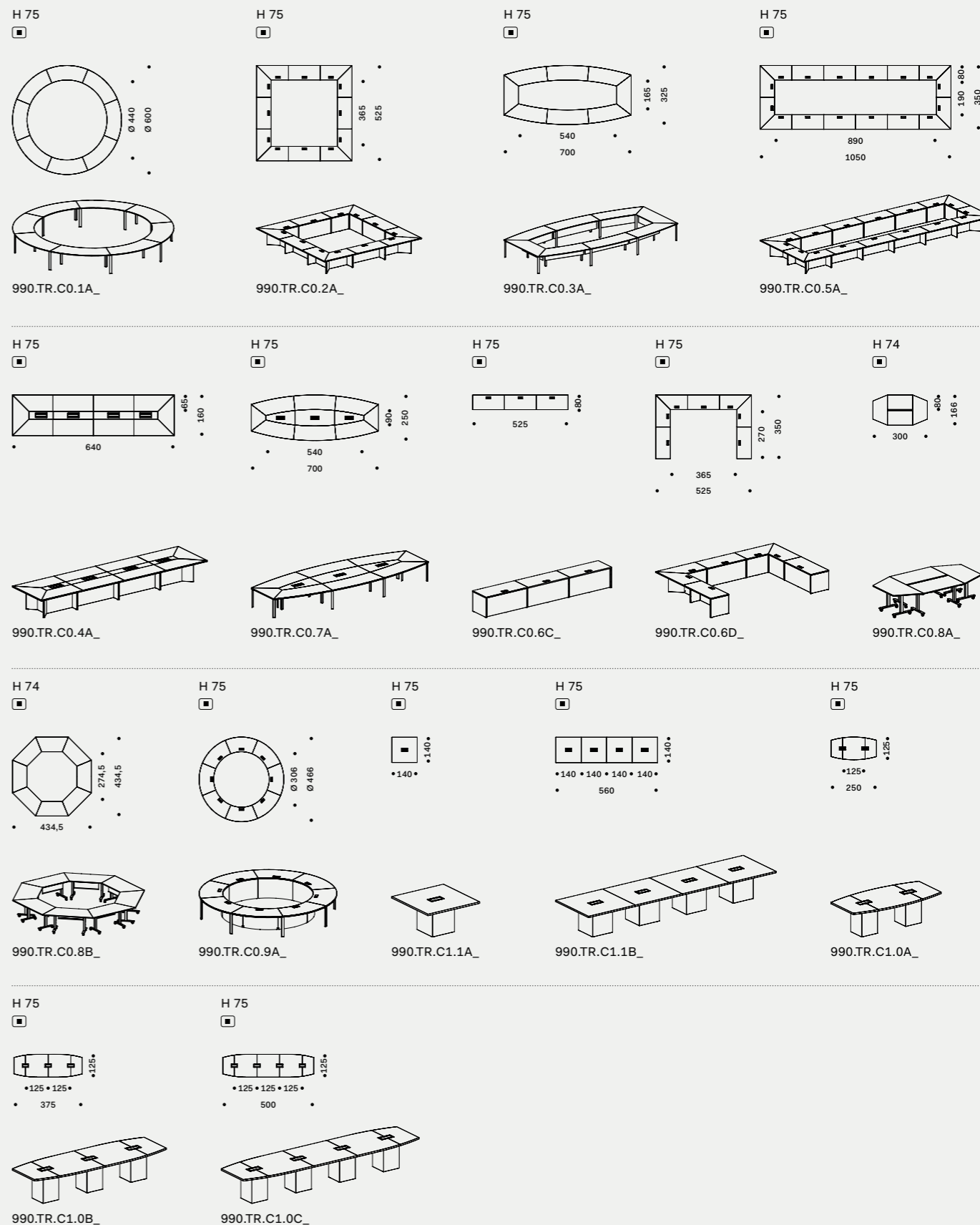

Note:  
 ① Le versioni dei tavoli riunione "speciali", fotografati con microfoni e monitor integrati, non sono disponibili a listino. Per eventuali richieste contattare l'ufficio commerciale /The "special" meeting tables, photographed with incorporated microphones and monitors, are not available in our price list. Please contact our commercial department in case of an enquiry;  
 ② Le dimensioni sono espresse in cm - consultare il listino prezzi per le caratteristiche tecniche, i codici degli articoli e delle finiture/Dimensions are stated in cm - for technical characteristics, article code numbers and finishing see price list;  
 □ Prodotti non in pronta consegna. Per la disponibilità contattare l'ufficio commerciale/Items not in prompt delivery. Please contact the commercial department to check availability.

# Executives Tables

# DV913 Vigo

Design:  
Baldanzi & Novelli

**IT** Scultoreo contrasto di pesi e volumi per i tavoli riunione DV913-Vigo, dove il tavolo è un'opera d'architettura in scala ridotta, minuzioso elemento di design in cui gli importanti spessori caratterizzano i fianchi e i robusti piani di lavoro.

**EN** Sculptural contrast of weights and volumes, a collection for executive offices where the table is a work of architecture on a reduced scale, a meticulous design element in which the important thickness characterizes the sides and the robust worktops.







Tavoli/Tables

Piani di lavoro sp. 5 cm, in melaminico/Worktops 5 cm thick, in melamine



Gambe in folding sp. 10 cm/Legs in folding 10 cm thick



Gambe in metallo/Metal legs

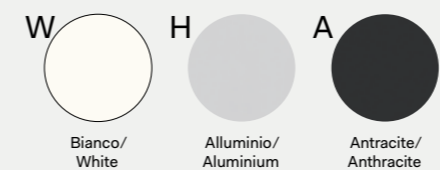

Note

▣ Prodotti non in pronta consegna. Per la disponibilità contattare l'ufficio commerciale./Items not in prompt delivery. Please contact the commercial department to check availability.

DV913 Vigo

Dati tecnici / Technical data

Tavoli riunione H. 75 cm con piani di lavoro interi in melaminico sp. 5 cm con bordi perimetrali in ABS / Meeting tables H.75 cm with whole worktops in melamine 5 cm thick with perimetrical edges in ABS

P 120 - H 75

Ø 140 - H 75

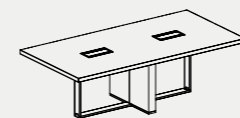

913.TR.41.24\_ L 240

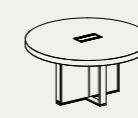

913.TR.11.14\_

Note: Top access 300.AC.20.03 incluso /Top access 300.AC.20.03 included

Note: Top access 300.AC.20.03 incluso /Top access 300.AC.20.03 included

Note:

1 Per la scelta dei contenitori e degli accessori vari, consultare il relativo listino o catalogo./To choose storage units and accessories, please check correspondent price list or catalogue;

2 Per eventuali altre composizioni e combinazioni, vedere relativo catalogo della serie./For additional compositions and combinations, please check the catalogue of the specific series;

3 Le dimensioni sono espresse in cm - consultare il listino prezzi per le caratteristiche tecniche, i codici degli articoli e delle finiture./Dimensions are stated in cm - for technical characteristics, article code numbers and finishing see price list;

# DV911 Noto

Design:  
Enzo Berti

**IT** La collezione di tavoli riunione DV911-Noto, riprende l'idea del classico tavolo da lavoro su cavalletto. La struttura è in legno massello e il piano è disponibile nelle versioni rettangolare e rotonda che conferiscono ad ogni tavolo un carattere particolare.

**EN** The DV911-Noto collection of meeting tables takes up the idea of the classic work table on trestle. The structure is in solid wood and the top is available in the rectangular and round versions that give each table a particular character.





## Tavoli/Tables

Piani di lavoro in vetro sp. 1.2 cm, con bordi perimetrali lavorati a filo lucido / Glass worktop 1.2 cm thick, with outer polished edges

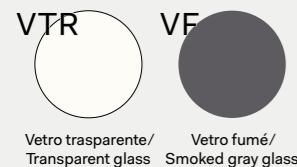

Piano di lavoro in vetro temprato trasparente sp. 0.8 cm, accoppiato con piano in gres porcellanato sp. 0.6 cm/Worktop in 0.8 cm thick transparent tempered glass, coupled with a 0.6 cm thick porcelain stoneware worktop

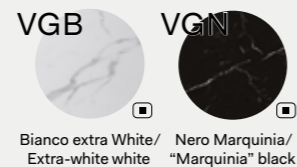

Piani di lavoro sp. 2.5 cm, in impiallacciato/Veneered worktop 2.5 cm thick

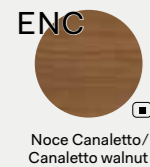

Piani di lavoro sp. 2.7 cm, in cuoio con cuciture /Worktop 2.7 cm thick, in leather with stitches



## Gambe in legno/Wooden legs



Travi in legno per piani in vetro / Wooden legs for glass worktops



Travi metalliche per piani ciechi e canalizzazione / Metallic beams for non-transparent worktops and canalization



Note

■ Prodotti non in pronta consegna. Per la disponibilità contattare l'ufficio commerciale/Items not in prompt delivery. Please contact the commercial department to check availability.

## Tavoli scrivania/riunione/Meeting-desk tables

L 240 P 120 x H 73,5  
V C



911.TV.06.24\_

L 240 - P 120 - H 75  
C



911.TR.41.24\_

L 178 P 149 x H 73,5  
V C



911.TV.28.18\_

L 178 - P 149 - H 75  
C



911.TR.21.18\_

Ø 140 x H 73,5  
V C



911.TV.28.14\_

Ø 140 - H 75  
C



911.TR.21.14\_

L 240 P 120 x H 73,9  
G C



911.TV.06.24\_

L 240 - P 120 - H 75,2  
C G



911.TR.41.24\_

L 178 P 149 x H 73,9  
G C



911.TV.28.18\_

L 178 - P 149 - H 75,2  
C G



911.TR.21.18\_

Ø 140 x H 73,9  
G C



911.TV.28.14\_

Ø 140 - H 75,2  
C G



911.TR.21.14\_

## Note:

1 Le finiture impiallacciato, gres e cuoio non sono in pronta consegna. Per la disponibilità contattare l'ufficio commerciale /Veneered, porcelain stoneware and leather finishes are not in prompt delivery. Please contact the commercial department to check availability;

2 Per la scelta dei contenitori e degli accessori vari, consultare il relativo listino o catalogo/To choose storage units and accessories, please check correspondent price list or catalogue;

3 Per eventuali altre composizioni e combinazioni, vedere relativo catalogo della serie/For additional compositions and combinations, please check the catalogue of the specific series;

4 Le dimensioni sono espresse in cm - consultare il listino prezzi per le caratteristiche tecniche, i codici degli articoli e delle finiture/Dimensions are stated in cm - for technical characteristics, article code numbers and finishing see price list;

■ Prodotti non in pronta consegna. Per la disponibilità contattare l'ufficio commerciale/Items not in prompt delivery. Please contact the commercial department to check availability;

☑ Con gambe in legno e travi in legno/Wood legs and beams

● Con gambe in legno e travi in metallo/Wood legs and metal beams

V Vetro/Glass;

C Cuoio/Leather;

G Gres/Gres;



# DV909 Tokio

Design:  
Antonio Morello

**IT** Collezione di tavoli riunione con piani in folding rivestiti in "fenix" e gambe metalliche.

**EN** Collection of meeting tables with folding tops covered in "fenix" and metal legs.

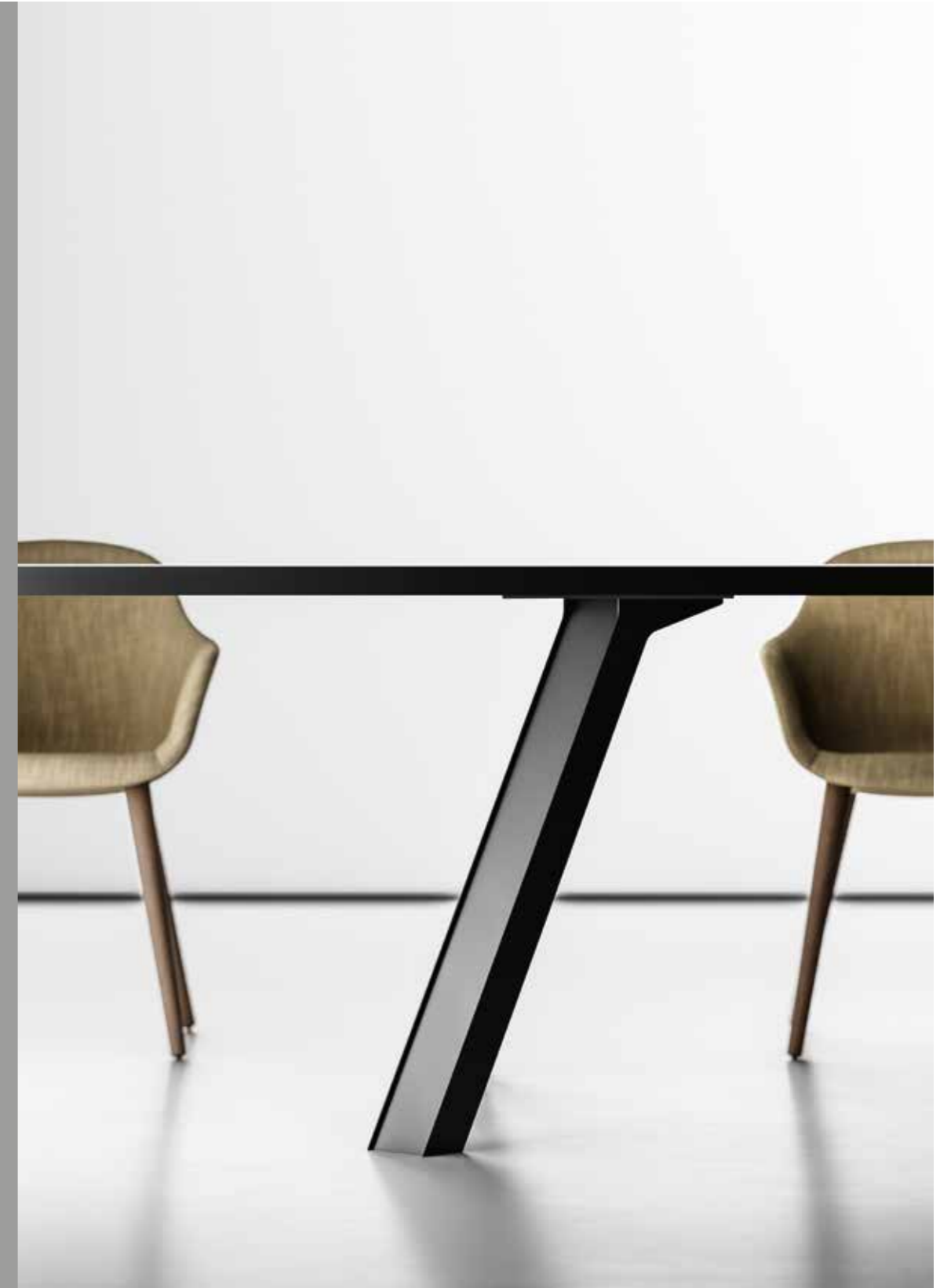





Tavoli/ Tables

Piani di lavoro sp. 3.7 cm, in folding con laminato FENIX / Folding worktops 3.7 cm thick, in FENIX laminate

Piani di lavoro sp. 4.2 cm, in listellare placcato laminato con bordi in ABS sp. 0.1 cm / Worktop 4.2 cm thick in laminate with 0.1 cm ABS edge-profiles



Strutture metalliche/Metal structures

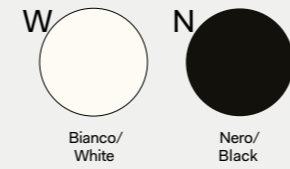

Note

▣ Prodotti non in pronta consegna. Per la disponibilità contattare l'ufficio commerciale/Items not in prompt delivery. Please contact the commercial department to check availability.

DV909 Tokio

Dati tecnici / Technical data

Tavoli riunione/Meeting tables

L 140 P 140 x H 75 ▣	L 240 P 120 x H 75 ▣	L 300 P 120 x H 75 ▣	L 360 P 120 x H 75 ▣	L 380 P 120 x H 75 ▣ ▣
909.TR.32.14_	909.TR.22.24_	909.TR.22.30_	909.TR.22.36_	909.TR.22.38_

Tavoli riunione con top access / Meeting tables with top access

L 140 P 140 x H 75 ▣	L 240 P 120 x H 75 ▣	L 300 P 120 x H 75 ▣	L 360 P 120 x H 75 ▣	L 380 P 120 x H 75 ▣ ▣
909.TR.33.14_	909.TR.23.24_	909.TR.23.30_	909.TR.23.36_	909.TR.23.38_
<small>Note: Top access 300.AC.20.03 incluso /Top access 300.AC.20.03 included</small>	<small>Note: Top access 300.AC.20.04 incluso /Top access 300.AC.20.04 included</small>	<small>Note: Top access 300.AC.20.04 incluso /Top access 300.AC.20.04 included</small>	<small>Note: Top access 300.AC.20.04 incluso /Top access 300.AC.20.04 included</small>	<small>Note: Top access 300.AC.20.04 incluso /Top access 300.AC.20.04 included</small>

Note:

1 Per la scelta dei contenitori e degli accessori vari, consultare il relativo listino o catalogo/To choose storage units and accessories, please check correspondent price list or catalogue;

2 Le dimensioni sono espresse in cm - consultare il listino prezzi per le caratteristiche tecniche, i codici degli articoli e delle finiture/Dimensions are stated in cm - for technical characteristics, article code numbers and finishing see price list;

3 Per eventuali altre composizioni e combinazioni, vedere relativo catalogo della serie/For additional compositions and combinations, please check the catalogue of the specific series;

4 Fino ad esaurimento/Until exhaustion;  
▣ Prodotti non in pronta consegna. Per la disponibilità contattare l'ufficio commerciale/Items not in prompt delivery. Please contact the commercial department to check availability;

# DV905 Rym

Design:  
Antonio Morello

IT Prestigiosi tavoli riunione dove le ampie superfici, lo stile minimal e la ricerca del dettaglio esprimono l'anima della collezione DV905.

EN Prestigious meeting tables, where wide surfaces, minimalist style and attention to detail emphasize the soul of the DV905 collection.







Tavoli/Tables

Piani di lavoro sp. 5 cm, in laminatino/Worktops 5 cm thick, in low pressure laminate

Piani di lavoro sp. 5 cm, in laminatino Fenix/Worktops 5 cm thick, in low pressure Fenix laminate

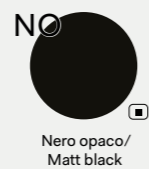

Piani di lavoro sp. 5 cm, in impiallacciato/Worktop 5 cm thick, veneered

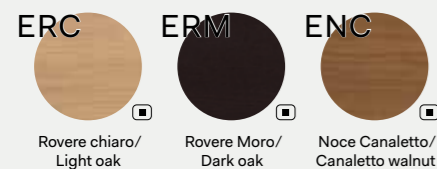

Piani di lavoro sp. 5 cm, in cuoio con cuciture/Worktop 5 cm thick, in leather with stitches



Piani di lavoro sp. 0.5 cm, in vetro retrolaccato / Worktops 0.5 cm thick, rear-lacquered glass

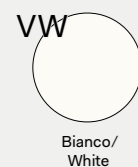

Piani di lavoro sp. 0.5 cm, in vetro temprato retrolaccato acidato con bordi perimetrali lavorati a filo lucido / Worktops 0.5 cm thick, rear-lacquered and acetated tempered glass with outer polished edges

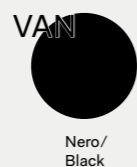

Strutture metalliche/Metal structures

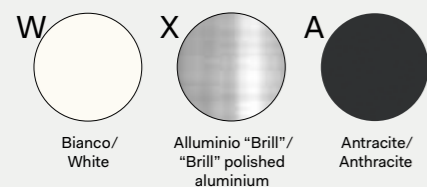

Tavoli riunione/Meeting tables

L 160 P 160 x H 75

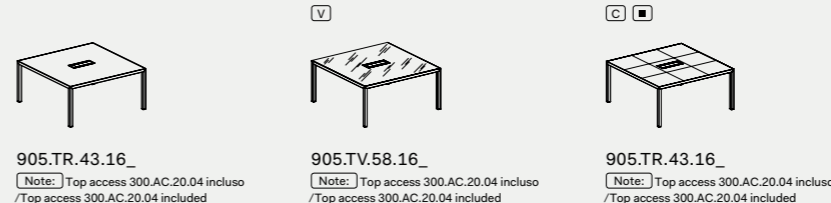

L 240 P 120 x H 75

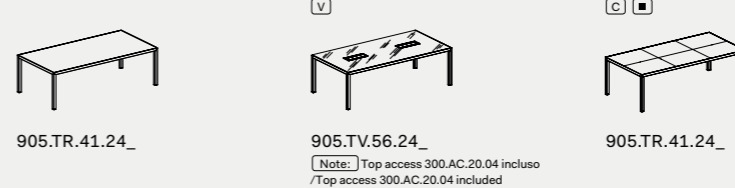

P 120 x H 75



L 300 P 120 x H 75



L 300 P 120 x H 75



L 400 P 120 x H 75



Note

■ Prodotti non in pronta consegna. Per la disponibilità contattare l'ufficio commerciale/Items not in prompt delivery. Please contact the commercial department to check availability.  
 ☒ Fino ad esaurimento/Until exhaustion.

Note:

1 Le finiture impiallacciato e cuoio non sono in pronta consegna. Per la disponibilità contattare l'ufficio commerciale /Veneered and leather finishes are not in prompt delivery. Please contact the commercial department to check availability;

2 Le dimensioni sono espresse in cm - consultare il listino prezzi per le caratteristiche tecniche, i codici degli articoli e delle finiture/Dimensions are stated in cm - for technical characteristics, article code numbers and finishing see price list;

3 Per la scelta dei contenitori e degli accessori vari, consultare il relativo listino o catalogo/To choose storage units and accessories, please check correspondent price list or catalogue;

4 Per eventuali altre composizioni e combinazioni, vedere relativo catalogo della serie/For additional compositions and combinations, please check the catalogue of the specific series;

V Vetro/Glass;  
 C Cuoio/Leather.

■ Prodotti non in pronta consegna. Per la disponibilità contattare l'ufficio commerciale/Items not in prompt delivery. Please contact the commercial department to check availability;

# DV908 Rodi

Design:  
Antonio Morello

**IT** Tavoli riunione con gambe e piani in “metallo verniciato”, sono disponibili in cinque diverse finiture e si adattano ai molteplici ambienti di lavoro.

**EN** Meeting tables with legs and worktops in “painted metal”, are available in 5 different finishes and are adaptable to multiple work environments.







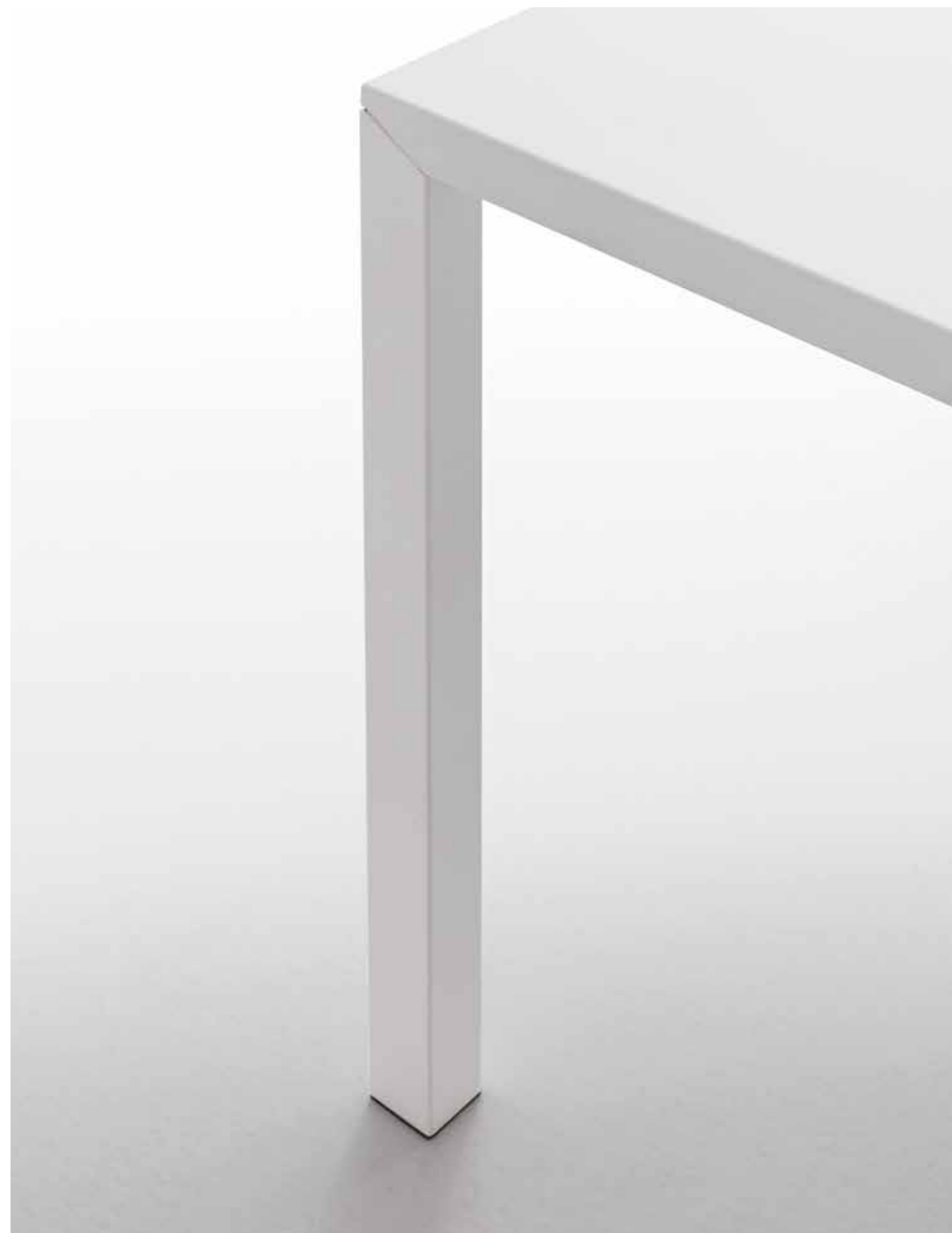

Tavoli/Tables

Piani di lavoro in metallo verniciato, sp. 4 cm / Metal painted worktops, 4 cm thick

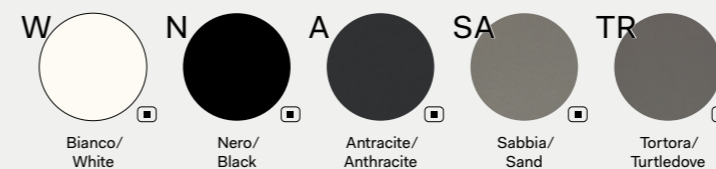

Strutture metalliche/Metal structures

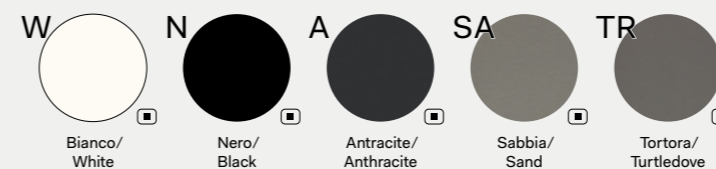

Note

Prodotti non in pronta consegna. Per la disponibilità contattare l'ufficio commerciale/Items not in prompt delivery. Please contact the commercial department to check availability.

DV908 Rodi

Dati tecnici / Technical data

Tavoli riunione/Meeting tables

L 200 P 100 x H 75

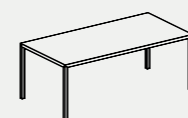

908.TR.42.20\_

L 240 P 120 x H 75

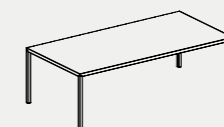

908.TR.41.24\_

L 200 P 100 x H 75

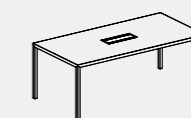

908.TR.48.20\_

Note: Top access 300.AC.20.04 incluso / Top access 300.AC.20.04 included

L 240 P 120 x H 75

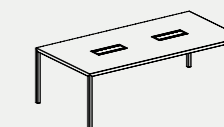

908.TR.47.24\_

Note: Top access 300.AC.20.04 incluso / Top access 300.AC.20.04 included

Note:

1 Per la scelta dei contenitori e degli accessori vari, consultare il relativo listino o catalogo/To choose storage units and accessories, please check correspondent price list or catalogue;

3 Per eventuali altre composizioni e combinazioni, vedere relativo catalogo della serie/For additional compositions and combinations, please check the catalogue of the specific series;

Prodotti non in pronta consegna. Per la disponibilità contattare l'ufficio commerciale/Items not in prompt delivery. Please contact the commercial department to check availability;

2 Le dimensioni sono espresse in cm - consultare il listino prezzi per le caratteristiche tecniche, i codici degli articoli e delle finiture/Dimensions are stated in cm - for technical characteristics, article code numbers and finishing see price list;

# DV903 Tay

Design:  
Perin&Topan

**IT** La ricchezza e la preziosità delle finiture dei tavoli riunione di questa serie DV903 generano una perfetta sintesi fra funzione e design, eleganza e tecnologia.

**EN** The richness and preciousness of the finishes of the DV903 series meeting table, create a perfect synthesis of function and design, elegance and technology.







Tavoli/ Tables

Piani di lavoro sp. 1 cm, in vetro temprato retrolaccato con bordi perimetrali lavorati a filo lucido/Worktops 1 cm thick, rear-lacquered tempered glass with outer polished edges

Piani di lavoro sp. 1 cm, in vetro temprato retrolaccato acidato con bordi perimetrali lavorati a filo lucido/Worktops 1 cm thick, rear-lacquered and acetated tempered glass with outer polished edges

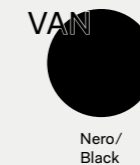
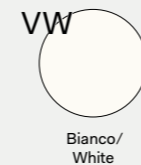

Piani di lavoro sp. 1.2 cm, in vetro fumé temprato con bordi perimetrali lavorati a filo lucido/Worktops 1.2 cm thick, smoked grey tempered glass with outer polished edges

Piano di lavoro in vetro temprato trasparente sp. 0.8 cm, accoppiato con piano in gres porcellanato sp. 0.6 cm/Worktop in 0.8 cm thick transparent tempered glass, coupled with a 0.6 cm thick porcelain stoneware worktop

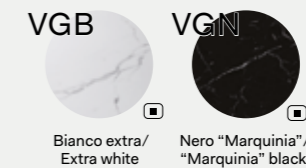

Gambe metalliche / Metal legs

Gambone in metallo con base/Metal column base

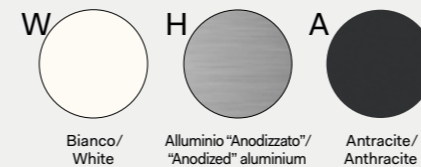

Note

Prodotti non in pronta consegna. Per la disponibilità contattare l'ufficio commerciale/Items not in prompt delivery. Please contact the commercial department to check availability.

Tavoli riunione in vetro/Glass meeting tables

Tavoli riunione in gres/Gres meeting tables

Ø 100 x H 75  
V



903.TV.14.10\_ [E] [HA]  
903.TV.15.10\_ [H]

P 160 x H 75  
V [E]

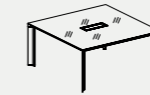

903.TV.38.16\_ L 160  
[Note:] Top access 300.AC.20.04 incluso /Top access 300.AC.20.04 included

P 120 x H 75  
V [E]

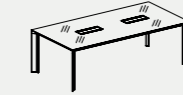

903.TV.56.24\_ L 240  
[Note:] Top access 300.AC.20.04 incluso /Top access 300.AC.20.04 included

ø 100 x H 75  
G [E]



903.TV.14.10\_ [E] [HA]  
903.TV.15.10\_ [H]

P 140 x H 75  
G [E]



903.TV.38.14\_ L 140  
[Note:] Top access 300.AC.20.04 incluso /Top access 300.AC.20.04 included

P 120 x H 75  
G [E]



903.TV.56.24\_ L 240  
[Note:] Top access 300.AC.20.04 incluso /Top access 300.AC.20.04 included

Note:

1 Le finiture in gres non sono in pronta consegna. Per la disponibilità contattare l'ufficio commerciale /Gres finishes are not in prompt delivery. Please contact the commercial department to check availability;

2 Per la scelta dei contenitori e degli accessori vari, consultare il relativo listino o catalogo/To choose storage units and accessories, please check correspondent price list or catalogue;

3 Per eventuali altre composizioni e combinazioni, vedere relativo catalogo della serie/For additional compositions and combinations, please check the catalogue of the specific series;

4 Le dimensioni sono espresse in cm – consultare il listino prezzi per le caratteristiche tecniche, i codici degli articoli e delle finiture/Dimensions are stated in cm – for technical characteristics, article code numbers and finishing see price list;

Prodotti non in pronta consegna. Per la disponibilità contattare l'ufficio commerciale/Items not in prompt delivery. Please contact the commercial department to check availability;

Per eventuali giacenze a magazzino delle precedenti versioni senza top-access, contattare l'ufficio commerciale/To check stock availabilities of table tops without top-access, please contact our commercial department;

Fino ad esaurimento/Until exhaustion;

V Vetro/Glass; G Gres/Gres;

HA Gambone in alluminio anodizzato / Metal column made in "Anodized" aluminium;

H Gambone verniciato a polveri in bianco, alluminio o antracite / Metal column electrostatic painted in white, aluminum or anthracite;

# DV901 Vertigo

Design:  
Antonio Morello

**IT** Eleganza nel design e ricercatezza nei dettagli: i tratti distintivi di questa collezione DV901. Caratterizzanti sono i tavoli riunione per la tecnica della loro struttura realizzata con profili e gambe in estrusi di alluminio collegati mediante particolari giunti cromati.

**EN** Elegant design and attention to detail are the distinctive features of DV901 collection. What stands out in the meeting tables is the technical nature of the structure, composed of extruded aluminium profiles and legs, connected with special chromed joints.













Tavoli/Tables

Piani di lavoro sp. 1.8 cm, in melaminico (\*) o laminato (\*\*\*) con bordi in ABS sp. 0.2 cm / Worktops 1.8 cm thick, in melamine (\*) or laminate (\*\*\*) with ABS edge-profiles 0.2 cm thick

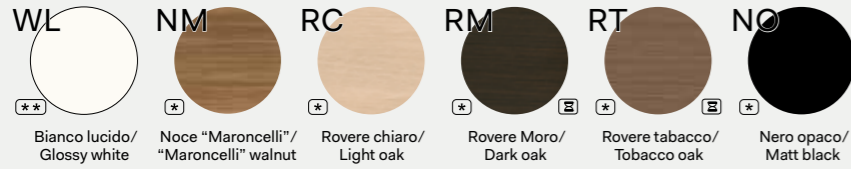

Piani di lavoro sp. 1.8 cm, in impiallacciato / Worktop 1.8 cm thick, veneered

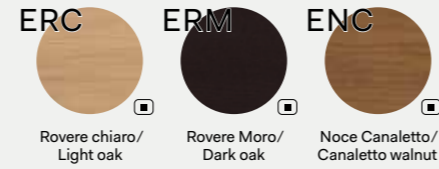

Piani di lavoro sp. 2 cm, in cuoio con cuciture / Worktop 2 cm thick, in leather with stitches



Piani di lavoro sp. 1 cm, in vetro temprato retrolaccato con bordi perimetrali lavorati a filo lucido / Worktops 1 cm thick, rear-lacquered tempered glass with outer polished edges

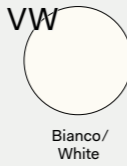

Piani di lavoro sp. 1 cm, in vetro temprato retrolaccato acidato con bordi perimetrali lavorati a filo lucido / Worktops 1 cm thick, rear-lacquered and acetated tempered glass with outer polished edges

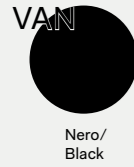

Piano di lavoro in vetro temprato trasparente sp. 0.8 cm, accoppiato con piano in gres porcellanato sp. 0.6 cm / Worktop in 0.8 cm thick transparent tempered glass, coupled with 0.6 cm thick porcelain stoneware worktop



Strutture metalliche/Metal structures

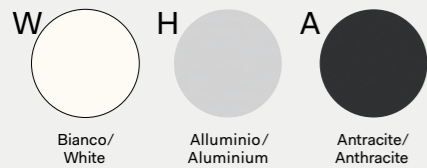

Gambone in metallo con base/Metal column base



Note  
 □ Prodotti non in pronta consegna. Per la disponibilità contattare l'ufficio commerciale/Items not in prompt delivery. Please contact the commercial department to check availability.  
 ⊞ Fino ad esaurimento/Until exhaustion.

Tavoli riunione/Meeting tables

Ø 100 x H 74,5    Ø 100 x H 75    L 100 P 100 x H 75    L 100 P 100 x H 74,5    L 100 P 100 x H 75    L 160 P 160 x H 75    L 160 P 160 x H 74,5    L 160 P 160 x H 75

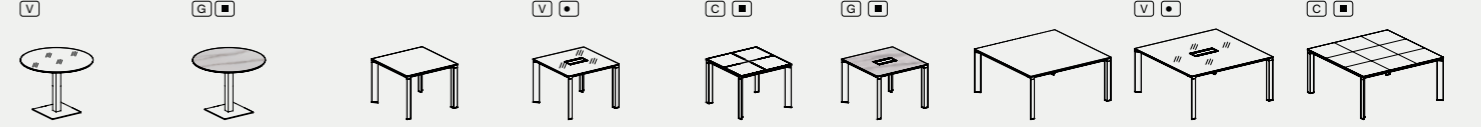

901.TV.14.10\_ ⊞ HA    901.TV.14.10\_ ⊞ HA    901.TR.42.10\_    901.TV.77.10\_    901.TR.42.10\_    901.TV.77.10\_    901.TR.43.16\_    901.TV.38.16\_    901.TR.43.16\_  
 901.TV.15.10\_ ⊞ H    901.TV.15.10\_ ⊞ H

L 140 P 140 x H 75,5    L 160 P 160 x H 75    L 240 P 120 x H 75    L 240 P 120 x H 74,5    L 240 P 120 x H 75    L 240 P 120 x H 75,5

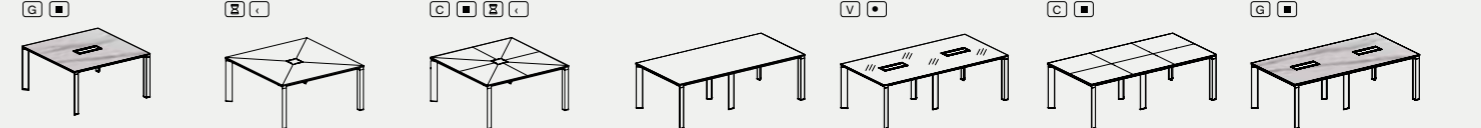

901.TV.38.14\_    901.TR.51.16\_    901.TR.51.16\_    901.TR.41.24\_    901.TV.36.24\_    901.TR.41.24\_    901.TV.36.24\_

Tavoli riunione componibili con gambe centrali rientrate/Modular meeting tables with central recessed legs

L 320 P 80 x H 75    P 90 x H 75    L 320 P 160 x H 75



901.TR.55.32\_    901.TR.55.32\_    901.TR.55.36\_ L 360    901.TR.55.36\_ L 360    901.TR.32.32\_    901.TR.55.40\_ L 400    901.TR.55.40\_ L 400

L 320 P 160 x H 75    L 480 P 160 x H 75

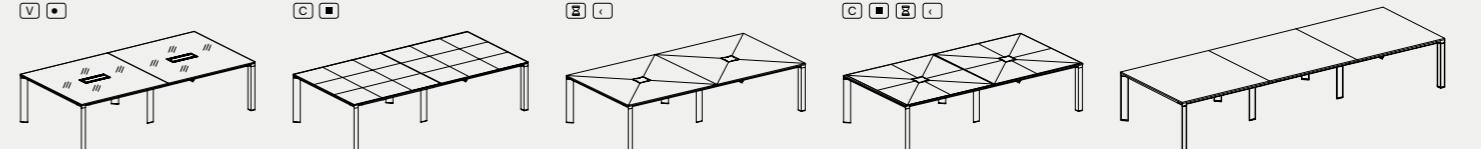

901.TV.47.32\_    901.TR.32.32\_    901.TR.52.32\_    901.TR.52.32\_    901.TR.32.48\_

L 480 P 160 x H 75

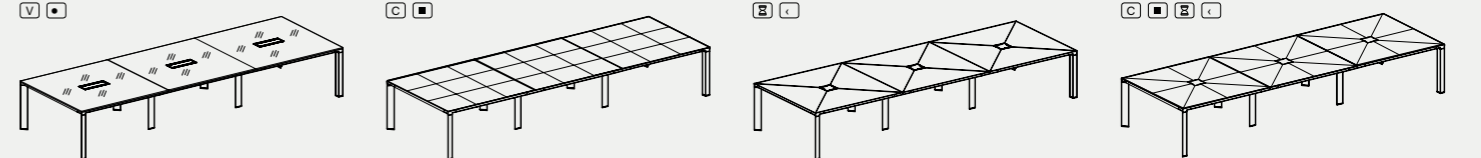

901.TV.47.48\_    901.TR.32.48\_    901.TR.52.48\_    901.TR.52.48\_

Elementi per tavoli riunione componibili con gambe centrali rientrate/Modular elements for compound meeting tables with central recessed legs

L 160 P 80 x H 75    P 90 x H 75

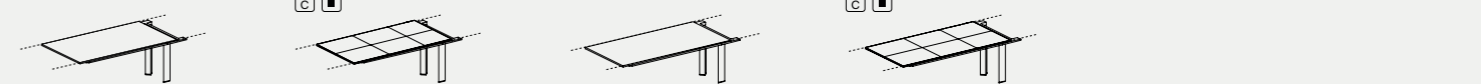

901.TR.55.16\_    901.TR.55.16\_    901.TR.55.18\_ L 180    901.TR.55.18\_ L 180    901.TR.55.20\_ L 200    901.TR.55.20\_ L 200

L 160 P 160 x H 75    L 160 P 160 x H 74,5



901.TR.32.16\_    901.TR.32.16\_    901.TR.52.16\_    901.TR.52.16\_    901.TV.47.16\_

Note:  
 1 Le finiture impiallacciato, gres e cuoio non sono in pronta consegna. Per la disponibilità contattare l'ufficio commerciale /Veneered, porcelain stoneware and leather finishes are not in prompt delivery. Please contact the commercial department to check availability;  
 2 Per la scelta dei contenitori e degli accessori vari, consultare il relativo listino o catalogo/To choose storage units and accessories, please check correspondent price list or catalogue;  
 3 Per eventuali altre composizioni e combinazioni, vedere relativo catalogo della serie/For additional compositions and combinations, please check the catalogue of the specific series;  
 4 Le dimensioni sono espresse in cm - consultare il listino prezzi per le caratteristiche tecniche, i codici degli articoli e delle finiture/Dimensions are stated in cm - for technical characteristics, article code numbers and finishing see price list;  
 □ Prodotti non in pronta consegna. Per la disponibilità contattare l'ufficio commerciale/Items not in prompt delivery. Please contact the commercial department to check availability;  
 ⊞ Per eventuali giacenze a magazzino delle precedenti versioni senza top-access, contattare l'ufficio commerciale /To check stock availabilities of table tops without top-access, please contact our commercial department;

⊞ Vetro/Glass;    ⊞ Gres/Gres;  
 ⊞ Cuoio/Leather;    ⊞ Tavoli scrivania con piani composti /Desks with compound worktops.  
 ⊞ Fino ad esaurimento/Until exhaustion;  
 ⊞ Gambone in alluminio anodizzato / Metal column made in "Anodized" aluminium;  
 ⊞ Gambone verniciato a polveri in bianco, alluminio o antracite / Metal column electrostatic painted in white, aluminum or anthracite;

# DV910 Oxford

Design:  
Antonio Morello

**IT** Nuova serie di tavoli riunione direzionali DV910 dal disegno tradizionale, adattabili ad ogni ambiente di lavoro grazie alla sintesi progettuale degli elementi costruttivi.

**EN** New series of DV910 executive meeting tables with a traditional design, with its traditional look is adaptable to any work environment thanks to design of its constructional elements.







Tavoli/ Tables

Piani di lavoro sp. 3.8 cm, in melaminico con bordi in ABS sp. 0.2 cm  
/Worktops 3.8 cm thick, in melamine with ABS edge-profiles 0.2 cm thick

Piano di lavoro effetto pelle sp. 3.8 cm  
/Leather effect worktop 3.8 cm thick



Piano frontale dei piani composti sp. 3.8 cm  
/Melamine panelled legs and frame 3.8 cm thick



Note

- Prodotti non in pronta consegna. Per la disponibilità contattare l'ufficio commerciale/Items not in prompt delivery. Please contact the commercial department to check availability.
- ⊠ Fino ad esaurimento/Until exhaustion.

DV910 Oxford

Dati tecnici / Technical data

Tavoli riunione/ Meeting tables

L 140 P 140 x H 75

L 240 P 120 x H 75

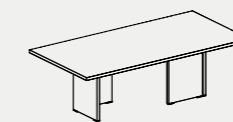
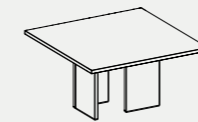

910.TR.38.14\_

910.TR.41.24\_

Note:

- ① Le finiture in effetto pelle non sono in pronta consegna. Per la disponibilità contattare l'ufficio commerciale /Leather effect finish are not in prompt delivery. Please contact the commercial department to check availability;
- ② Per la scelta dei contenitori e degli accessori vari, consultare il relativo listino o catalogo/To choose storage units and accessories, please check correspondent price list or catalogue;

- ③ Per eventuali altre composizioni e combinazioni, vedere relativo catalogo della serie/For additional compositions and combinations, please check the catalogue of the specific series;

- ④ Le dimensioni sono espresse in cm - consultare il listino prezzi per le caratteristiche tecniche, i codici degli articoli e delle finiture/Dimensions are stated in cm - for technical characteristics, article code numbers and finishing see price list;

# Workstations Tables

# DV804 E-Place

Design:  
Perin & Topan

**IT** Collezione DV804 dispone di tavoli riunioni versatili, funzionali e con una grande facilità d'installazione. Si caratterizza per i suoi originali tavoli con struttura su "gambe a cavalletto".

**EN** The DV804 meeting tables are versatile, functional and easy to install. The trestle legs, on which the tables' structure lay on, are the characterizing element of the series.









Tavoli/ Tables

Piani di lavoro sp. 2.5 cm, in melaminico con bordi perimetrali in ABS sp. 0.2 cm / Worktops 2.5 cm thick, in melamine with 0.2 cm ABS edge-profiles

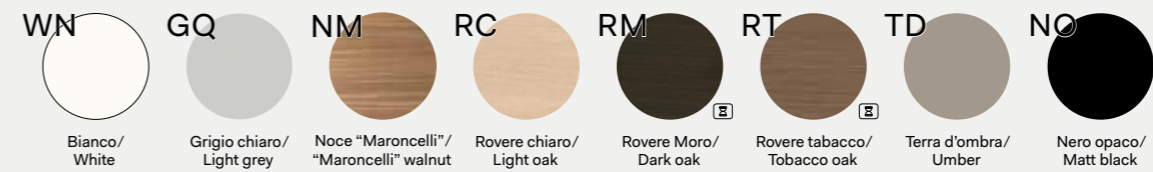

Strutture metalliche/Metal structures



Note

- Prodotti non in pronta consegna. Per la disponibilità contattare l'ufficio commerciale/Items not in prompt delivery. Please contact the commercial department to check availability.
- Ⓢ Fino ad esaurimento/Until exhaustion.

DV804 E-Place

Dati tecnici / Technical data

Piani di lavoro in melaminico sp. 25 mm con bordi perimetrali in ABS sp. 2 mm / Worktops in melamine 1" thick with perimetrical edges in ABS 2/32" thick

Tavoli riunione/Meeting tables

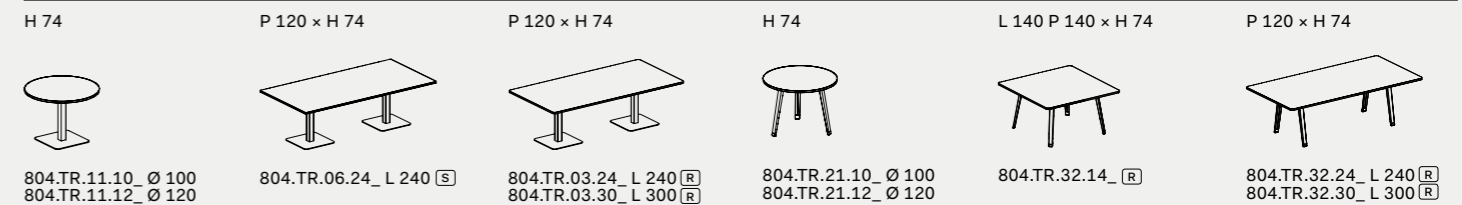

Tavoli P 158 a 2 scrivanie contrapposte + binario centrale con 2 sportelli/Benches 158 depth + central rail with 2 flip-up covers

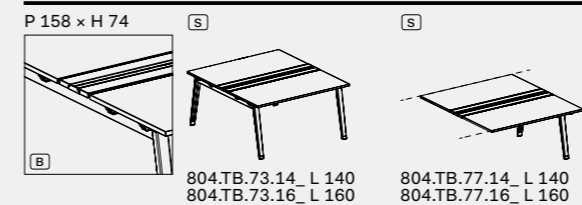

Raccordi/Connection elements

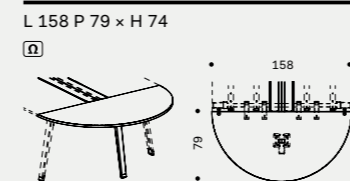

Piani terminali/Terminal tops

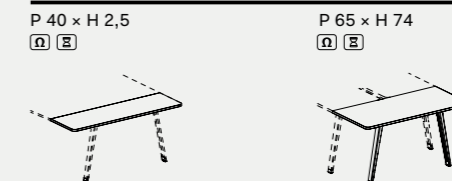

Note:

- ① Le dimensioni sono espresse in cm - consultare il listino prezzi per le caratteristiche tecniche, i codici degli articoli e delle finiture/Dimensions are stated in cm - for technical characteristics, article code numbers and finishing see price list;
- ② Per la scelta dei contenitori e degli accessori vari, consultare il relativo listino o catalogo/To choose storage units and accessories, please check correspondent price list or catalogue;
- ③ Per eventuali altre composizioni e combinazioni, vedere relativo catalogo della serie/For additional compositions and combinations, please check the catalogue of the specific series;
- Ⓜ Con piani con angoli raggiati/With tops with rounded corners;
- Ⓢ Con piani con angoli a spigolo/With tops with sharp corners;
- Ⓢ Da utilizzare solo con tavoli indipendenti /To be used with single desks
- Ⓜ Con binario centrale/With central rail;
- Ⓢ Fino ad esaurimento/Until exhaustion;

# DV801 Entity

Design:  
Antonio Morello

**IT** Linea operativa DV801 che si distingue per la sua particolare essenzialità e semplicità. I suoi tavoli riunione si prestano a svariati ambienti lavorativi.

**EN** The DV801 operative series stands out for its particular essentiality and simplicity. Its meeting tables are suitable to various work environments.





Tavoli/Tables

Piani di lavoro sp. 1.8 cm, in melaminico con bordi in ABS sp. 0.2 cm/Worktops 1.8 cm thick, in melamine with ABS edge-profiles 0.2 cm thick



Strutture metalliche/Metal structures



Piani di lavoro in melaminico sp. 18 mm con bordi perimetrali in ABS/Worktops in melamine 23/32" thick with perimetrical edges in ABS

Tavolo riunioni/Conference tables

P 120 x H 74

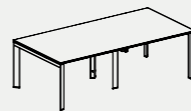

801.TR.40.24\_ L 240

Tavoli scrivania P 136,5/Desks 136,5 depth

P 136,5 x H 74

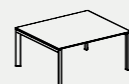
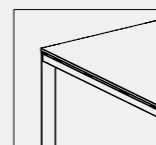

801.TS.37.14\_ L 140  
801.TS.37.16\_ L 160  
801.TS.37.18\_ L 180

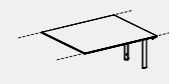

801.TS.38.14\_ L 140  
801.TS.38.16\_ L 160  
801.TS.38.18\_ L 180

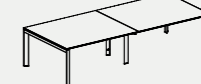

801.TS.37.28\_ L 280  
801.TS.37.32\_ L 320  
801.TS.37.36\_ L 360

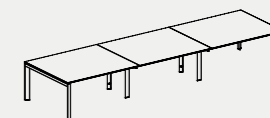

801.TS.37.42\_ L 420  
801.TS.37.48\_ L 480  
801.TS.37.54\_ L 540

Tavoli scrivania doppia P 158 con asole e 2 top access/Benches 158 depth with opening and 2 top access

P 158 x H 74

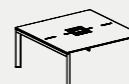
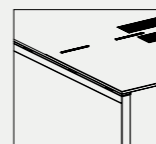

801.TB.25.14\_ L 140  
801.TB.25.16\_ L 160  
801.TB.25.18\_ L 180

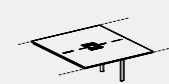

801.TB.29.14\_ L 140  
801.TB.29.16\_ L 160  
801.TB.29.18\_ L 180



801.FB.25.28\_ L 280  
801.FB.25.32\_ L 320  
801.FB.25.36\_ L 360

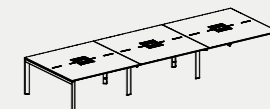

801.SB.25.42\_ L 420  
801.SB.25.48\_ L 480  
801.SB.25.54\_ L 540

Tavoli P 158 a 2 scrivanie contrapposte + binario centrale con 2 sportelli/Benches 158 depth + central rail with 2 flip-up covers

P 158 x H 74

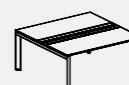
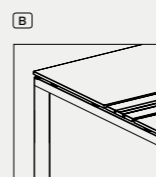

801.TB.23.08\_ L 80  
801.TB.23.10\_ L 100  
801.TB.23.12\_ L 120  
801.TB.23.14\_ L 140  
801.TB.23.16\_ L 160  
801.TB.23.18\_ L 180  
801.TB.23.20\_ L 200

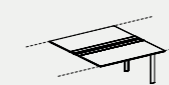

801.TB.27.08\_ L 80  
801.TB.27.10\_ L 100  
801.TB.27.12\_ L 120  
801.TB.27.14\_ L 140  
801.TB.27.16\_ L 160  
801.TB.27.18\_ L 180  
801.TB.27.20\_ L 200

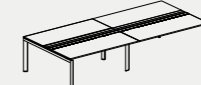

801.FB.23.16\_ L 160  
801.FB.23.20\_ L 200  
801.FB.23.24\_ L 240  
801.FB.23.28\_ L 280  
801.FB.23.32\_ L 320  
801.FB.23.36\_ L 360  
801.FB.23.40\_ L 400

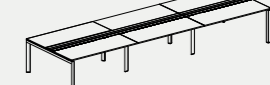

801.SB.23.24\_ L 240  
801.SB.23.30\_ L 300  
801.SB.23.36\_ L 360  
801.SB.23.42\_ L 420  
801.SB.23.48\_ L 480  
801.SB.23.54\_ L 540  
801.SB.23.60\_ L 600

Piani terminali/Terminal tops

P 40 x H 1,8

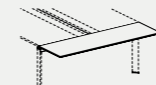

801.PT.01.13\_ L 136,5  
801.PT.01.15\_ L 158

P 65 x H 74

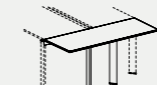

801.PT.02.13\_ L 136,5  
801.PT.02.15\_ L 158

Note

■ Prodotti non in pronta consegna. Per la disponibilità contattare l'ufficio commerciale/Items not in prompt delivery. Please contact the commercial department to check availability.  
 ■ Fino ad esaurimento/Until exhaustion.

Note:

① Le dimensioni sono espresse in cm - consultare il listino prezzi per le caratteristiche tecniche, i codici degli articoli e delle finiture/Dimensions are stated in cm - for technical characteristics, article code numbers and finishing see price list;

② Per la scelta dei contenitori e degli accessori vari, consultare il relativo listino o catalogo/To choose storage units and accessories, please check correspondent price list or catalogue;

③ Per eventuali altre composizioni e combinazioni, vedere relativo catalogo della serie/For additional compositions and combinations, please check the catalogue of the specific series;

■ Prodotti non in pronta consegna. Per la disponibilità contattare l'ufficio commerciale/Items not in prompt delivery. Please contact the commercial department to check availability;

■ Con binario centrale/With central rail;

# DV802

Design:  
Antonio Morello

**IT** Linee pulite e geometrie semplici, sono il filo conduttore di questa collezione DV802. È possibile organizzare gli spazi operativi e di meeting grazie ai suoi raffinati tavoli riunione.

**EN** Clean lines and simple geometries are the leitmotif of the DV802 series. Its sophisticated meeting tables allow organizing work and meeting areas.





## Tavoli/Tables

Piani di lavoro sp. 1.8 cm, in melaminico con bordi in ABS sp. 0.2 cm/Worktops 1.8 cm thick, in melamine with ABS edge-profiles 0.2 cm thick



## Strutture metalliche/Metal structures



## Note

■ Prodotti non in pronta consegna. Per la disponibilità contattare l'ufficio commerciale/Items not in prompt delivery. Please contact the commercial department to check availability.  
 ☒ Fino ad esaurimento/Until exhaustion.

Piani di lavoro in melaminico sp. 18 mm con bordi perimetrali in ABS/Worktops in melamine 23/32" thick with perimetrical edges in ABS

## Tavolo riunioni/Conference tables

P 120 x H 74

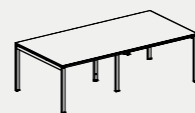

802.TR.40.24\_L 240

## Tavoli scrivania P 136,5/Desks 136,5 depth

P 136,5 x H 74

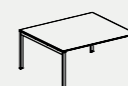
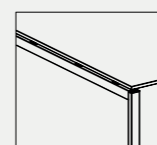

802.TS.37.14\_L 140  
802.TS.37.16\_L 160  
802.TS.37.18\_L 180

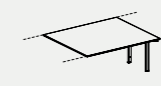

802.TS.38.14\_L 140  
802.TS.38.16\_L 160  
802.TS.38.18\_L 180

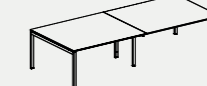

802.TS.37.28\_L 280  
802.TS.37.32\_L 320  
802.TS.37.36\_L 360

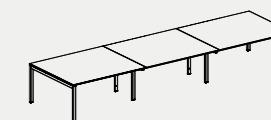

802.TS.37.42\_L 420  
802.TS.37.48\_L 480  
802.TS.37.54\_L 540

## Tavoli scrivania doppia P 158 con asole e 2 top access/Benches 158 depth with opening and 2 top access

P 158 x H 74

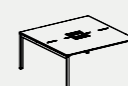
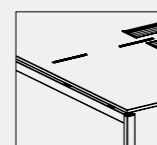

802.TB.25.14\_L 140  
802.TB.25.16\_L 160  
802.TB.25.18\_L 180

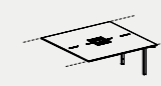

802.TB.29.14\_L 140  
802.TB.29.16\_L 160  
802.TB.29.18\_L 180

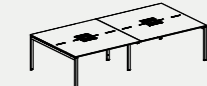

802.FB.25.28\_L 280  
802.FB.25.32\_L 320  
802.FB.25.36\_L 360

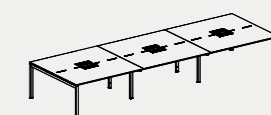

802.SB.25.42\_L 420  
802.SB.25.48\_L 480  
802.SB.25.54\_L 540

## Tavoli P 158 a 2 scrivanie contrapposte + binario centrale con 2 sportelli/Benches 158 depth + central rail with 2 flip-up covers

P 158 x H 74

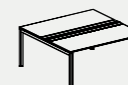
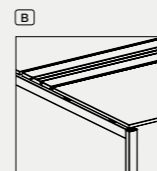

802.TB.23.08\_L 80  
802.TB.23.10\_L 100  
802.TB.23.12\_L 120  
802.TB.23.14\_L 140  
802.TB.23.16\_L 160  
802.TB.23.18\_L 180  
802.TB.23.20\_L 200

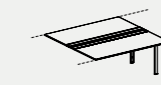

802.TB.27.08\_L 80  
802.TB.27.10\_L 100  
802.TB.27.12\_L 120  
802.TB.27.14\_L 140  
802.TB.27.16\_L 160  
802.TB.27.18\_L 180  
802.TB.27.20\_L 200

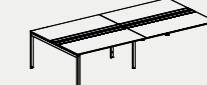

802.FB.23.16\_L 160  
802.FB.23.20\_L 200  
802.FB.23.24\_L 240  
802.FB.23.28\_L 280  
802.FB.23.32\_L 320  
802.FB.23.36\_L 360  
802.FB.23.40\_L 400

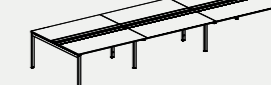

802.SB.23.24\_L 240  
802.SB.23.30\_L 300  
802.SB.23.36\_L 360  
802.SB.23.42\_L 420  
802.SB.23.48\_L 480  
802.SB.23.54\_L 540  
802.SB.23.60\_L 600

## Piani terminali/Terminal tops

P 40 x H 1,8

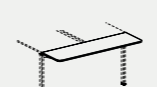

802.PT.01.13\_L 136,5  
802.PT.01.15\_L 158

P 65 x H 74

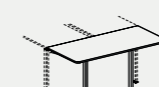

802.PT.02.13\_L 136,5  
802.PT.02.15\_L 158

## Note:

① Le dimensioni sono espresse in cm - consultare il listino prezzi per le caratteristiche tecniche, i codici degli articoli e delle finiture/Dimensions are stated in cm - for technical characteristics, article code numbers and finishing see price list;

② Per la scelta dei contenitori e degli accessori vari, consultare il relativo listino o catalogo/To choose storage units and accessories, please check correspondent price list or catalogue;

③ Per eventuali altre composizioni e combinazioni, vedere relativo catalogo della serie/For additional compositions and combinations, please check the catalogue of the specific series;

■ Prodotti non in pronta consegna. Per la disponibilità contattare l'ufficio commerciale/Items not in prompt delivery. Please contact the commercial department to check availability;

☒ Con binario centrale/With central rail;



# DV803 Nobu

Design:  
Perin & Topan

**IT** Collezione operativa DV803 con tavoli riunione che danno ampio spazio allo scambio d'idee. L'attenta scelta dei materiali impreziosisce gli ambienti di "Meeting".

**EN** DV803 operative series includes meeting tables that give ample space to exchange of ideas. The careful choice of the materials helps to give a very precious feeling to a meeting environment.







## Tavoli/Tables

Piani di lavoro sp. 2.5 cm, in melaminico con bordi perimetrali in ABS sp. 0.2 cm/Worktops 2.5 cm thick, in melamine with 0.2 cm ABS edge-profiles



## Strutture metalliche/Metal structures



## Note

▣ Prodotti non in pronta consegna. Per la disponibilità contattare l'ufficio commerciale/Items not in prompt delivery. Please contact the commercial department to check availability.  
 ☒ Fino ad esaurimento/Until exhaustion.

Piani di lavoro in melaminico sp. 25 mm con bordi perimetrali in ABS/Worktops in melamine 1" thick with perimetrical edges in ABS

Tavoli scrivania altezza fissa H 74 (tipo C)/Fix desks height, H 74 cm (type C)

## Tavoli riunione/Conference tables

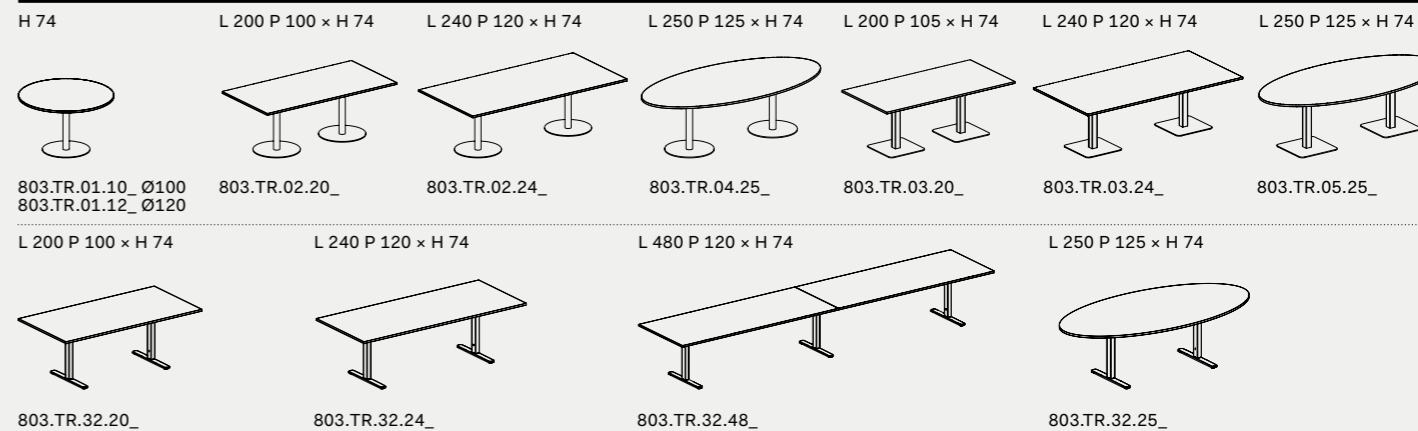

## Raccordi/Connection elements

L 100 P 50 x H 74

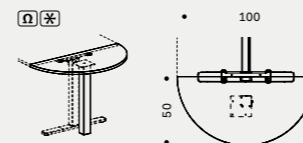

803.PT.11.10\_

Tavoli scrivania posizionabili in altezza con pulsante da 65÷86 cm (tipo B-D) / Desks with adjustable height by push-button, from 65÷86 cm (type B-D)

## Tavoli riunione/Conference tables

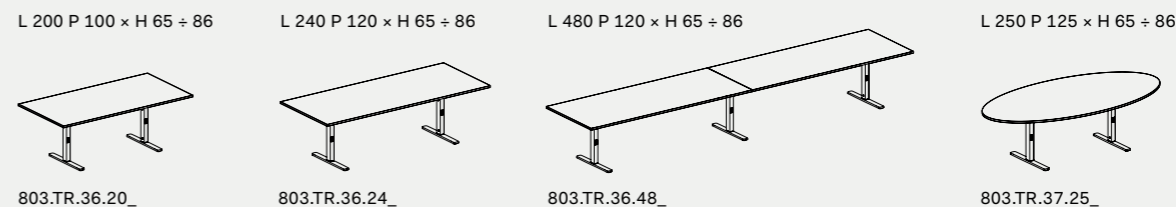

## Note:

① Le dimensioni sono espresse in cm - consultare il listino prezzi per le caratteristiche tecniche, i codici degli articoli e delle finiture/Dimensions are stated in cm - for technical characteristics, article code numbers and finishing see price list;

② Per la scelta dei contenitori e degli accessori vari, consultare il relativo listino o catalogo/To choose storage units and accessories, please check correspondent price list or catalogue;

③ Per eventuali altre composizioni e combinazioni, vedere relativo catalogo della serie/For additional compositions and combinations, please check the catalogue of the specific series;

☒ Non utilizzabili su tavoli regolabili /Can not be used on adjustable tables.

▣ Da utilizzare solo con tavoli indipendenti /To be used with single desks;

# DV805 Treko

Design:  
Antonio Morello

**IT** Serie di tavoli riunione operativi DV805 con prospettive da manuale, che mettono in evidenza la tradizionale “pannellatura” rivista in chiave moderna.

**EN** A modern twist is given to the traditional “panelled leg” look of the DV805 operative series meeting tables.







Tavoli / Tables

Piani di lavoro, gambe pannellate sp. 2.5 cm con bordi in ABS sp. 0.2 cm e modesty panels sp. 1.8 cm, in melaminico con bordo ABS colore bianco / Worktops and panelled legs 2.5 cm thick with 0.2 cm thick ABS edgebanding, modesty panels 1.8 cm thick, in melamine with white ABS edge banding



Strutture metalliche/Metal structures

Gamboni - Colonne in metallo/Metal columns

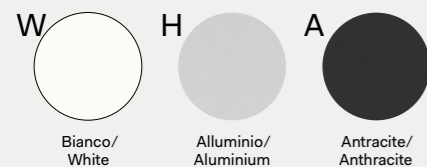

Piedini livellatori e distanziali in ABS/Adjustable feet and ABS spacers

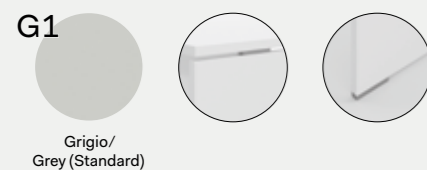

Piani di lavoro in melaminico sp. 25 mm con bordi perimetrali in ABS/Worktops in melamine 25 mm thick with perimetrical edges in ABS

Tavoli riunione/Conference tables

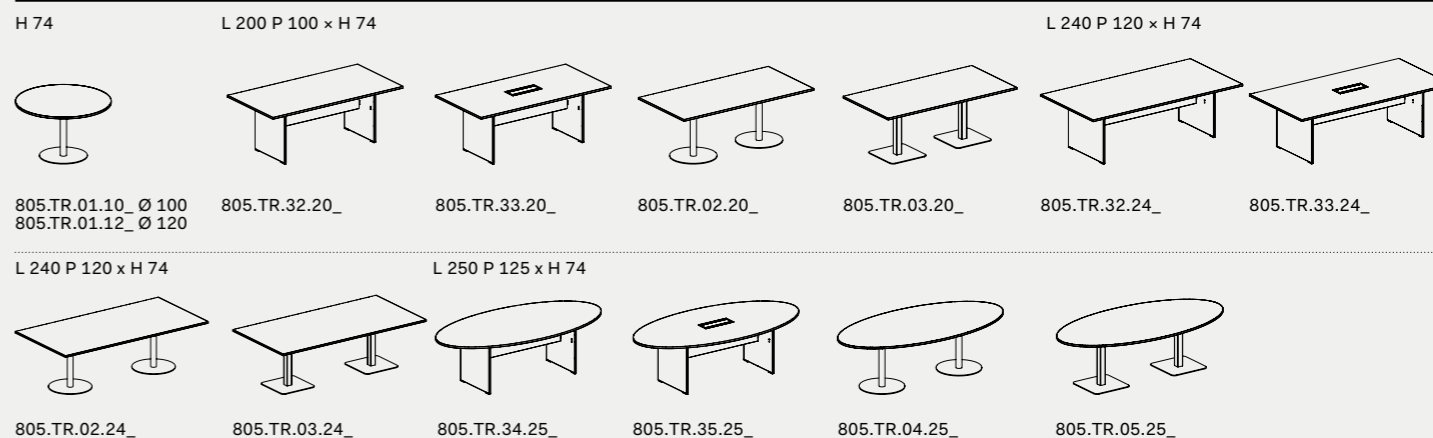

Raccordi/Connection elements

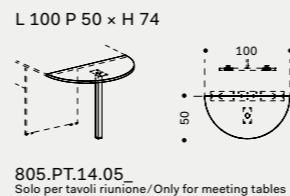

Note

❑ Prodotti non in pronta consegna. Per la disponibilità contattare l'ufficio commerciale/Items not in prompt delivery. Please contact the commercial department to check availability.  
 ❑ Fino ad esaurimento/Until exhaustion.

Note:

❶ Le dimensioni sono espresse in cm - consultare il listino prezzi per le caratteristiche tecniche, i codici degli articoli e delle finiture/Dimensions are stated in cm - for technical characteristics, article code numbers and finishing see price list;  
 ❷ Per la scelta dei contenitori e degli accessori vari, consultare il relativo listino o catalogo/To choose storage units and accessories, please check correspondent price list or catalogue;  
 ❸ Per eventuali altre composizioni e combinazioni, vedere relativo catalogo della serie/For additional compositions and combinations, please check the catalogue of the specific series;



# DV812 Enna

Design:  
Antonio Morello

**IT** Le eleganti e minimali gambe freestanding, si abbinano a piani di lavoro dalle forme e dimensioni più diverse, così da poter creare configurazioni funzionali e personalizzate.

**EN** Functional and customized configurations both for individual and collective work environments can be created via the combination of elegant and minimal freestanding legs.





Tavoli/Tables

Piani di lavoro sp. 3.8 cm, in melaminico con bordi in ABS sp. 0.2 cm /  
Worktops 3.8 cm thick, in melamine with ABS edge-profiles 0.2 cm thick

Piano di lavoro effetto pelle sp. 3.8 cm (per tavoli riunione - esclusi tavoli riunione rotondi) /  
Leather effect worktop 3.8 cm thick (for meeting tables - round meeting tables are not included)



Gambe metalliche/Metal legs



Carter chiuso e aperto / Casing closed and open



Note

Prodotti non in pronta consegna. Per la disponibilità contattare l'ufficio commerciale/Items not in prompt delivery. Please contact the commercial department to check availability.

Piani di lavoro in melaminico sp. 38 mm con bordi perimetrali in ABS/Worktops in melamine 1 1/2" thick with perimetrical edges in ABS

Tavolo riunioni/Conference tables

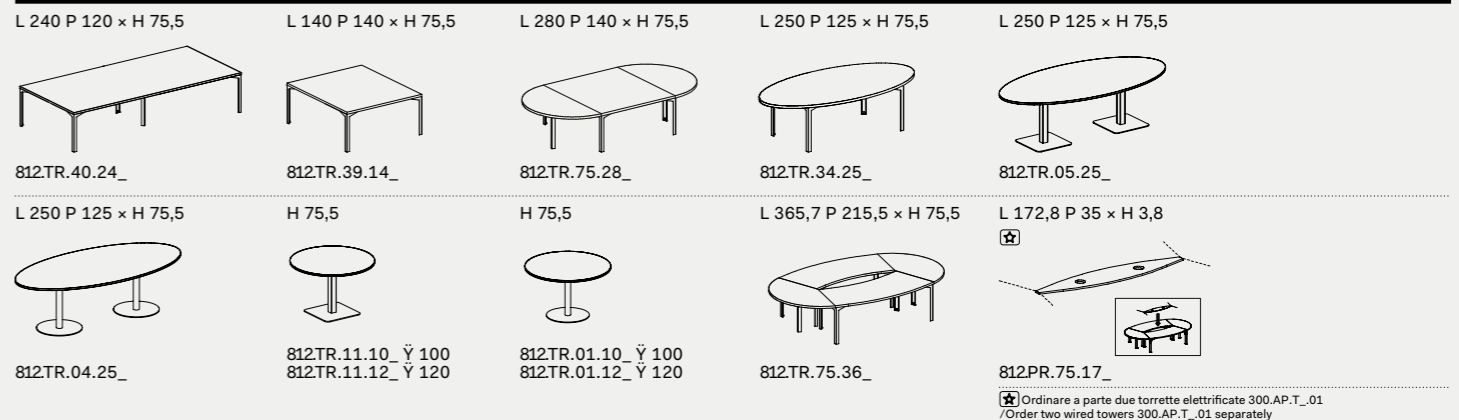

Tavoli scrivania con asole e 2 top access/Desks with opening and 2 top access

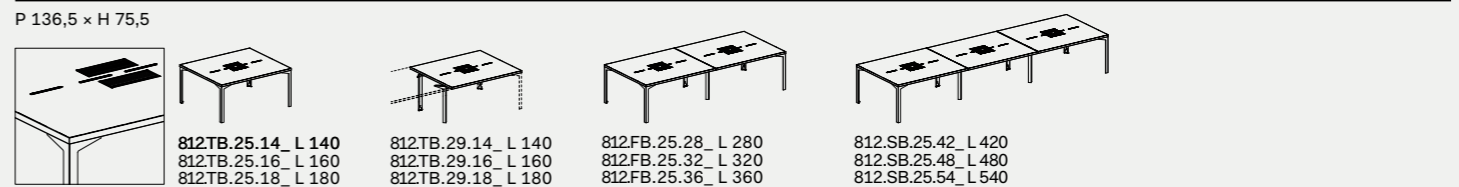

Note:

- 1 Le dimensioni sono espresse in cm - consultare il listino prezzi per le caratteristiche tecniche, i codici degli articoli e delle finiture/Dimensions are stated in cm - for technical characteristics, article code numbers and finishing see price list;
- 2 Per la scelta dei contenitori e degli accessori vari, consultare il relativo listino o catalogo/To choose storage units and accessories, please check correspondent price list or catalogue;
- 3 Per eventuali altre composizioni e combinazioni, vedere relativo catalogo della serie/For additional compositions and combinations, please check the catalogue of the specific series;

DVO S.R.L. con unico socio  
Via XX Settembre, 272  
Casella Postale n. 65  
U.P. Roveredo in Piano  
33080 Roveredo in Piano (PN)  
Italy

Tel. +39 0434 386 111  
Fax +39 0434 386 112  
www.dvo.it  
info@dvo.it

**Art Director**  
Enzo Berti

**Rendering**  
Nudesignstudio  
Lone Studio

**Stylist**  
Mara Zambon

**Issue 01**  
**April 2021**

**Foto e testi copyright**  
**DVO non riproducibili.**  
La venditrice si riserva  
la facoltà di apportare  
al prodotto eventuali  
modifiche tecniche,  
dimensionali ed estetiche  
in qualsiasi momento  
senza preavviso.

Pictures and text are  
DVO copyright, duplicate  
forbidden. The selling  
Company reserves the  
right to introduce changes  
to products regarding  
sizes and aesthetical  
or technical aspects at  
any timewithout notice.



DVO S.R.L. - AZIENDA CERTIFICATA / CERTIFIED COMPANY



Richiedi i prodotti certificati FSC® / Request for FSC® certified products

Il marchio della  
gestione forestale  
responsabile

dvo\_

DVO S.R.L. con unico socio  
Via XX Settembre, 272  
Casella Postale n. 65  
U.P. Roveredo in Piano  
33080 Roveredo in Piano (PN)  
Italy

Tel. +39 0434 386 111  
Fax +39 0434 386 112  
[www.dvo.it](http://www.dvo.it)  
[info@dvo.it](mailto:info@dvo.it)