DV700 Receptions

dvo_

DV700 Receptions

Cod.	Pag.
DV702 Led	004
DV701 Abako	032
DV703 Qubo	058

Receptions

DV702 Led

Design:
Antonio Morello

Comp. N°1A

IT L'espressione esatta di chiarezza costruttiva – Una linea dedicata all'accoglienza, funzionale al dialogo e all'operatività. Funge da primo contatto, è l'elemento che relaziona l'utente con l'azienda attraverso una chiarezza lineare ben definita ed elegante. Con i suoi pannelli retroilluminati trasforma l'ambiente circostante in pura magia.

EN The precise expression of constructive clarity – This system is dedicated to welcoming areas. It is designed to promote conversation and work efficiency. Serving as first contact, Led introduces the visitor to the company through a well defined, elegant linear clarity; with its backlit panels it transforms the environment into pure magic.









DV702 Led

Design:
Antonio Morello

Comp. N°1B







DV702 Led

Design:
Antonio Morello

Comp. N°2







DV702 Led

Design:
Antonio Morello

Comp. N°3







Moduli bancone e fianchi/Reception units and sides

Pannelli verticali sp. 1.8 cm in melaminico (*) o laminato (**)/
Vertical panels 1.8 cm thick in melamine (*) or laminate (**)

WL  **	NM  *	RC  *	RM  * E
Bianco lucido/ Glossy white	Noce "Maroncelli"/ "Maroncelli" walnut	Rovere chiaro/ Light oak	Rovere Moro/ Dark oak

Piani di lavoro sp. 1.8 cm, in melaminico/
Worktops 1.8 cm thick, in melamine

WN 	NM 	RC 	RM  E
Bianco/White	Noce "Maroncelli"/ "Maroncelli" walnut	Rovere chiaro/ Light oak	Rovere Moro/ Dark oak

Zoccoli e profili in alluminio/
Base metal frames and profiles in aluminium

H

Alluminio/
Aluminium

Top sp. 1.5 cm, in vetro temprato retrolaccato/
Top 1.5 cm thick, rear-lacquered tempered glass

WN

Retrolaccato bianco/
Rear lacquered white

Gambe terminali - intermedie in tubolare metallico/
Tubular metal end - intermediate legs

W  Bianco/ White	H  Alluminio/ Aluminium
---	--

Pannelli Led sp. 0.4 cm, in Metacrilato/
Led panels 0.4 cm thick, in Methacrylate

Opalino bianco + telaio alluminio/
Opal white + aluminium frame

Note

Su specifica richiesta è possibile ordinare abbinamenti tra pannelli e piani di lavoro diversi da quelli previsti a listino. Eventuali richieste di pannelli in metacrilato con illuminazione Led con colorazioni e finiture differenti, verranno valutate di volta in volta dall'ufficio commerciale./On specific request, front panels, side panels, and worktops can be supplied in non-standard finishes. Requirements for special finishes for the methacrylate Led panels with lighting will be studied case by case by the commercial department.

E Fino ad esaurimento/Until exhaustion.

Moduli bancone standard/Standard counter units

P 85,5 x H 112	L 85,5 P 85,5 x H 112	L 85,5 P 86,5 x H 112
702.MB.11.08_ L 80 702.MB.11.12_ L 120 702.MB.11.18_ L 180 Moduli dritti / Straight counter units	702.MB.13.08_ Raccordo 90° 2 vie / 2 Way connection counter unit	702.MB.14.08_ Terminale 90° Dx - Sx / Terminal counter unit 90° R - L

Moduli bancone con Led/Counter units with Led

P 85,5 x H 112	L 85,5 P 85,5 x H 112	L 85,5 P 86,5 x H 112
702.MB.11.08_ + Led L 80 702.MB.11.12_ + Led L 120 702.MB.11.18_ + Led L 180 Moduli dritti / Straight counter units	702.MB.13.08_ + Led Raccordo 90° 2 Vie / 2 Way connection counter unit	702.MB.14.08_ + Led Terminale 90° Dx - Sx / Terminal counter unit 90° R - L

Moduli bancone con piano conversazione/Counter units with conversation top

P 105 x H 74	L 82 P 8 x H 73	L 8 P 1 x H 34	L 8 P 1 x H 71,5
702.MB.12.08_ L 80 702.MB.12.12_ L 120 702.MB.12.18_ L 180 Modulo conversazione / Conversation counter unit	702.FC.13.08_ Dx - R/Sx - L Fianchi terminali conversazione / Terminal sides for conversation counter units	702.CT.A1.01 Copertura superiore conversazione / Upper cover element for conversation counter unit	702.CT.B1.01 Copertura terminale conversazione / Terminal cover element for conversation counter units

Gambe/Legs

Dx/R	Sx/L
702.GT.11.00 Gamba terminale / Terminal leg Dx - R/Sx - L	702.GM.11.00 Gamba intermedia / Middle leg

Componenti per bancone/Components for counter units

L 82 P 8 x H 108	L 8 P 1 x H 108	L 46 P 81,5 x H 112	L 46 P 81,5 x H 112
702.FC.11.08_ Fianchi terminali / Terminal sides Dx - R/Sx - L	702.FC.12.08_ Fianco intermedio / Middle side	702.CT.10.01 Copertura terminale / Terminal cover element	702.MC.11.04_ Moduli contenitore / Storage unit

Allunghi laterali/Lateral extensions

P 65 x H 74	P 80 x H 74	P 65 x H 1,8
801.TD.01.08_ L 80 801.TD.01.10_ L 100 801.TD.01.12_ L 120	801.TD.02.08_ L 80 801.TD.02.10_ L 100 801.TD.02.12_ L 120	801.AL.01.08_ L 80 801.AL.01.10_ L 100 801.AL.01.12_ L 120

Cassettiere portanti/Carrying pedestals

L 42 P 65 x H 72,2	L 42 P 65 x H 72,2	H 2,5
550.CS.30.04_	550.CS.40.04_	550.CG.11.04 Zoccolo (Optional) / Base frame (Optional)

Cassettiere/Pedestals

L 42 P 57 x H 55,5	L 32,2 P 54,2 x H 55,6	L 42,2 P 54,2 x H 55,6
550.CS.10.04_ Melaminico/Melamine	550.CS.1M.03_ Metalliche/Metallic	550.CS.2M.04_ Metalliche - Vaschetta porta cancelleria inclusa / Metallic - Stationery tray included

Canalizzazione - Elettificazione/Wire-Management - Electrification

P 10,2 x H 4,5	P 10,2 x H 4,5	L 80 P 10,2 x H 4,5
702.AP.01.08 L 80 702.AP.01.12 L 120 702.AP.01.18 L 180	702.AP.01.07	702.APT.1.08

702.AP.03.01	300.AP.F1.00	702.DM.01.00	702.DM.02.00

300.AP.S1.02 L 20,5 300.AP.S1.03 L 30 300.AP.S1.04 L 42	300.AP.T4.01 300.AP.T5.01 - UK 300.AP.T6.01 - US	702.AC.01.00	300.AC.06.05

Bracci porta video/Arms for video support

300.AC.04.01 Braccio porta video mobile su piano / Dynamic arm for video support on deskbase	300.AC.04.02 Doppio braccio porta video mobile su piano / 2 dynamic arms for video support on deskbase	300.AC.02.01 Braccio porta video mobile su piano / Dynamic arm for video support on deskbase

Note:

- La finitura impiallacciato delle cassette non è in pronta consegna. Per la disponibilità contattare l'ufficio commerciale / Pedestals veneered finish is not in prompt delivery. Please contact the commercial department to check availability;
 - Per portacancelleria cassette, vedi capitolo DV300-Accessori / For stationary tray, see chapter DV300-Accessories;
 - Progettare la composizione del bancone ed aggiungere: n°1 gamba intermedia, o fianco intermedio, o modulo contenitore per ogni collegamento tra due moduli; n°1 gamba terminale Dx o Sx, o fianco terminale Dx o Sx, o fianco finale del bancone; coperture terminali nella stessa quantità delle gambe terminali; copertura superiore per ogni collegamento tra modulo conversazione e modulo bancone / When designing the counter composition, add the following elements: n°1 middle leg or middle side or a storage unit for each connection between two counters; n°1 terminal leg (RH or LH) or terminal side (RH or LH), or terminal side for conversation counter unit or a storage unit on each side of the counter unit; add the terminal covers elements according to the same quantity of terminal legs; upper cover element for the connection between the conversation counter unit and the standard counter unit;
 - Le dimensioni sono espresse in cm - consultare il listino prezzi per le caratteristiche tecniche, i codici degli articoli e delle finiture / Dimensions are stated in cm - for technical characteristics, article code numbers and finishing see price list;
- Prodotti non in pronta consegna. Per la disponibilità contattare l'ufficio commerciale / Items not in prompt delivery. Please contact the commercial department to check availability;
 - Articoli prodotti solo su richiesta / Items produced only on demand;
 - Fino ad esaurimento / Until exhaustion;
 - Con serratura / With lock;
 - Componenti non collegabili con modulo conversazione / Items that cannot be connected with the conversation counter units.

DV701 Abako

Design:
Antonio Morello

Comp. N°1

IT Arredo d'immagine e professionalità – Elementi lineari, linee arrotondate, dettagli ad alta valenza formale e inediti accostamenti di materiali; come un biglietto da visita dell'azienda, primo luogo di contatto con il pubblico e l'esterno. Eleganza e ospitalità, efficienza e rapidità sono caratteristiche di un sistema ideato per rispondere alle esigenze di rappresentanza in un moderno ambiente di lavoro.

EN Furnishing with style and professionalism – Rounded shapes, linear elements, formal details and innovative combinations of materials become the company's business card, since it is the first area of contact between visitors and outside world. Elegance and hospitality, efficiency and rapidity are the very characteristics of a system conceived to fulfill a company's representation requirements in a modern working environment.







DV701 Abako

Design:
Antonio Morello

Comp. N°2







DV701 Abako

Design:
Antonio Morello

Comp. N°3A









DV701 Abako

Design:
Antonio Morello

Comp. N°3B



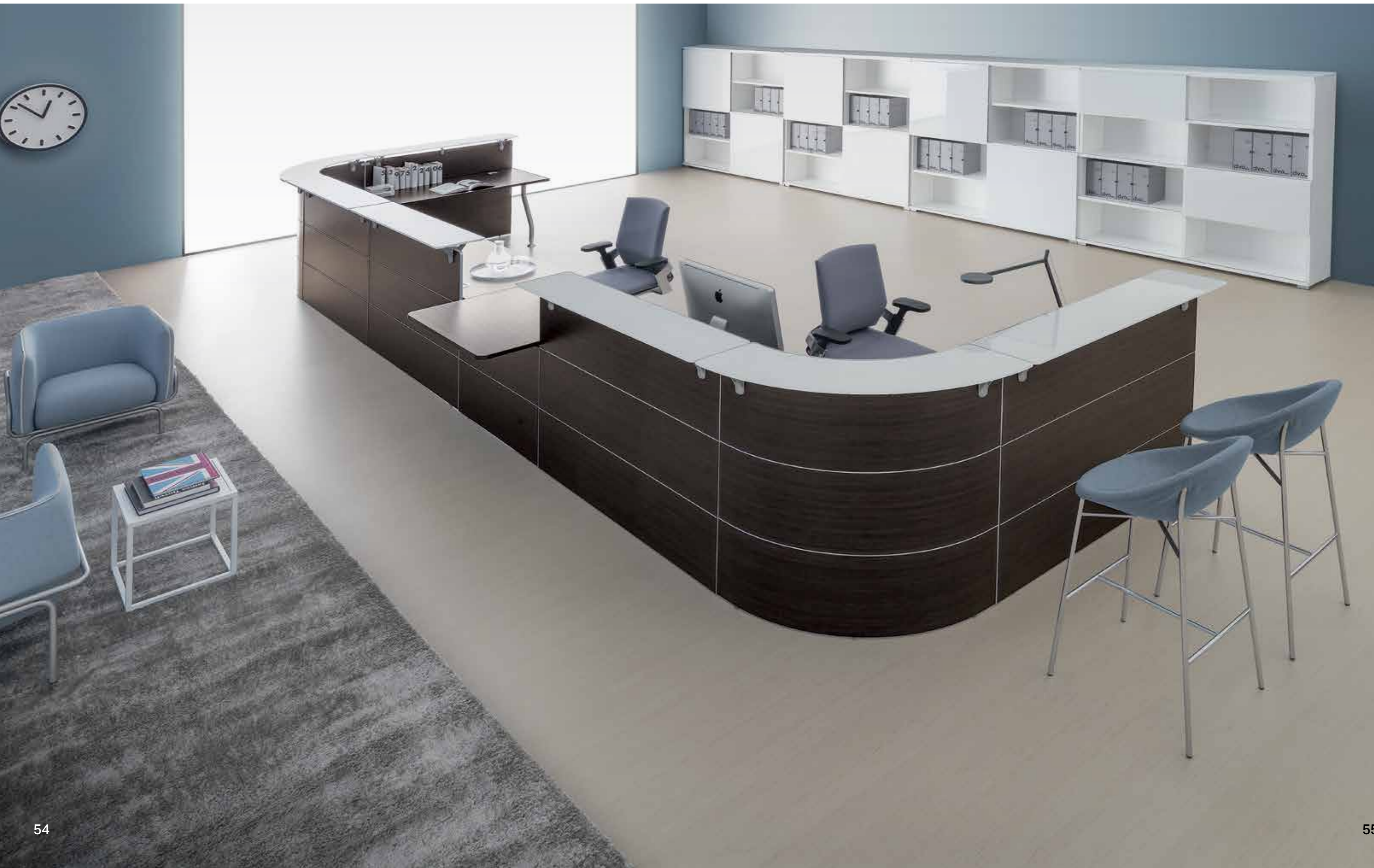

Moduli bancone in melaminico o laminato / Reception units melamine or laminate finishes

Pannelli verticali sp. 1.8 cm, in melaminico (*) o laminato (**)/ Vertical panels 1.8 cm thick, in melamine (*) or laminate (**)



Piani di lavoro sp. 2.5 cm, in melaminico / Worktops 2.5 cm thick, in melamine



Top sp. 1.2 cm, in vetro temperato / Top 1.2 cm thick, tempered glass

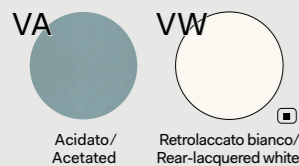

Gambe in metallo - Supporti top in zama Piedini in ABS / Metal legs - Die cast zama supports - ABS feet

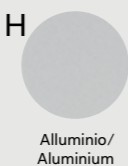

Note

Prodotti non in pronta consegna. Per la disponibilità contattare l'ufficio commerciale / Items not in prompt delivery. Please contact the commercial department to check availability.

Fino ad esaurimento / Until exhaustion.

Esempi di composizioni / Exemple of composition

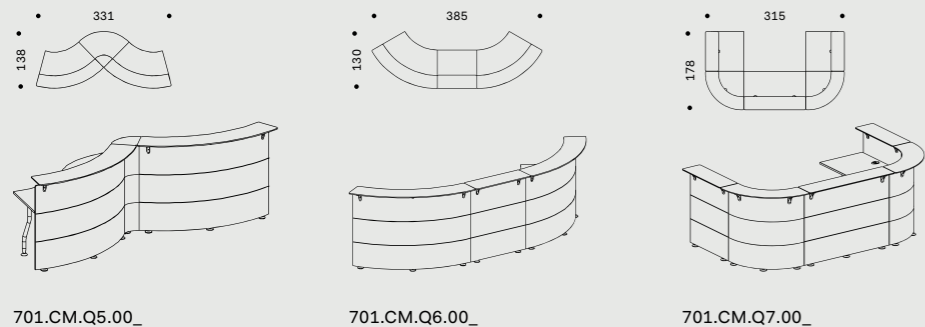
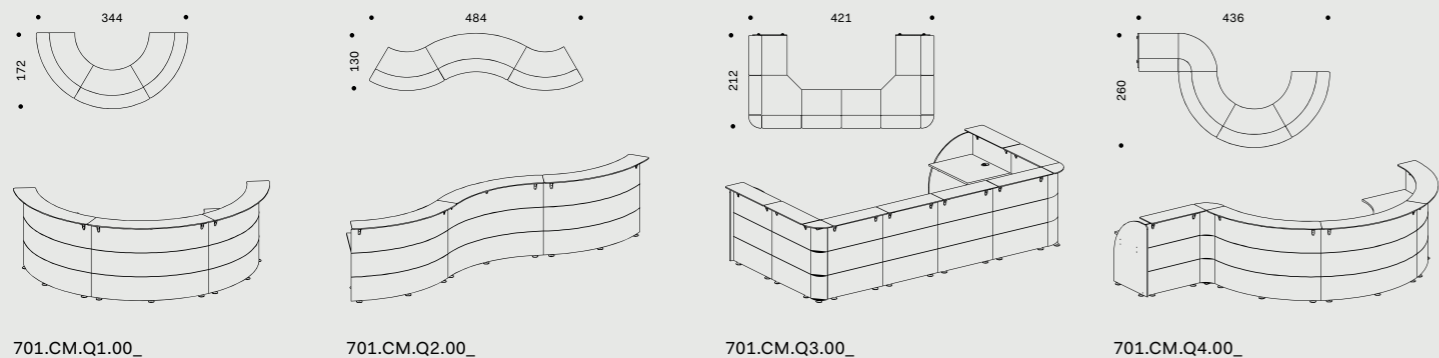

Moduli bancone dritti - Moduli bancone curvi 60° - Moduli bancone raccordo 90° / Straight counter units - 60° curved counter units - 90° counter corner units

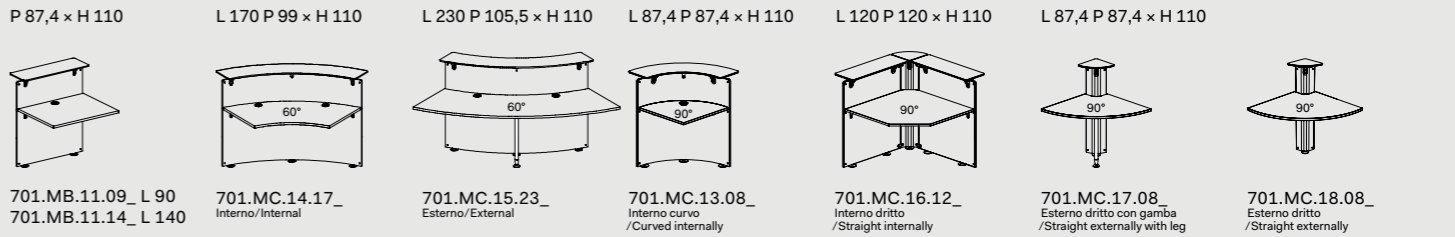

Note: Il top in vetro extrachiaro retrolaccato non è in pronta consegna. Per la disponibilità contattare l'ufficio commerciale / Extra-light rear-lacquered glass top is not in prompt delivery. Please contact the commercial department to check availability.

Moduli bancone con piano conversazione - Gambe - Fianchi / Counter units with conversation top - Legs - Sides

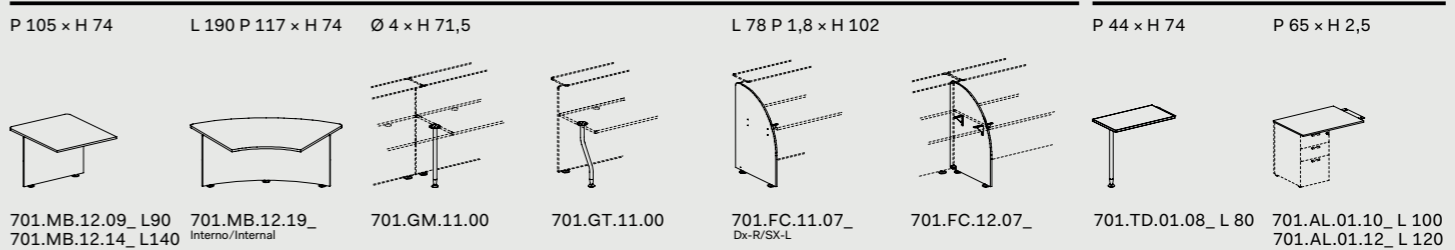

Cassettiere su ruote / Pedestals on castors

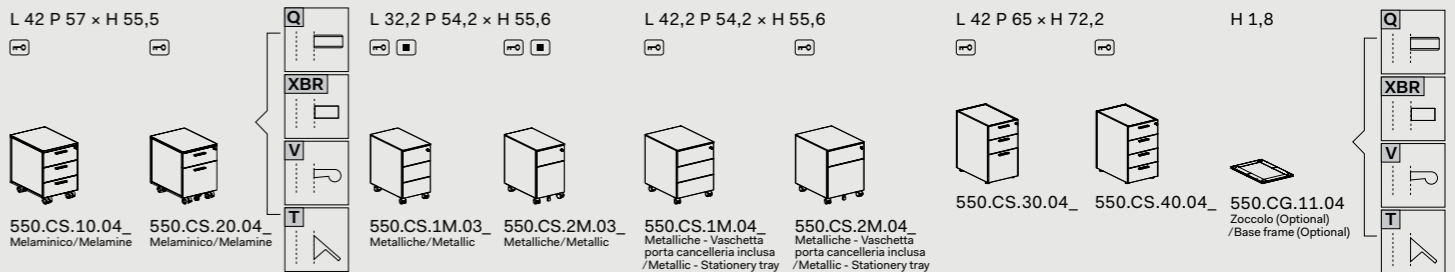

Canalizzazione - Elettificazione / Wire-Management - Electrification

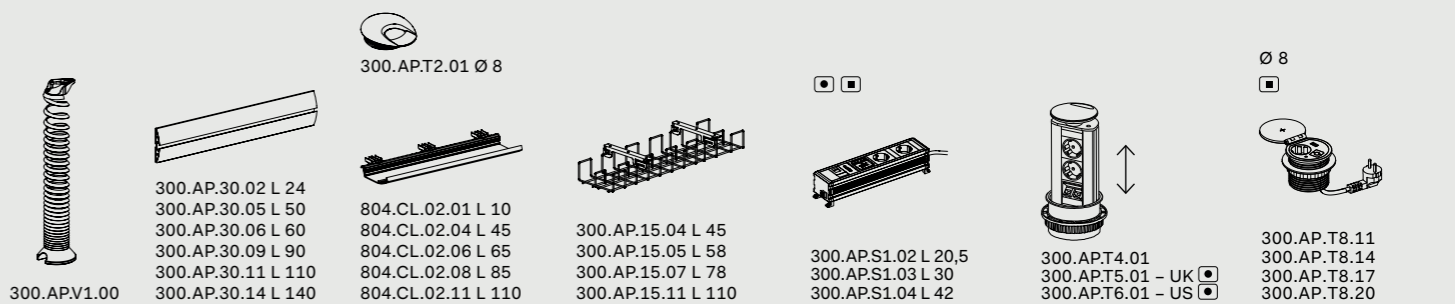

Accessori / Accessories

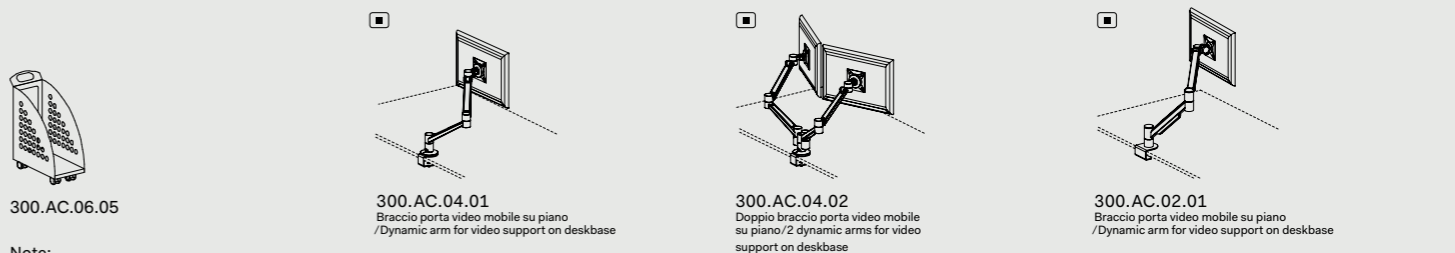

Note:

- Per la scelta dei contenitori e degli accessori vari, consultare il relativo listino o catalogo / To choose storage units and accessories, please check correspondent price list or catalogue;
- Le dimensioni sono espresse in cm - consultare il listino prezzi per le caratteristiche tecniche, i codici degli articoli e delle finiture / Dimensions are stated in cm - for technical characteristics, article code numbers and finishing see price list;
- La finitura impiacciato delle cassette non è in pronta consegna. Per la disponibilità contattare l'ufficio commerciale / Pedestals veneered finish is not in prompt delivery. Please contact the commercial department to check availability;
- Per portacancelleria cassette, vedi capitolo DV300-Accessori / For stationary tray, see chapter DV300-Accessories.

Prodotti non in pronta consegna. Per la disponibilità contattare l'ufficio commerciale / Items not in prompt delivery. Please contact the commercial department to check availability;

Articoli prodotti solo su richiesta / Items produced only on demand;

Con serratura / With lock.

Fino ad esaurimento / Until exhaustion;

DV703 Qubo

Design:
Antonio Morello

Comp. N°1A

IT Minimalismo e pulizia progettuale – La collezione si presenta come elemento dedicato all'accoglienza. Caratterizzato da elementi semplici che, accostati tra di loro, definiscono lo spazio di primo contatto. Conferisce alla reception un'immagine fresca e dinamica.

EN Minimalism and clean design - This collection showcases a modular reception desk solution. It's characterized by its simple in-line modules for defining the space of the first contact, giving the reception a fresh and dynamic image.









DV703 Qubo

Design:
Antonio Morello

Comp. N°1B

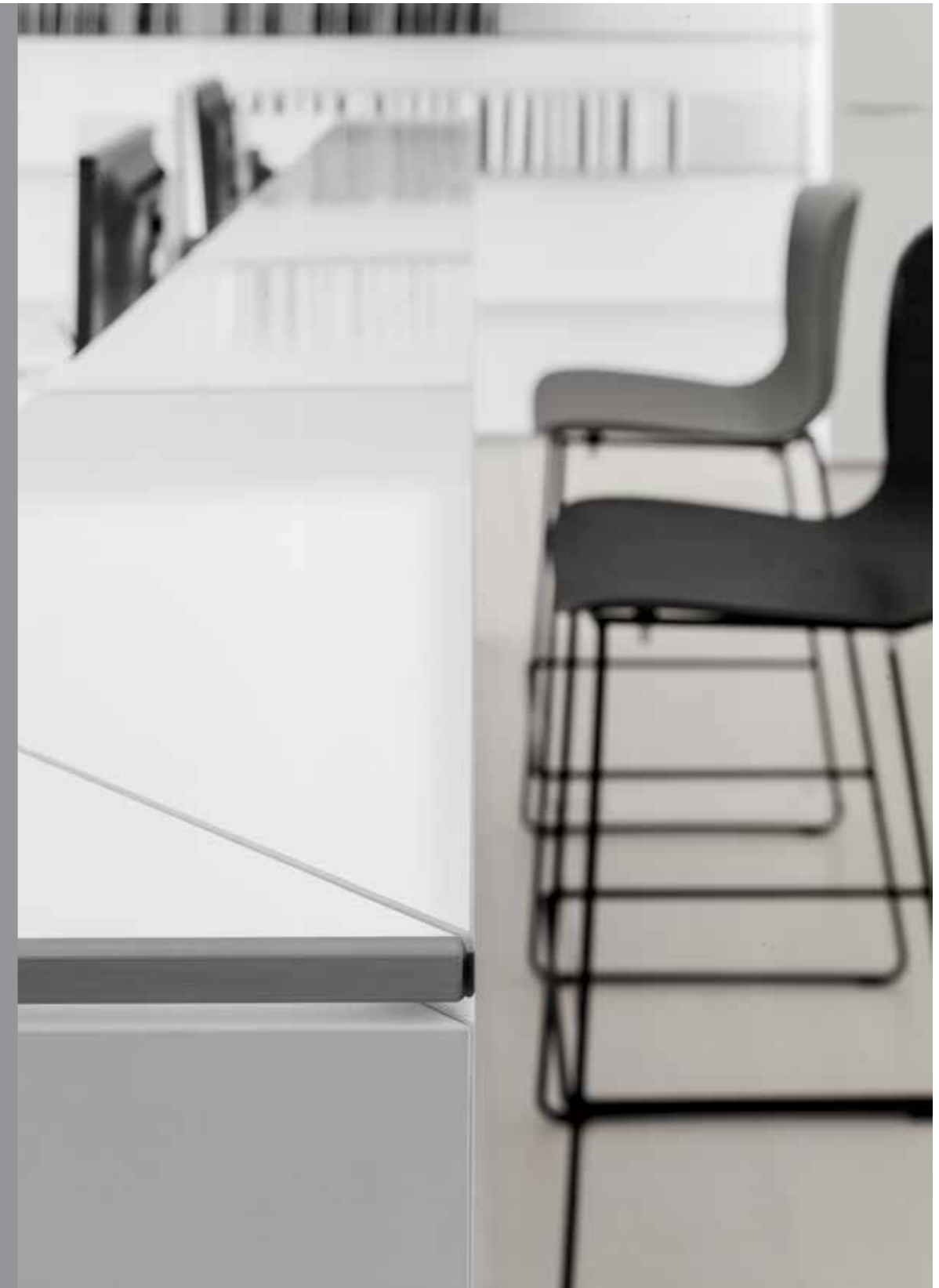



DV703 Qubo

Design:
Antonio Morello

Comp. N°2A





DV703 Qubo

Design:
Antonio Morello

Comp. N°2B





DV703 Qubo

Design:
Antonio Morello

Comp. N°3A





DV703 Qubo

Design:
Antonio Morello

Comp. N°3B







Moduli bancone/Counter modules

Pannelli verticali sp. 2.5 cm, in melaminico con bordi in ABS sp. 0.15 cm/Vertical panels 2.5 cm thick, in melamine with ABS edge-profile 0.15 cm thick



Piani di lavoro sp. 2.5 cm, in melaminico con bordi in ABS sp. 0.2 cm/Worktops 2.5 cm thick, in melamine with ABS edge-profile 0.2 cm thick



Abbinamento tops/Tops combinations

Top sp. 1.8 cm, in melaminico (*) o laminato (***) con bordi in PMMA bicolore sp. 0.15 cm/Top 1.8 cm thick, melamine (*) or laminate (***) with PMMA edges-profiles 0.15 cm thick

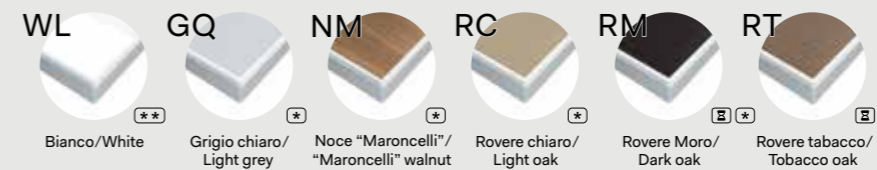

Colonna metallica / Metal column

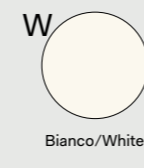

Zocchi in alluminio/Aluminium plinth

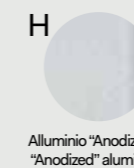

Supporti in zama / Supports in zamak

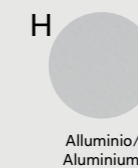

Box multiuso/Storage box

Box sp. 1 cm, in melaminico con bordi in ABS colore alluminio sp. 0.1 cm/Box 1 cm thick, in melamine with ABS edges-profiles 0.1 cm thick

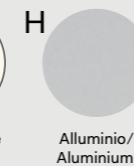

Composizione in gres/Gres composition

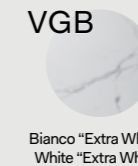

Top accettazione / Decorative top

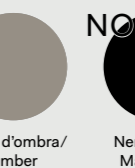
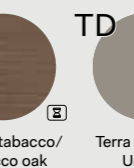
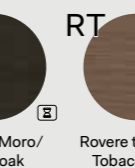
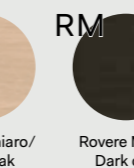
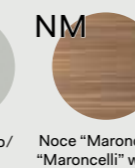
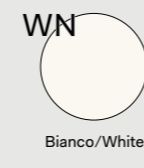

Note

Prodotti non in pronta consegna. Per la disponibilità contattare l'ufficio commerciale/Items not in prompt delivery. Please contact the commercial department to check availability. Fino ad esaurimento/Until exhaustion.

Moduli bancone standard/Standard counter units

P 84 x H 112,5
 703.MB.01.08_ L 80
 703.MB.01.14_ L 140
 703.MB.01.16_ L 160
 703.MB.01.20_ L 200
 Moduli dritti/Straight counter units

L 84 P 84 x H 112,5
 * 703.MB.03.08_
 Raccordo 90° a 2 vie
 /2 ways 90° connection unit

L 84 P 84 x H 112,5
 Dx/R
 703.MB.04.08_
 Terminale 90° Dx- Sx
 /Terminal counter unit 90° R - L

Componenti per moduli bancone/Components for counter units

P 2,5 x H 110
 703.SQ.01.08_ L 80
 703.SQ.01.14_ L 140
 703.SQ.01.16_ L 160
 703.SQ.01.20_ L 200
 Schiene per moduli dritti
 /Back panels for straight units

L 84 P 84 x H 110
 703.SQ.02.08_
 Schiene per moduli 90°
 /Back panels for 90° units

P 80 x H 2,5
 703.PQ.01.08_ L 80
 703.PQ.01.14_ L 140
 703.PQ.01.16_ L 160
 703.PQ.01.20_ L 200
 Piani scrivania per moduli dritti
 /Worktops for straight units

L 80 P 80 x H 2,5
 703.PQ.02.08_
 Piani scrivania per moduli 90°
 /Worktops for 90° units

Componenti per moduli bancone/Components for counter modules

P 30 x H 1,8
 703.TQ.01.08_ L 80
 703.TQ.01.14_ L 140
 703.TQ.01.16_ L 160
 703.TQ.01.20_ L 200
 Top per moduli dritti
 /Top for straight units

L 84 P 84 x H 1,8
 * 703.TQ.02.08_
 Top per raccordo 90° a 2 vie
 /Top for 90° units

L 84 P 84 x H 1,8
 Sx/L - Dx/R
 703.TQ.03.08_
 Top per terminali 90° Dx - Sx
 /R - L top for 90° terminal units

L 84 P 2,5 x H 112,5
 703.FC.01.08_
 Sx/L - Dx/R
 Fianchi terminali Dx - Sx
 /R - L terminal sides

L 5 P 5 x H 71,5
 703.GM.01.01
 Colonna intermedia
 /Intermediate slim column

P 2,5 x H 8
 703.ZB.01.08 L 80
 703.ZB.01.14 L 140
 703.ZB.01.16 L 160
 703.ZB.01.20 L 200
 Zoccoli per moduli dritti/Metal plinth for straight units (Optional)

L 84 P 84 x H 8
 703.ZB.02.08
 Zoccoli per moduli 90°
 /Metal plinth for 90° units (Optional)

* Non utilizzabile come terminale/It cannot be used as a terminal side

Componenti non collegabili con modulo conversazione/Items that cannot be connected with the conversation counter units

Moduli bancone con piano conversazione/Counter units with conversation top

L 140 P 115 x H 74
 703.MB.02.14_
 Modulo conversazione
 /Conversation counter unit

L 140 P 2,5 x H 71,5
 703.SQ.03.14_
 Schiena per modulo conversazione
 /Back panels for conversation unit

L 140 P 115 x H 2,5
 703.PQ.03.14_
 Piano per modulo conversazione
 /Worktop for conversation unit

L 84 P 2,5 x H 74
 703.FC.03.08_
 Sx/L - Dx/R
 Fianchi terminali per modulo conversazione
 /Terminal sides for conversation unit

L 28 P 2,5 x H 39
 703.CT.A1.02_
 Sx/L - Dx/R
 Fianchetti superiori per modulo conversazione
 /Small sides for conversation unit

Gli zoccoli sono optional e non sono previsti per i fianchi terminali / The aluminium plinths are optional and are not intended for end panels

Top accettazione/Decorative top

P 32,3 x H 74
 703.TA.01.14_ L 140
 703.TA.01.16_ L 160

L 35 P 24 x H 35
 300.AC.14.03
 Box Multiuso/Storage Box

Accessori/Accessories

Cassettiere/Pedestals

L 42 P 57 x H 55,5
 550.CS.10.04 Melaminico/Melamine
 550.CS.20.04 Melaminico/Melamine

L 32,2 P 54,2 x H 55,6
 550.CS.1M.03 Metalliche/Metallic
 550.CS.2M.03 Metalliche/Metallic

L 42,2 P 54,2 x H 55,6
 550.CS.1M.04 Metalliche - Vaschetta porta cancelleria inclusa /Metallic - Stationery tray included
 550.CS.2M.04 Metalliche - Vaschetta porta cancelleria inclusa /Metallic - Stationery tray included

L 42 P 65 x H 72,2
 550.CS.30.04 Cassettiere senza top per integrazione sotto il piano di lavoro / Pedestals without top to be integrated under the worktop
 550.CS.40.04

H 1,8
 550.CG.12.04 Zoccolo (Optional) /Base frame (Optional)

Composizione in gres/Gres composition

L 247 P 84 x H 112,5
 703.CM.P1

Bracci porta video/Arms for video support

300.AC.04.01
 Braccio porta video mobile su piano
 /Dynamic arm for video support on deskbase

300.AC.04.02
 Doppio braccio porta video mobile su piano/2 dynamic arms for video support on deskbase

300.AC.02.01
 Braccio porta video mobile su piano
 /Dynamic arm for video support on deskbase

Canalizzazione - Elettificazione/Wire-Management - Electrification

300.AP.V1.00

300.AP.15.05 L 58
 For 703.MB.01.08_/703.MB.04.08_
300.AP.15.08 L 88
 For 703.MB.01.20_
300.AP.15.11 L 110
 For 703.MB.01.14_/703.MB.02.14_
300.AP.15.14 L 140
 For 703.MB.01.16_

703.AP.01.04 L 45
 For 703.MB.03.08_

300.AP.S1.02 L 20,5
300.AP.S1.03 L 30
300.AP.S1.04 L 42

300.AP.T4.01
300.AP.T5.01 - UK
300.AP.T6.01 - US

300.AP.T8.11
300.AP.T8.14
300.AP.T8.17
300.AP.T8.20

300.AP.T2.01 Ø 8

300.AP.T7.01 Ø 6
300.AP.T8.01 Ø 8

703.LQ.03.00 L 55

703.KQ.03.00
 15W/100 - 240V ± 12V

300.AC.06.05_

Note:

- La finitura impiacciato delle cassette non è in pronta consegna. Per la disponibilità contattare l'ufficio commerciale/Pedestals veneered finish is not in prompt delivery. Please contact the commercial department to check availability;
- Per portacancelleria cassette, vedi capitolo DV300-Accessori/For stationary tray, see chapter DV300-Accessories;
- Per la scelta dei contenitori e degli accessori vari, consultare il relativo listino o catalogo/To choose storage units and accessories, please check correspondent price list or catalogue;
- Progettare la composizione del bancone ed aggiungere: n°1 gamba intermedia per ogni collegamento tra due moduli; n°1 fianco terminale dx o sx, o fianco terminale conversazione per ogni lato finale del bancone; copertura superiore per ogni collegamento tra modulo conversazione e modulo bancone /When designing the counter composition, add the following elements: n°1 middle leg for each connection between two counters; n°1 terminal side (RH or LH), or terminal side for conversation counter unit on each side of the counter unit; upper cover element for the connection between the conversation counter unit and the standard counter unit;
- Le dimensioni sono espresse in cm - consultare il listino prezzi per le caratteristiche tecniche, i codici degli articoli e delle finiture/Dimensions are stated in cm - for technical characteristics, article code numbers and finishing see price list;
- Prodotti non in pronta consegna. Per la disponibilità contattare l'ufficio commerciale/Items not in prompt delivery. Please contact the commercial department to check availability;
- Articoli prodotti solo su richiesta/Items produced only on demand;
- Con serratura/With lock.
- Fino ad esaurimento/Until exhaustion;

DVO S.R.L. con unico socio
Via XX Settembre, 272
Casella Postale n. 65
U.P. Roveredo in Piano
33080 Roveredo in Piano (PN)
Italy

Tel. +39 0434 386 111
Fax +39 0434 386 112
www.dvo.it
info@dvo.it

Art Director
Enzo Berti

Photo
Tobia Berti

Stylist
Mara Zambon

Issue 01
May 2021

Foto e testi copyright
DVO non riproducibili.
La venditrice si riserva
la facoltà di apportare
al prodotto eventuali
modifiche tecniche,
dimensionali ed estetiche
in qualsiasi momento
senza preavviso.

Pictures and text are
DVO copyright, duplicate
forbidden. The selling
Company reserves the
right to introduce changes
to products regarding
sizes and aesthetical
or technical aspects at
any time without notice.



DVO S.R.L. - AZIENDA CERTIFICATA / CERTIFIED COMPANY



Richiedi i prodotti certificati FSC® / Request for FSC® certified products

Il marchio della
gestione forestale
responsabile

dvo_

DVO S.R.L. con unico socio
Via XX Settembre, 272
Casella Postale n. 65
U.P. Roveredo in Piano
33080 Roveredo in Piano (PN)
Italy

Tel. +39 0434 386 111
Fax +39 0434 386 112
www.dvo.it
info@dvo.it