DV500 Storages

DV300 Accessories

dvo_

**DV500 Storages
DV300 Accessories**

Cod.	Pag.
DV503 Contenitori universali / Universal storages	004
DV504 Milo	038
DV505 Rio	070
DV522 Roma	096
DV525 Riga	108
DV527 Taba	118
DV530 Boiserie	130
DV545 Seul	142
DV549 Lockers	150
DV550 Cassettiere / Pedestals	162

DV500 Storages

DV503 Contenitori universali / Universal storages

Design:
Antonio Morello

IT I “Contenitori universali” rispondono concretamente alle diverse esigenze dello spazio di lavoro mediante una vasta gamma di moduli attrezzabili destinati all’archiviazione e al contenimento. L’abbinamento di materiali, finiture e colori creano infinite possibilità di composizioni e soluzioni. La qualità funzionale, formale ed estetica garantisce un prodotto esclusivo nella molteplicità delle dimensioni e delle tipologie.

EN The “Universal storage” units concretely respond to the different needs of a working environment through a wide range of modules that can be equipped and devoted to storage and filing. The combination of materials, finishes and colours create endless possibilities of compositions and solutions. The functional, formal and aesthetical quality guarantees an exclusive product in a variety of sizes and types.







**Contenitori universali /
Universal storage**

Altezza	Height	Larghezza	Width	Profondità	Depth
A - 84.5 cm	H - 33 1/4"	L - 45 cm	W - 17 3/4"	P - 35 cm	D - 13 3/4"
A - 129.3 cm	H - 51"	L - 90 cm	W - 35 1/2"	P - 45 cm	D - 17 3/4"
A - 164.5 cm	H - 64 3/4"				
A - 209.3 cm	H - 82 1/2"				

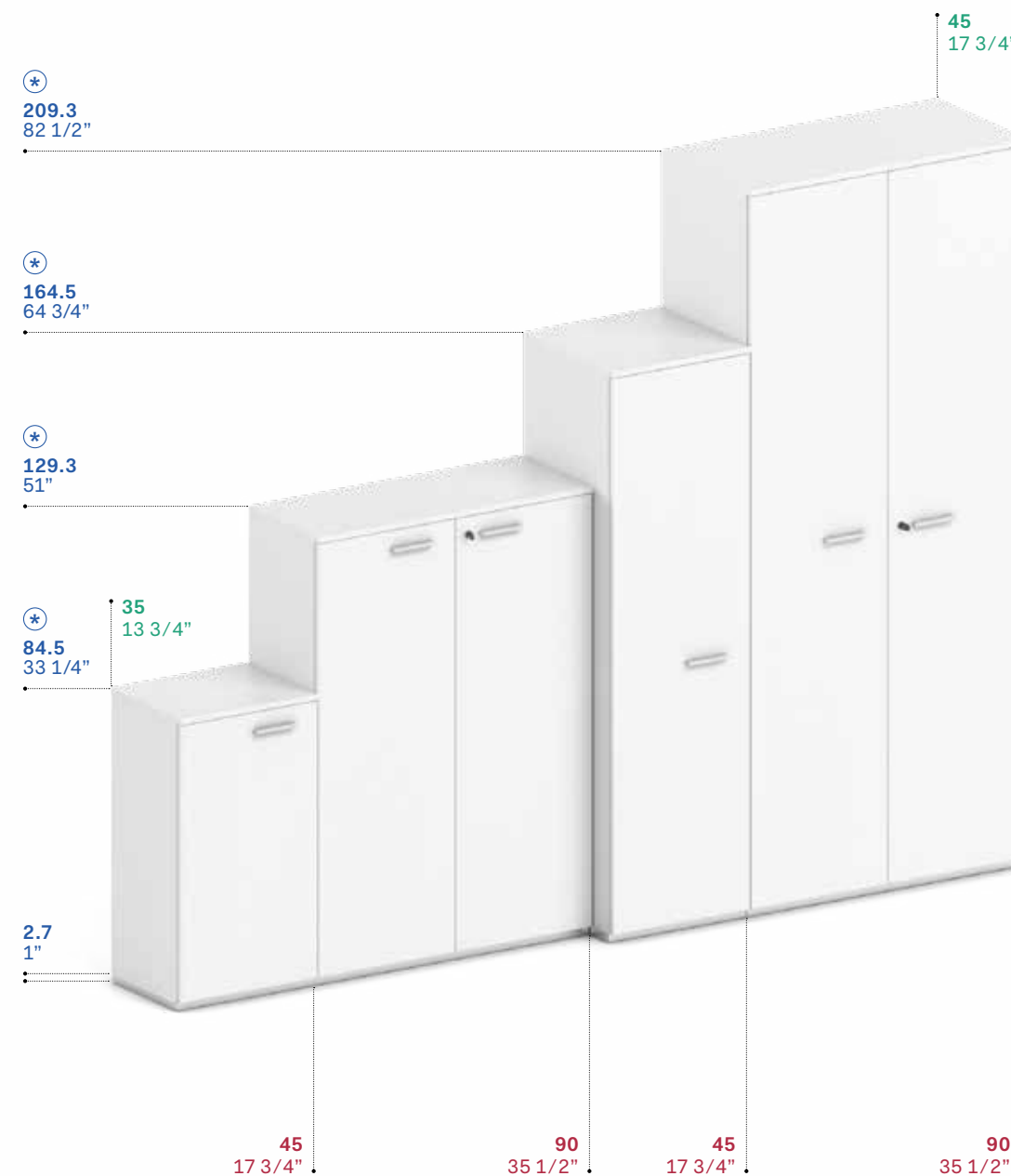

* Le dimensioni A indicate comprendono lo spessore dei top 1.8 cm /
The above H dimensions, include the 3/4" thickness of the top

Tipologie contenitori / Storage units type

Altezza A - Height	Larghezza L - Width	Profondità P - Depth
A - 82.7 cm H - 32 1/2"	L - 45 cm W - 17 3/4"	P - 33.2 cm D - 13"
A - 127.5 cm H - 50 1/4"	L - 90 cm W - 35 1/2"	P - 43 cm D - 17"
A - 162.7 cm H - 64"		P - 45 cm D - 17 3/4"
A - 207.5 cm H - 81 3/4"		

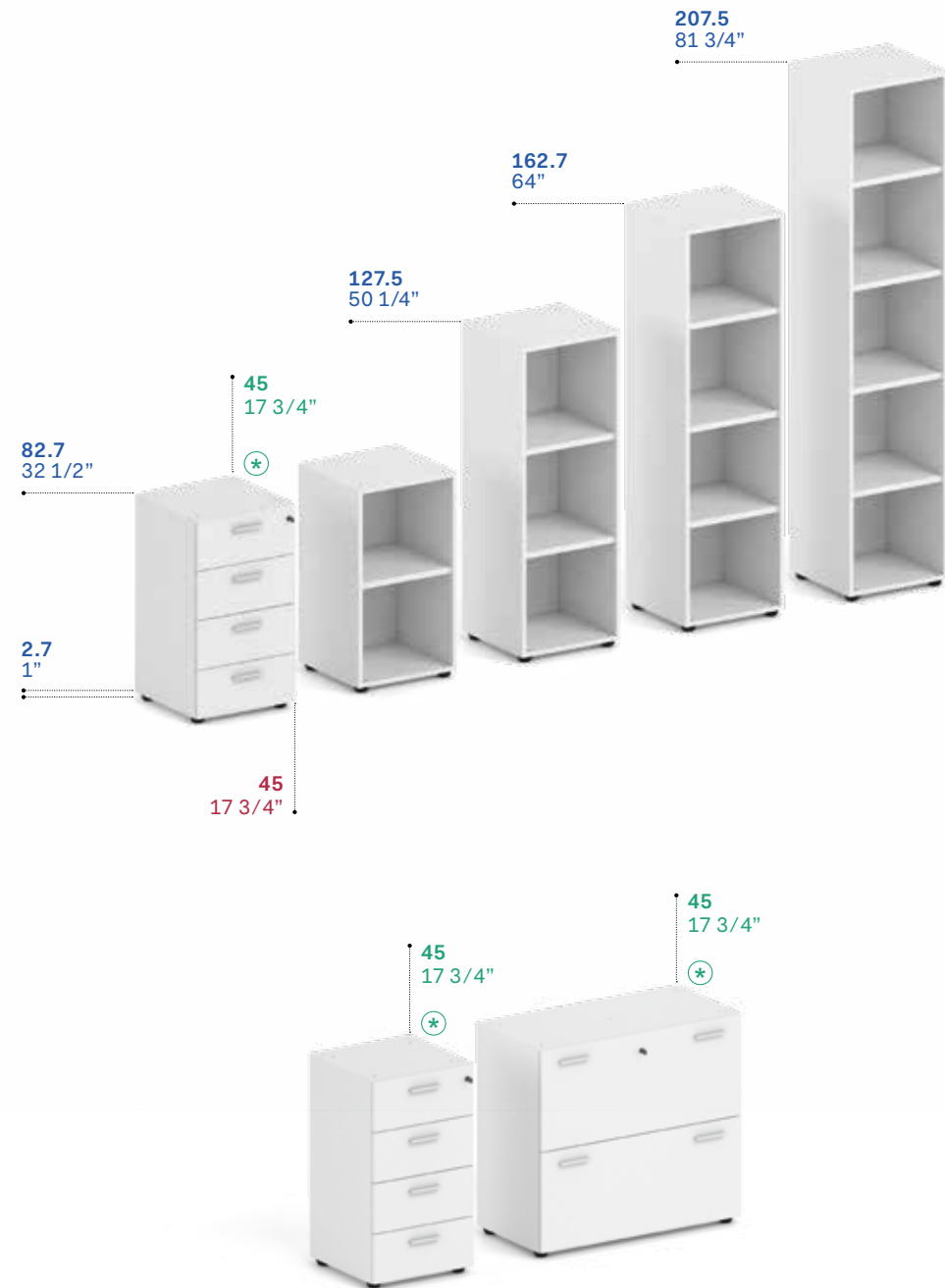

* Disponibili solo con profondità 45 cm / Only available in 17 3/4" depth

Note: I Contenitori Universali sono disponibili in diverse dimensioni, finiture, tipologie e precisamente: a giorno o con ante in legno o in vetro, oppure con cassetti normali o classificatori. Essi si possono comporre e sovrapporre tra di loro (H max. 253 cm) e vanno obbligatoriamente completati con i Top sp. 1.8 cm. Ripiani posizionabili. Zoccoli e accessori sono opzionali. / The Universal Storage Units are available in several sizes, finishes and types: open and with wooden or glass doors, with standard or filing drawers. They can be combined and stacked (maximum height: 99 2/4") differently, and they need to be always completed with a top of 3/4" thickness. Adjustable shelves. Metal base frames and accessories are Optional.

Tipologie contenitori / Storage units type

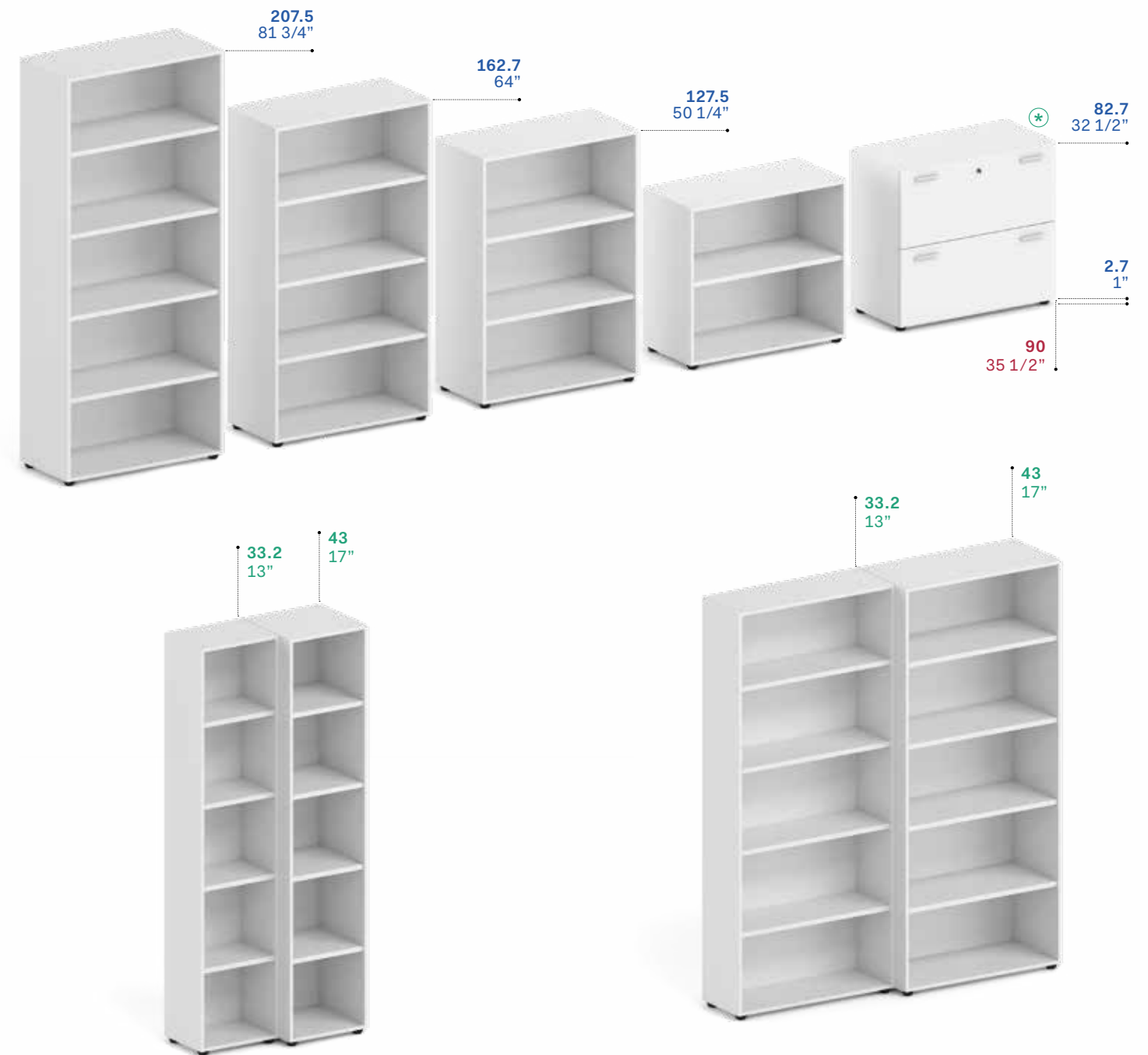

Scocche in melaminico sp. 1.8 cm / Melamine bodies 3/4" thick

Ripiani in melaminico sp. 2.5 cm / Melamine shelves 1" thick

Ripiani in metallo sp. 2.5 cm / Metal shelves 1" thick

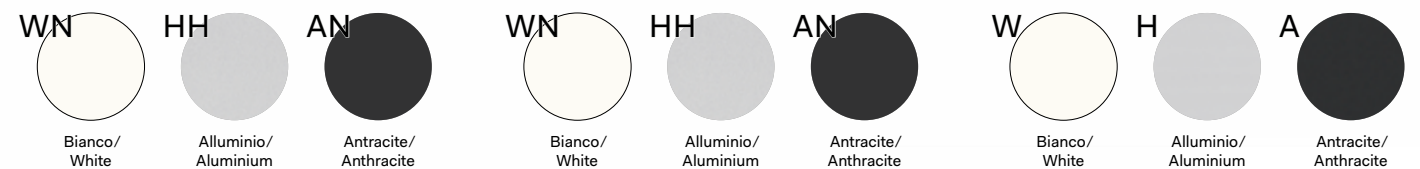

Ante piene (sp. 1.8 cm) /
Wooden doors (3/4" thick)

Con serratura /
With lock

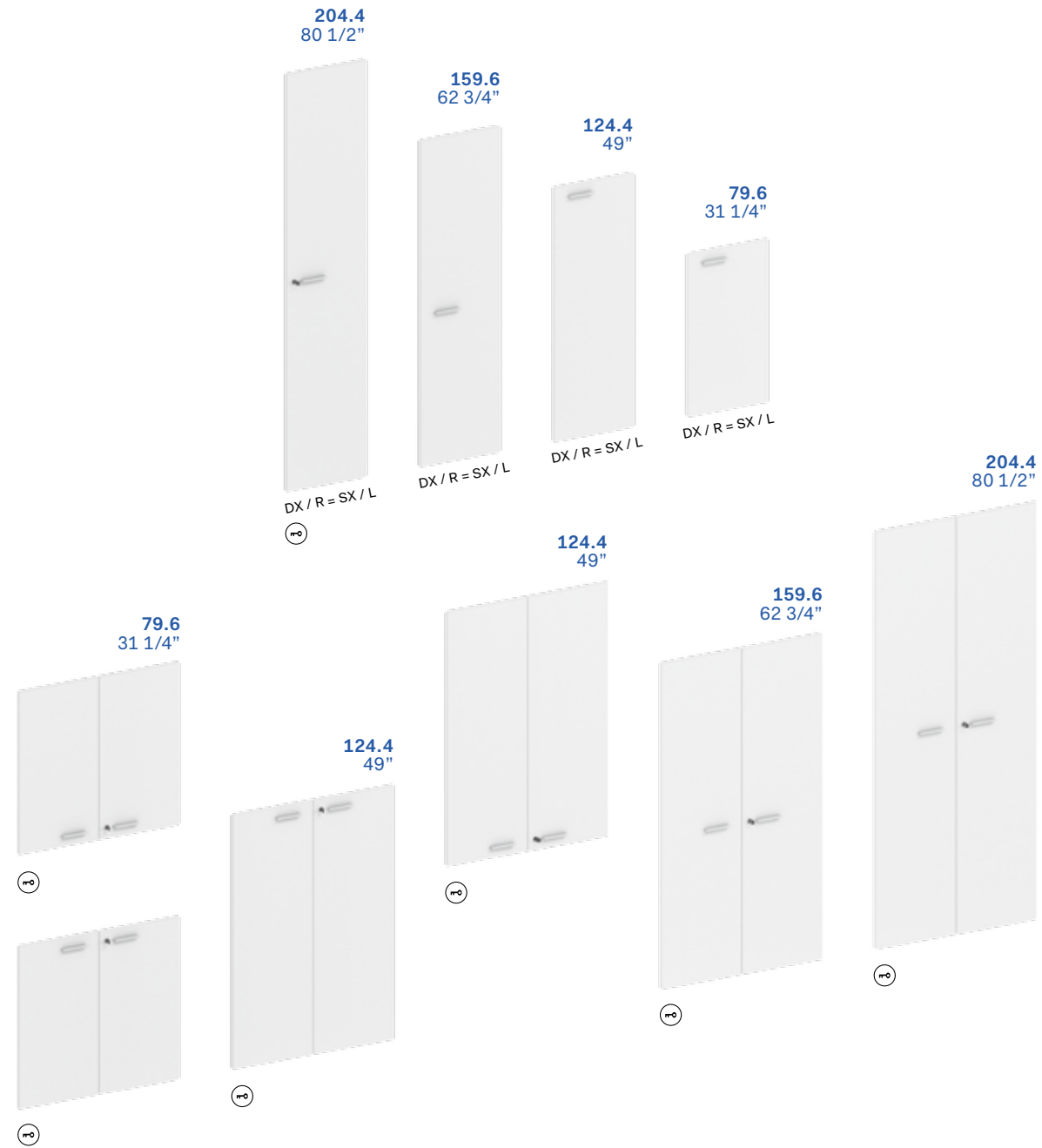

Finiture in melaminico (*), laminato (***) o impiallacciato sp. 1.8 cm
Melamine (*), laminate (***) or veneered finishes 3/4" thick

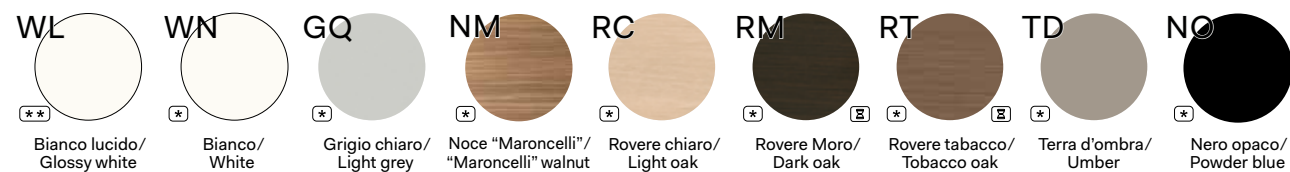

Impiallacciato solo su richiesta /
Veneered only on request

Fino ad esaurimento /
Until exhaustion

Ante vetro acidato con telaio in alluminio (sp. 2 cm) /
Acetated glass doors with aluminium frame (3/4" thick)

Con serratura /
With lock



Finiture vetro temprato, sp. 0.4 cm / Tempered glass finish, 1/4" thick



Ante vetro retrolaccato con telaio alluminio (sp. 2 cm) /
Rear-lacquered glass doors with aluminium frame (3/4" thick)

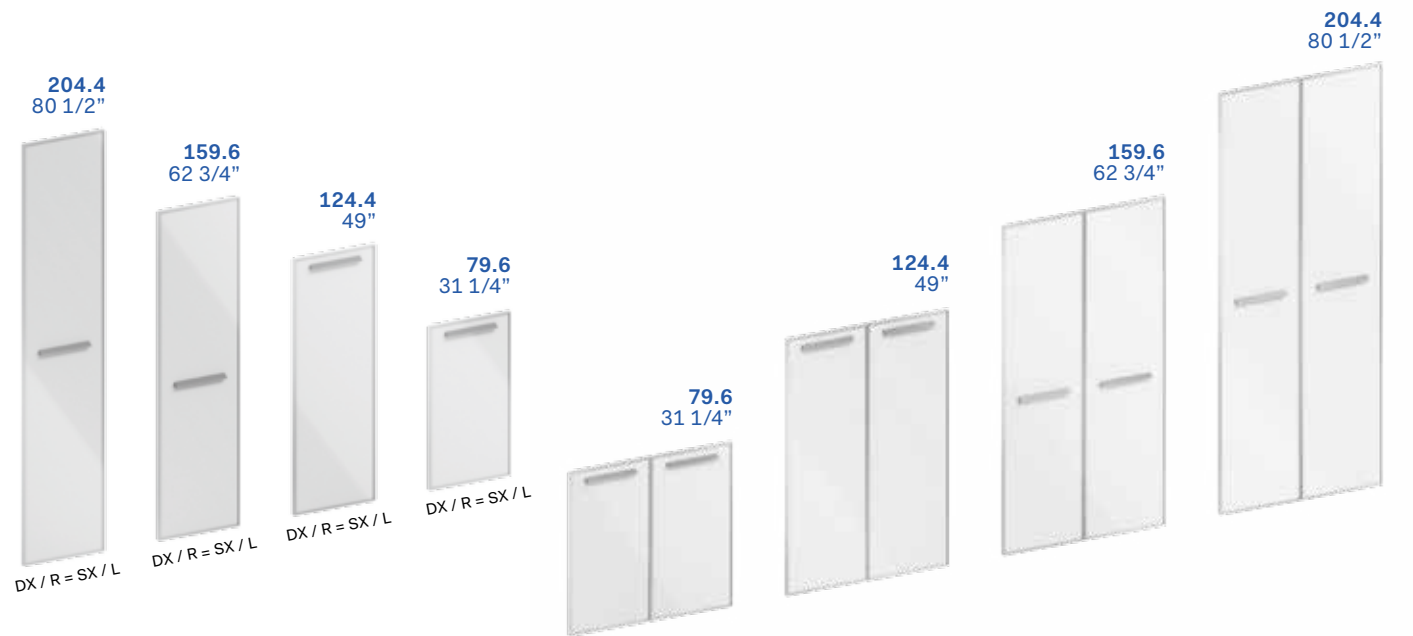

Finiture vetro temprato, sp. 0.4 cm / Tempered glass finish, 1/4" thick

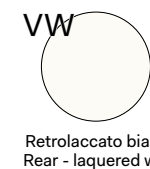

Retrolaccato bianco/
Rear-lacquered white

Tipologia maniglie /
Handles types

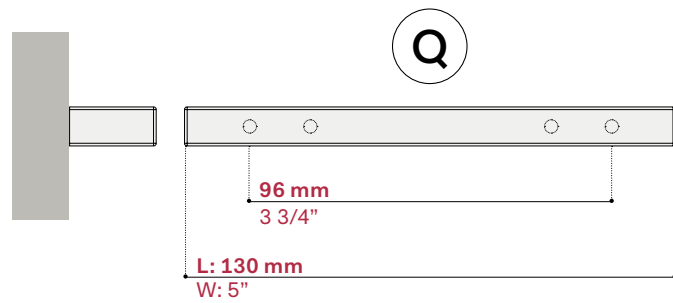

Maniglia per ante piene, vetro acidato con telaio in alluminio /
Handle for wooden doors, acetated glass with aluminium frame

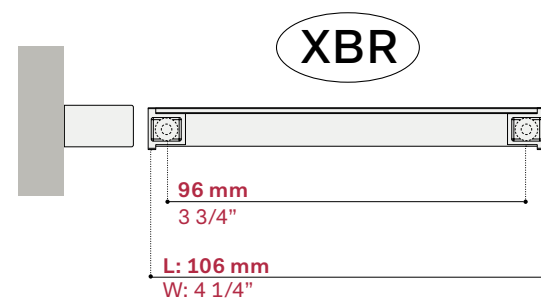

Maniglia per ante piene, vetro acidato con telaio in alluminio /
Handle for wooden doors, acetated glass with aluminium frame

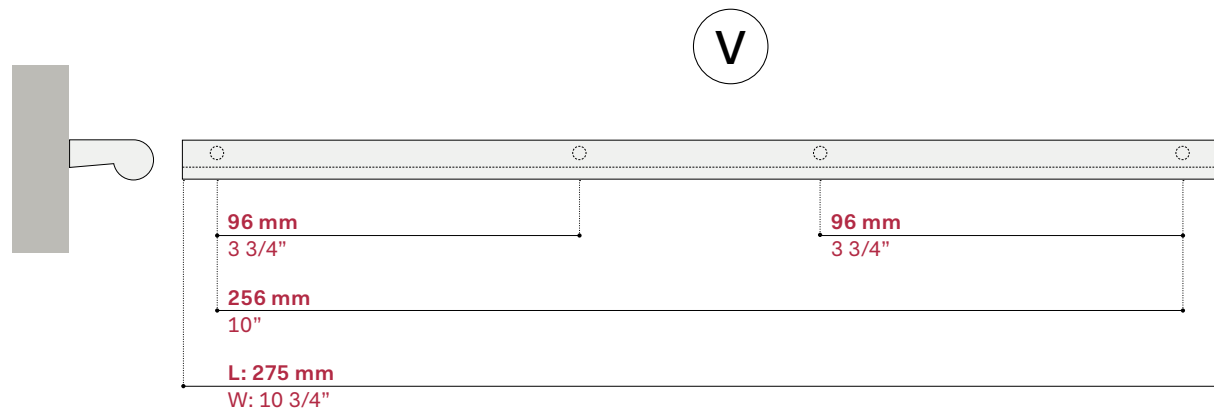

Maniglia per ante piene, vetro acidato o vetro retrolaccato con telaio in alluminio /
Handle for wooden doors, acetated or rear-lacquered glass with aluminium frame

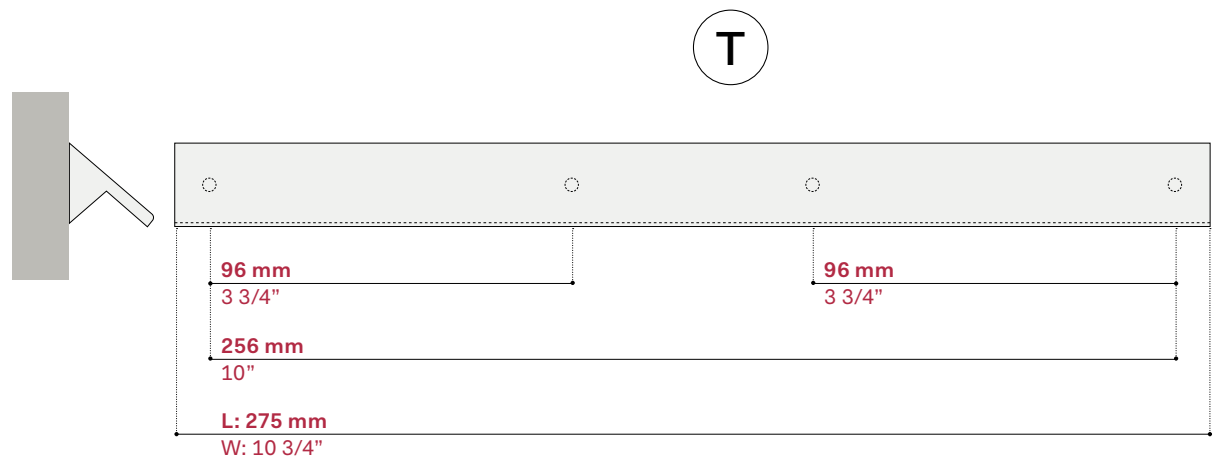

Maniglia per ante piene, vetro acidato o vetro retrolaccato con telaio in alluminio /
Handle for wooden doors, acetated or rear-lacquered glass with aluminium frame

Finiture maniglie Q V T / Q V T Finishing handles

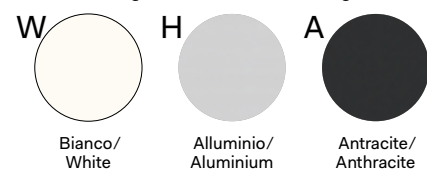

Finitura maniglie XBR / XBR Finishing handles

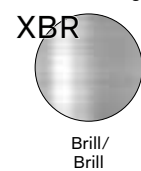

Maniglie per ante piene /
Handles for wooden doors

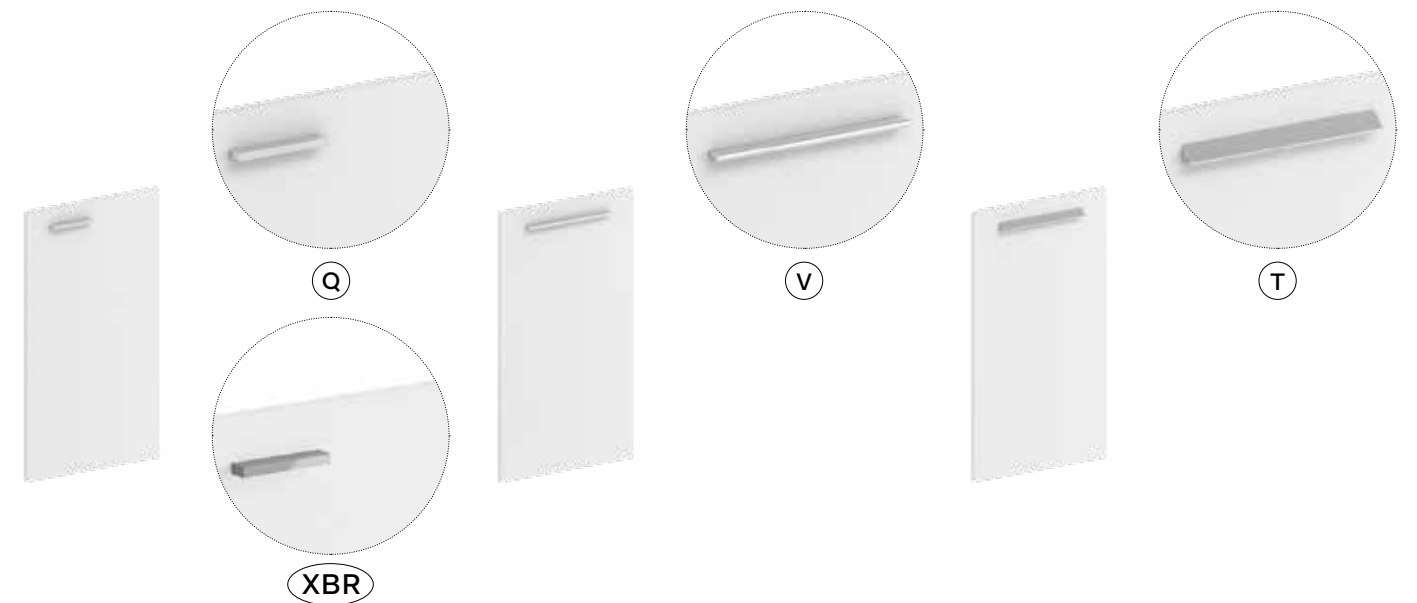

Maniglie per ante in vetro retrolaccato con telaio in alluminio /
Handles for rear-lacquered glass doors

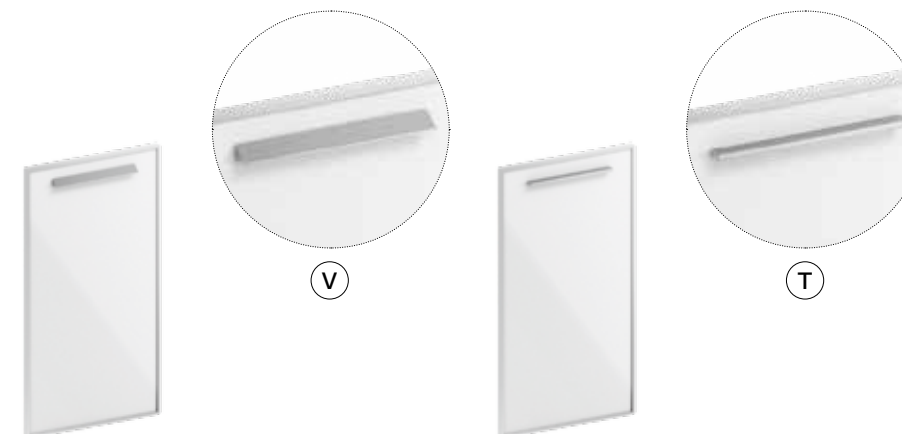

Maniglie per ante in vetro acidato con telaio in alluminio /
Handles for acetated glass doors with aluminium frame



Configurazioni contenitori / Storage unit configurations

Altezza	Height	Larghezza	Width	Profondità	Depth
A - 82.7 cm	senza top H - 32 1/2" without top	L - 45 cm	W - 17 3/4"	P - 35 cm	D - 13 3/4"
A - 84.5 cm	con top H - 33 1/4" with top	L - 90 cm	W - 35 1/2"	P - 45 cm	D - 17 3/4"

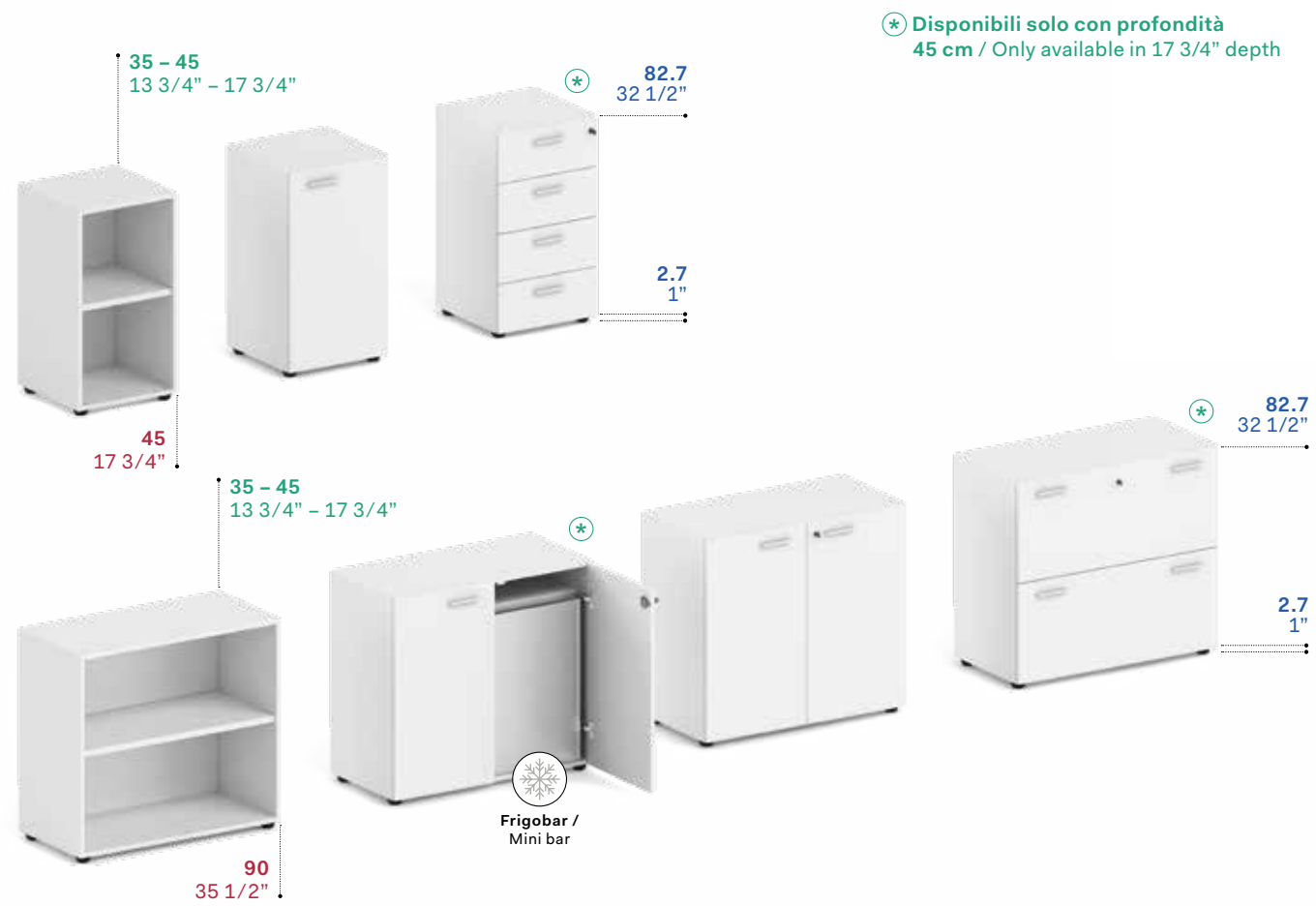

Note: I contenitori sono componibili, sovrapponibili (H max. 253 cm) e vanno completati con il top "obbligatorio" sp. 1.8 cm. Zoccoli "Optional". / Storage units can be combined, stacked (max. height: 99 1/2") and need to be completed with a 3/4" thick "compulsory" top. Base metal frames are Optional.

Abbinamenti ante e scocche / Door and body combinations

- Melaminico / Melamine
- Laminato / Laminate
- ⊕ Impiallacciato (su richiesta) / Veneered (on request)
- ▽ Vetro Acidato / Acetated Glass
- ⊖ Vetro Retrolaccato / Rear-lacquered Glass

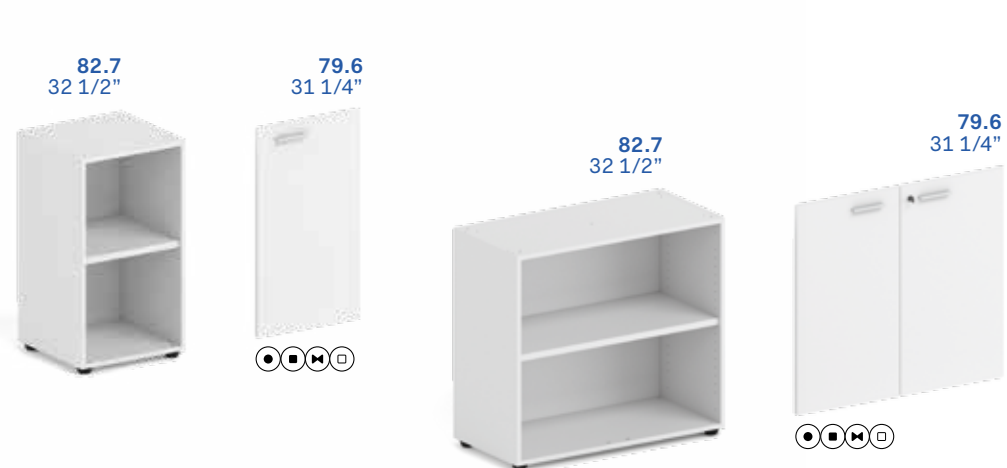

Configurazioni contenitori / Storage unit configurations



Altezza	Height	Larghezza	Width	Profondità	Depth
A - 127.5 cm	senza top H - 50 1/4" without top	L - 45 cm	W - 17 3/4"	P - 35 cm	D - 13 3/4"
A - 129.3 cm	con top H - 51" with top	L - 90 cm	W - 35 1/2"	P - 45 cm	D - 17 3/4"

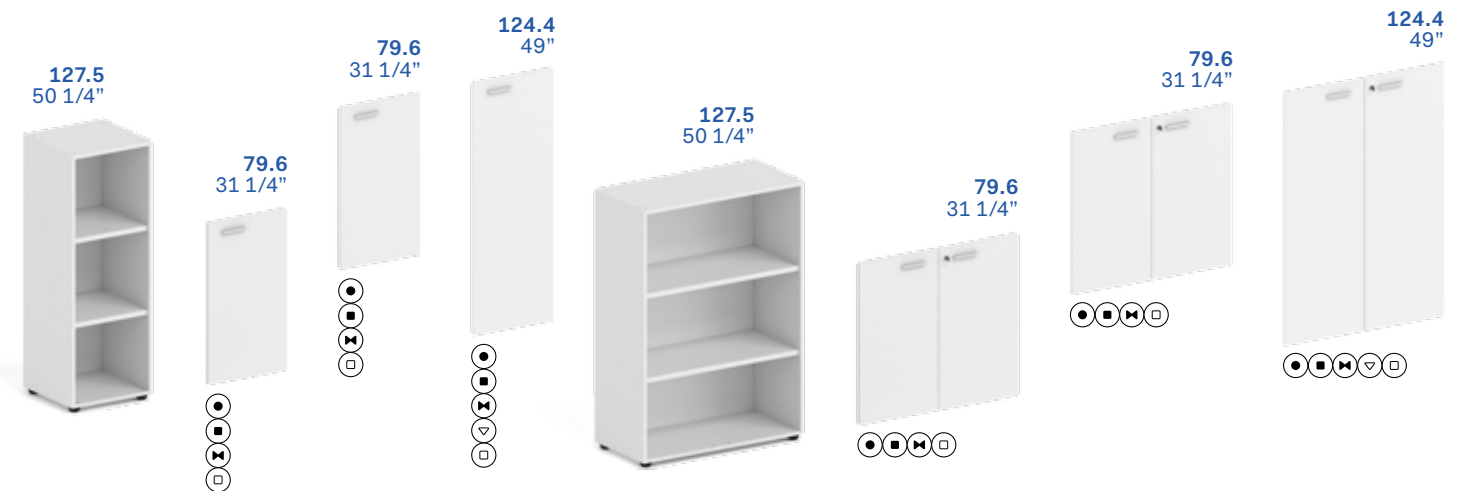

Abbinamenti ante e scocche / Door and body combinations



Configurazioni contenitori / Storage unit configurations

Altezza A - 162.7 cm senza top A - 164.5 cm con top	Height H - 64" without top H - 64 3/4" with top		Larghezza L - 45 cm	Width W - 17 3/4"		Profondità P - 35 cm P - 45 cm	Depth D - 13 3/4" D - 17 3/4"	
--	--	---	-------------------------------	-----------------------------	---	---	--	---



[Note:] I contenitori sono componibili, sovrapponibili (H max. 253 cm) e vanno completati con il top "obbligatorio" sp. 1.8 cm. Zoccoli "Optional". / Storage units can be combined, stacked (max. height: 99 2/4") and need to be completed with a 3/4" thick "compulsory" top. Base metal frames are Optional.

Abbinamenti ante e scocche / Door and body combinations

- Melaminico / Melamine
- Laminato / Laminate
- Impiallacciato (su richiesta) / Veneered (on request)
- Vetro Acidato / Acetated Glass
- Vetro Retrolaccato / Rear-lacquered Glass

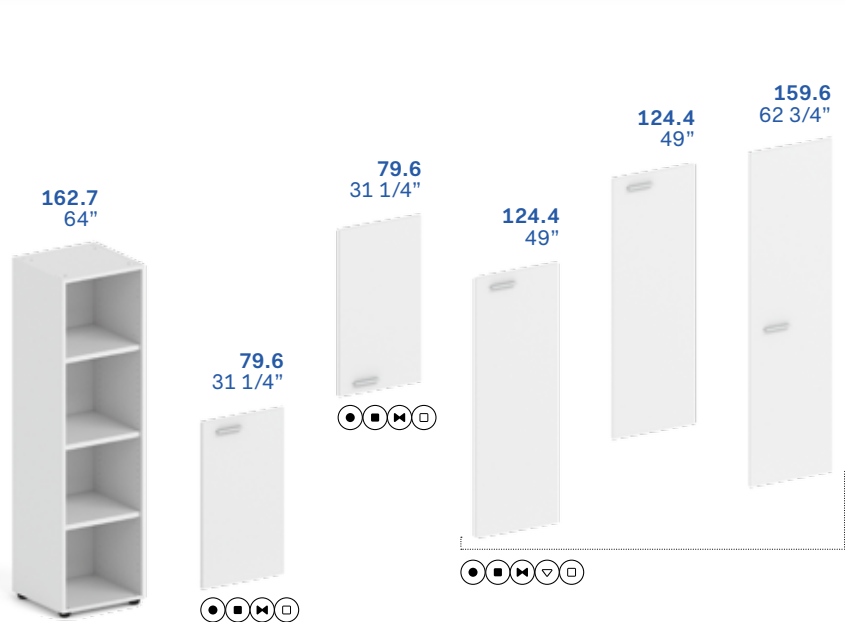

Configurazioni contenitori / Storage unit configurations

Altezza A - 162.7 cm senza top A - 164.5 cm con top	Height H - 64" without top H - 64 3/4" with top		Larghezza L - 90 cm	Width W - 35 1/2"		Profondità P - 35 cm P - 45 cm	Depth D - 13 3/4" D - 17 3/4"	
--	--	---	-------------------------------	-----------------------------	---	---	--	---



Abbinamenti ante e scocche / Door and body combinations

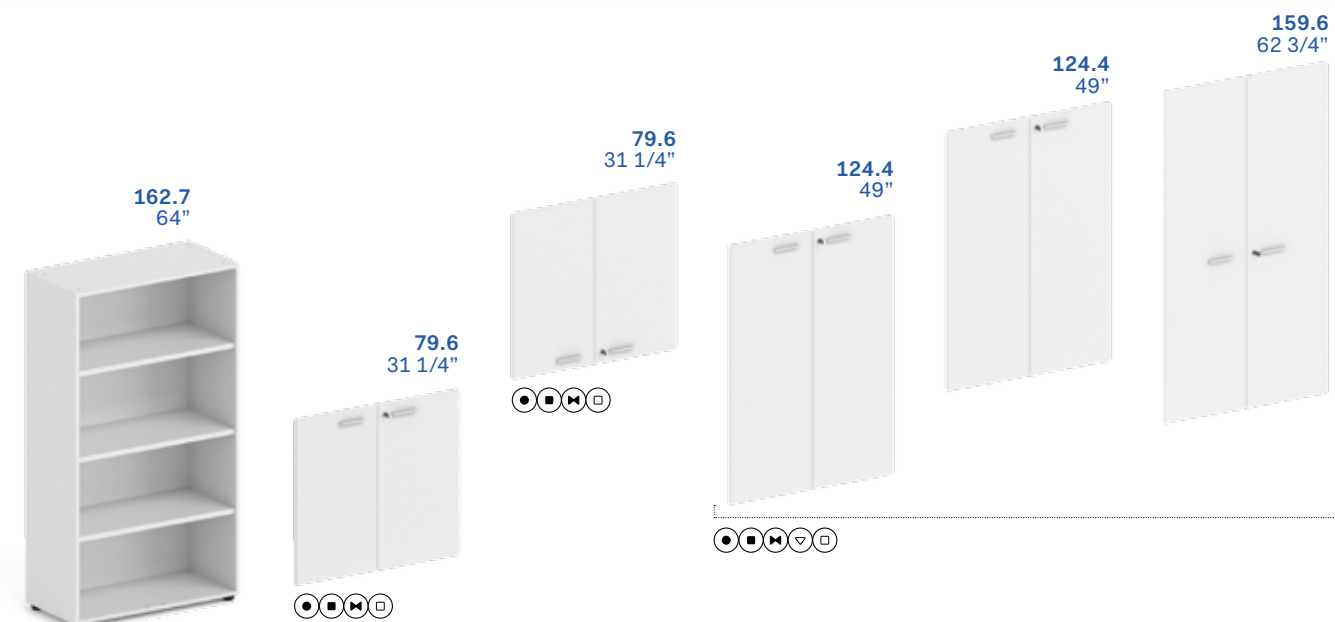

Configurazioni contenitori / Storage unit configurations

Altezza	Height	Larghezza	Width	Profondità	Depth
A - 207.5 cm senza top	H - 81 3/4" without top	L - 45 cm	W - 17 3/4"	P - 35 cm	D - 13 3/4"
A - 209.3 cm con top	H - 82 1/2" with top			P - 45 cm	D - 17 3/4"

* Disponibili solo con profondità 45 cm / Only available in 17 3/4" depth

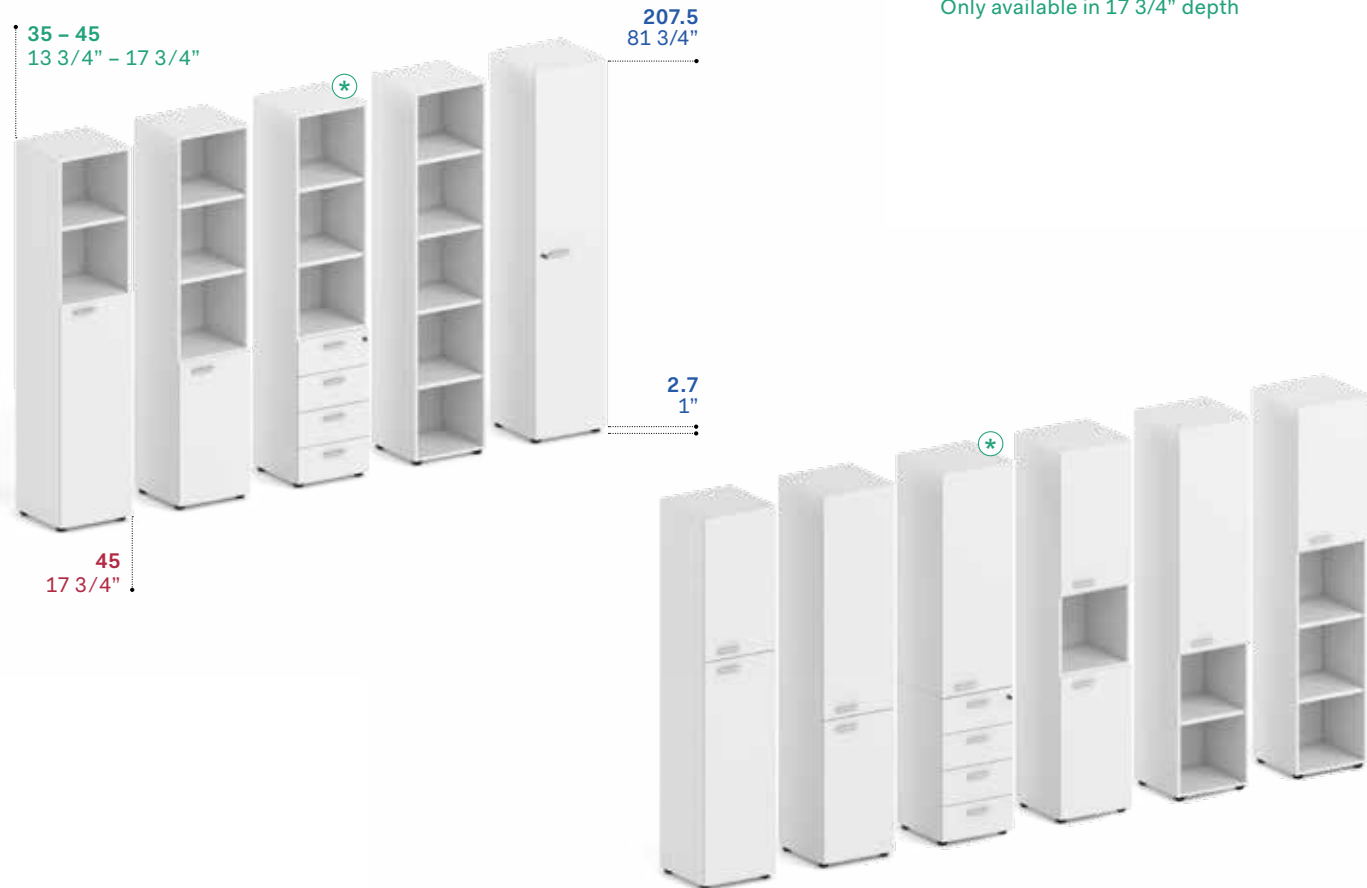

Note: I contenitori sono componibili, sovrapponibili (H max. 253 cm) e vanno completati con il top "obbligatorio" sp. 1.8 cm. Zoccoli "Optional". / Storage units can be combined, stacked (max. height: 99 2/4") and need to be completed with a 3/4" thick "compulsory" top. Base metal frames are Optional.

Abbinamenti ante e scocche / Door and body combinations

- Melaminico / Melamine
- Laminato / Laminate
- ◀ Impiallacciato (su richiesta) / Veneered (on request)
- ▽ Vetro Acidato / Acetated Glass
- Vetro Retrolaccato / Rear-lacquered Glass

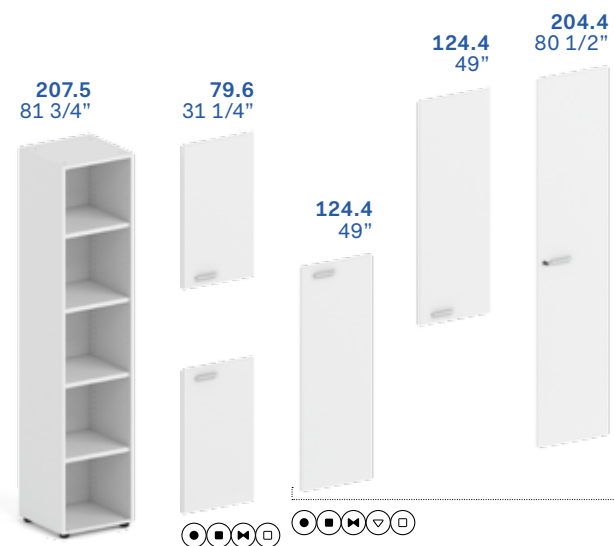

Configurazioni contenitori / Storage unit configurations

Altezza	Height	Larghezza	Width	Profondità	Depth
A - 207.5 cm senza top	H - 81 3/4" without top	L - 90 cm	W - 35 1/2"	P - 35 cm	D - 13 3/4"
A - 209.3 cm con top	H - 82 1/2" with top			P - 45 cm	D - 17 3/4"

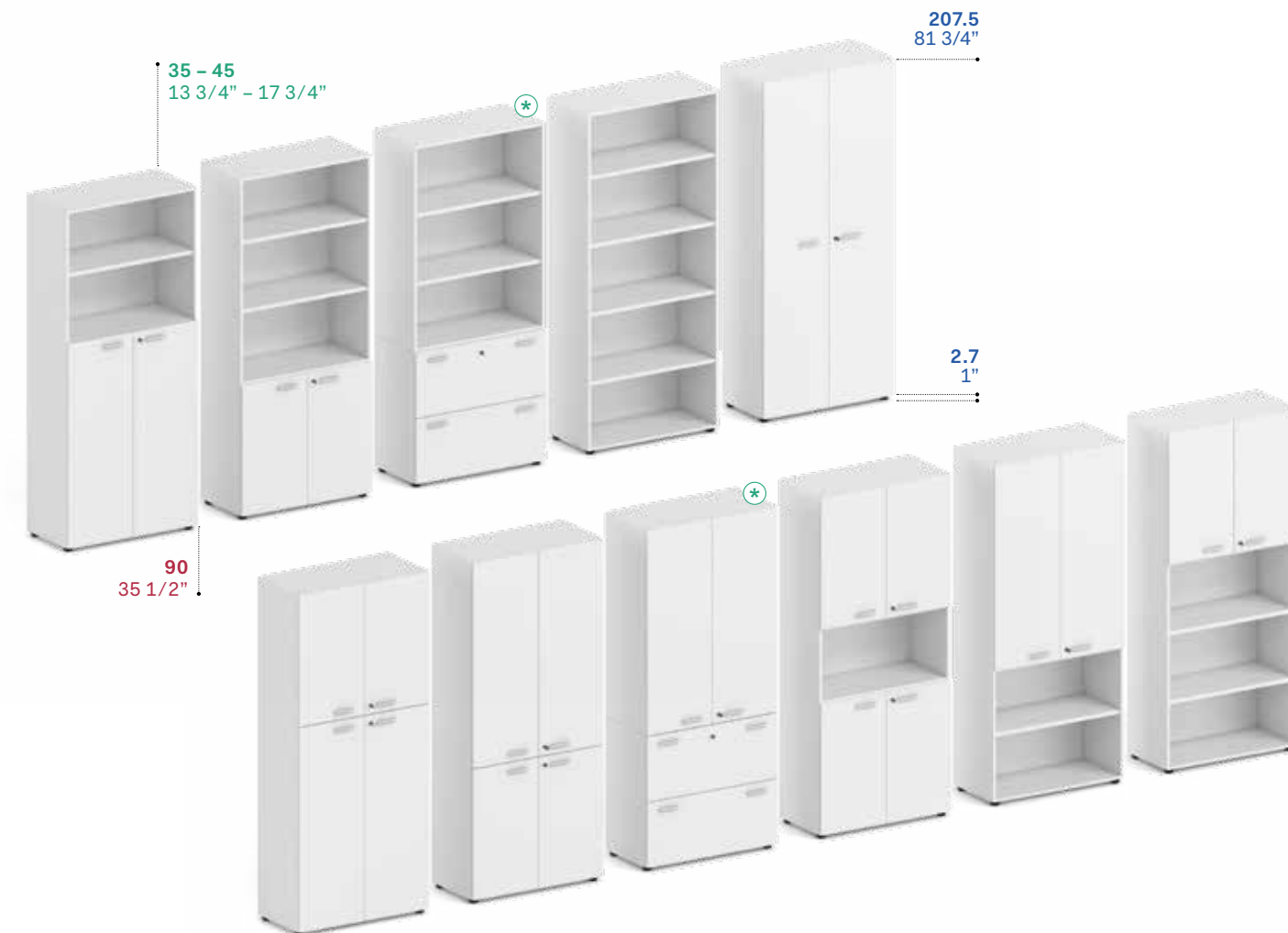

Abbinamenti ante e scocche / Door and body combinations

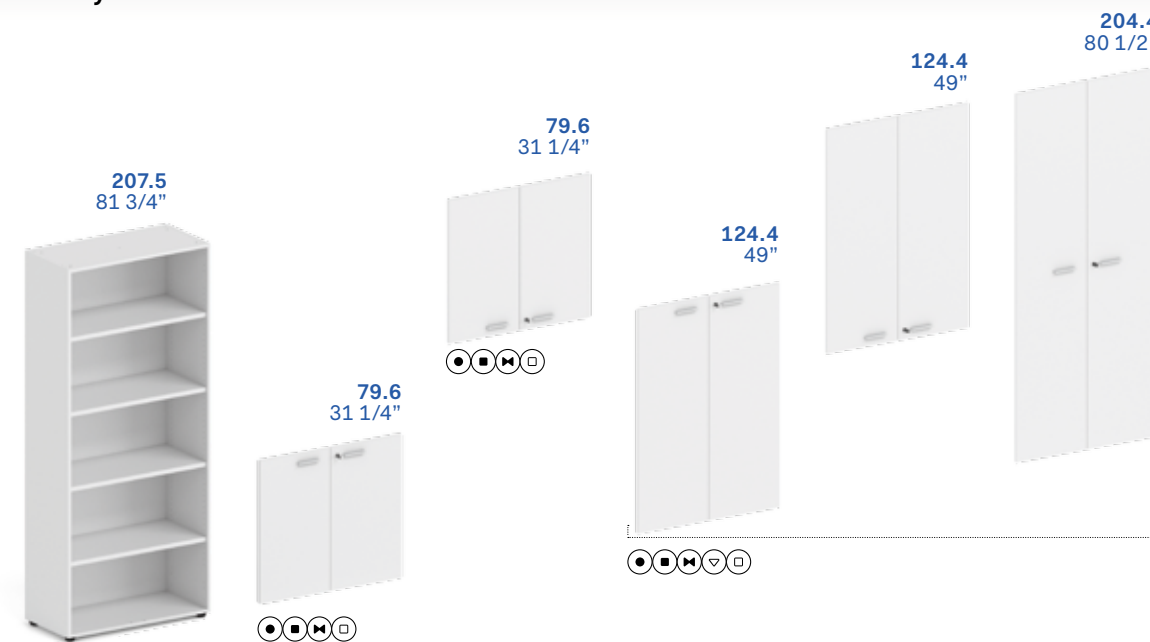

Capacità ripiani / Shelf storage capacity

L: 45 - W: 17 3/4"



4 Dox con ante /
Dox with doors

4 Dox a giorno /
Dox open

L: 90 - W: 35 1/2"

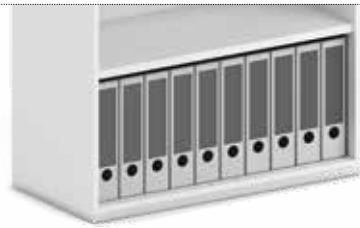

9 Dox con ante /
Dox with doors

10 Dox a giorno /
Dox open

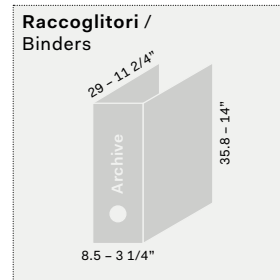

Raccoglitori /
Binders

L: 45 - W: 17 3/4"



23 Cartelle /
Folders

L: 90 - W: 35 1/2"



48 Cartelle /
Folders

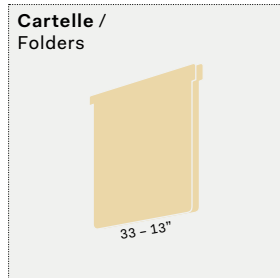

Cartelle /
Folders

Note: Possibilità di archiviazione cartelle sotto i ripiani metallici con profondità 45 cm. / Possibility to store the folders under the metal shelves with 17 3/4" depth.

Portata ripiani melaminico e metallo / Melamine and metal shelf carrying capacity

30 KG



L: 45 - W: 17 3/4"

40 KG



Portata ripiani L: 45 cm in melaminico: 30 kg /
W: 17 3/4" melamine shelf carrying capacity 66 lbs



Portata ripiani L: 45 cm in metallo: 40 kg /
W: 17 3/4" metal shelf carrying capacity 88 lbs

30 KG



L: 90 - W: 35 1/2"

40 KG



Portata ripiani L: 90 cm in melaminico: 30 kg /
W: 35 1/2" melamine shelf carrying capacity 66 lbs



Portata ripiani L: 90 in Metallo: 40 kg /
W: 35 1/2" Metal shelf carrying capacity 88 lbs

Portata max di ogni contenitore: 200 kg /
Maximum carrying capacity of each storage unit is 441 lbs

Portata massima dei ripiani con carico uniformemente distribuito / Shelf maximum static load with uniformly distributed weight

Capacità contenitiva - contenitori con ante / Storage capacity - storage units with doors

209.3
82 1/2"



20 Dox
L: 45 - W: 17 3/4"

45 Dox
L: 90 - W: 35 1/2"

164.5
64 3/4"



16 Dox
L: 45 - W: 17 3/4"

36 Dox
L: 90 - W: 35 1/2"

129.3
51"



12 Dox
L: 45 - W: 17 3/4"

27 Dox
L: 90 - W: 35 1/2"

84.5
33 1/4"



8 Dox
L: 45 - W: 17 3/4"

18 Dox
L: 90 - W: 35 1/2"

Capacità contenitiva - contenitori a giorno / Storage capacity - open storage units

209.3
82 2/4"



20 Dox
L: 45 - W: 17 3/4"

50 Dox
L: 90 - W: 35 1/2"

164.5
64 3/4"



16 Dox
L: 45 - W: 17 3/4"

40 Dox
L: 90 - W: 35 1/2"

129.3
51"



12 Dox
L: 45 - W: 17 3/4"

30 Dox
L: 90 - W: 35 1/2"

84.5
33 1/4"



8 Dox
L: 45 - W: 17 3/4"

20 Dox
L: 90 - W: 35 1/2"

Note: Le quantità riportate si riferiscono alla capienza del contenitore indicato. / The listed quantities refer to the total storage capacity of the shown unit.

Capacità telai portacartelle e classificatori / Filing drawers storage capacity

Larghezza	Width	Profondità	Depth
L - 45 cm	W - 17 3/4"	P - 45 cm	D - 17 3/4"
L - 90 cm	W - 35 1/2"		

* Box metallici "Optional" solo L: 90 cm / "Optional" metal boxes only W: 35 2/4" available

L: 45 - W: 17 3/4"



23 Cartelle / Folders

L: 90 - W: 35 1/2"

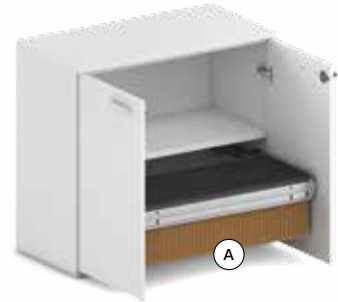

50 Cartelle / Folders

L: 90 - W: 35 1/2"



L: 90 - W: 35 1/2"

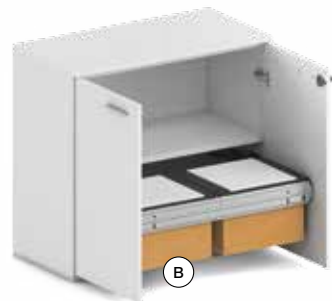

40 Cartelle / Folders

Soluzione con box metallico / Solution with metal box

L: 90 - W: 35 1/2"



L: 90 - W: 35 1/2"



50 Cartelle / Folders

40 Cartelle / Folders



Soluzione con box metallico / Solution with metal box



Appendiabiti / Wardrobes

L: 45 cm - 90 cm con asta portabiti scorrevole / W: 17 3/4" - 35 1/2" with sliding hanger bar

Frigobar / Mini bar

Frigobar incassato, capienza 50 litri, 70 Watt, 220-230 Volt / Built-in mini-bar fridge, 50 lt capacity, 70 Watt, 220-230 Volt



45 17 3/4"

209.3 82 1/2"



90 35 1/2"



84.5 33 1/4"

90 35 1/2"

Contenitori H: 74 cm / H: 29 1/4" high storage

Contenitore complanare P 35 x L 80 x H 74 cm con ante. Top sp. 1.8-2.5 cm - obbligatorio, zoccolo (Optional) / D 13 3/4" x W 31 1/2" x H 29 1/4" cm coplanar storage unit with doors. Tops 3/4"-1" thick required, baseframe (Optional)

Contenitore complanare P 35 x L 80 x H 74 cm a giorno. Top sp. 1.8-2.5 cm obbligatorio, zoccolo (Optional) / D 13 3/4" x W 31 1/2" x H 29 1/4" open coplanar storage unit. Tops 3/4"-1" thick required, baseframe (Optional)

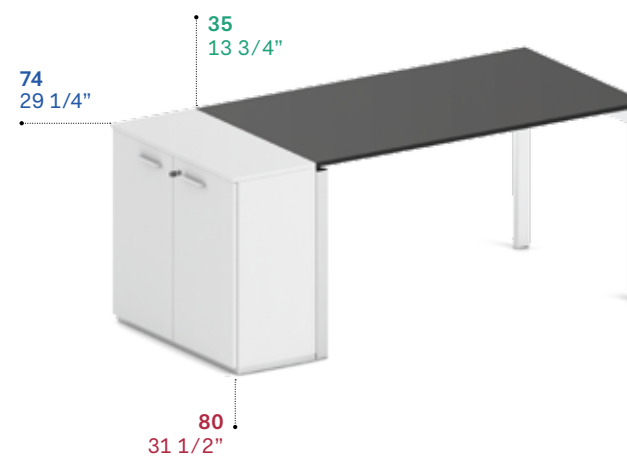

80 31 1/2"

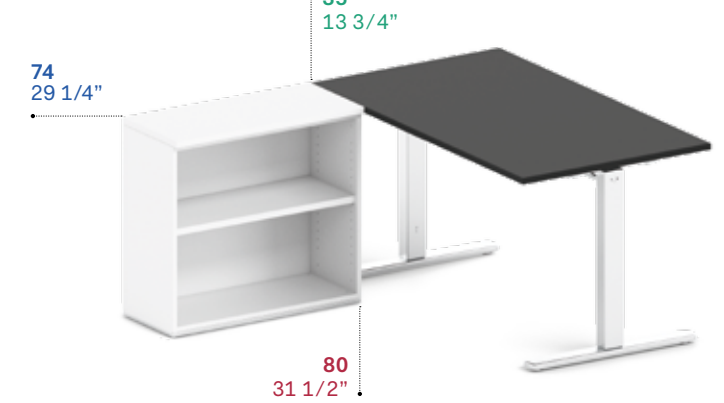

80 31 1/2"

[Note:] Per le relative finiture degli appendiabiti, del frigobar e dei contenitori complanari H.74, consultare il Listino Prezzi. / For the relative finishes of the wardrobes, the minibar fridge and the H. 29 1/4" coplanar storages unit, consult the Price List.

Schema compositivo / Configuration scheme

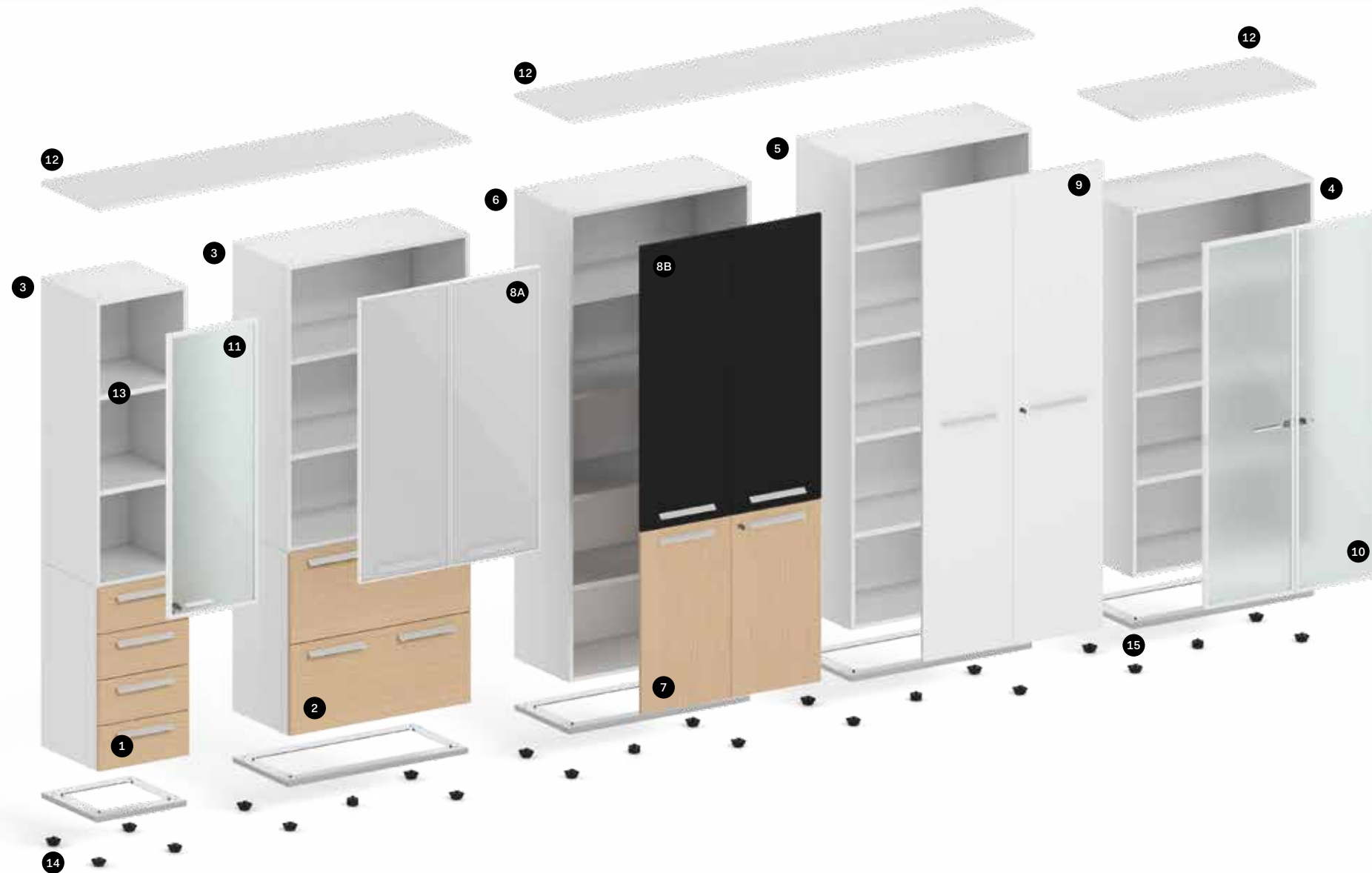

- 1** Contenitore 4 cassetti
H. 82.7 cm /
4 drawers storage unit
H. 32 1/2"
- 2** Contenitore classificatore
H. 82.7 cm /
Filing drawer unit H. 32 1/2"
- 3** Contenitore a giorno
H. 127.5 cm /
Open storage unit H. 50 1/4"
- 4** Contenitore a giorno
H. 162.7 cm /
Open storage unit H. 64"
- 5** Contenitore a giorno
H. 207.5 cm /
Open storage unit H. 81 3/4"
- 6** Contenitore a giorno
H. 207.5 cm per ante
sovrapposte o parziali /
Open storage unit H. 81 3/4 for
overlapped or partial doors
- 7** Ante piene
H. 79.6 cm /
Wooden doors H. 31 1/4"
- 8A** Ante H. 124.4 cm
vetro retrolaccato con
telaio / Rear-lacquered
glass doors with aluminium
frame H. 49"
- 8B** Ante piene
H. 124.4 cm /
Melamine doors H. 49"
- 9** Ante piene
H. 204.4 cm /
Wooden doors H 80 1/2"
- 10** Anta H. 159.6 cm
vetro acidato con telaio /
Acetated glass doors
with aluminium frame
H. 62 3/4"
- 11** Anta H. 124.4 cm
vetro acidato con telaio /
Acetated glass door
with aluminium frame H. 49"
- 12** Top "obbligatorio" sp. 1.8 cm /
"Compulsory" top 3/4" thick
- 13** Ripiano posizionabile in
melaminico o metallo
sp. 2.5 cm /
Melamine or metal height
adjustable shelf 1" thick
- 14** Piedini regolabili
sp. 2.7 cm / Adjustable
feet 1" thick
- 15** Zoccolo metallico
"Optional" sp. 2.7 cm /
"Optional" base metal
frame 1" thick

Dimensioni componenti / Component dimensions

Top "obbligatorio" sp. 1.8 cm /
"Compulsory" top 3/4" thick

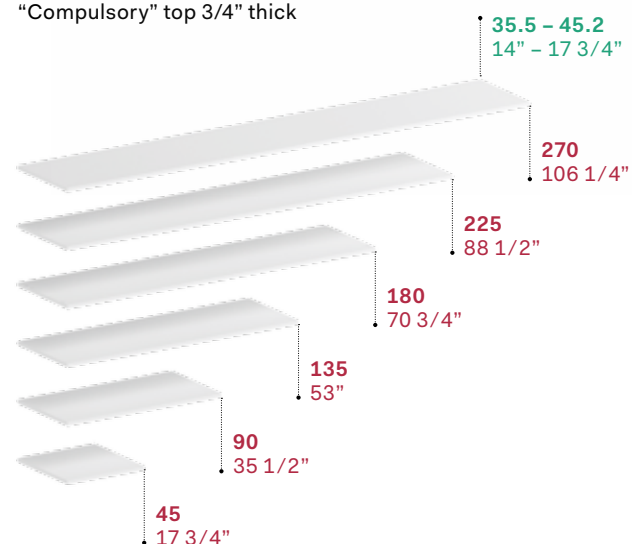

Zoccoli metallici "Optional" /
"Optional" metal base frames

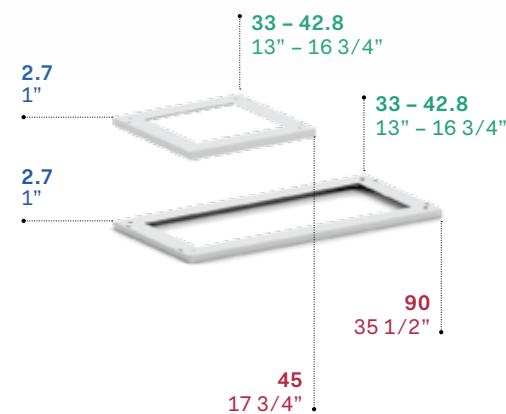

Fianchi terminali / Terminal side panels

Per l'utilizzo dei fianchi terminali abbinare sempre top "standard" / Always use "standard" tops with the terminal side panels

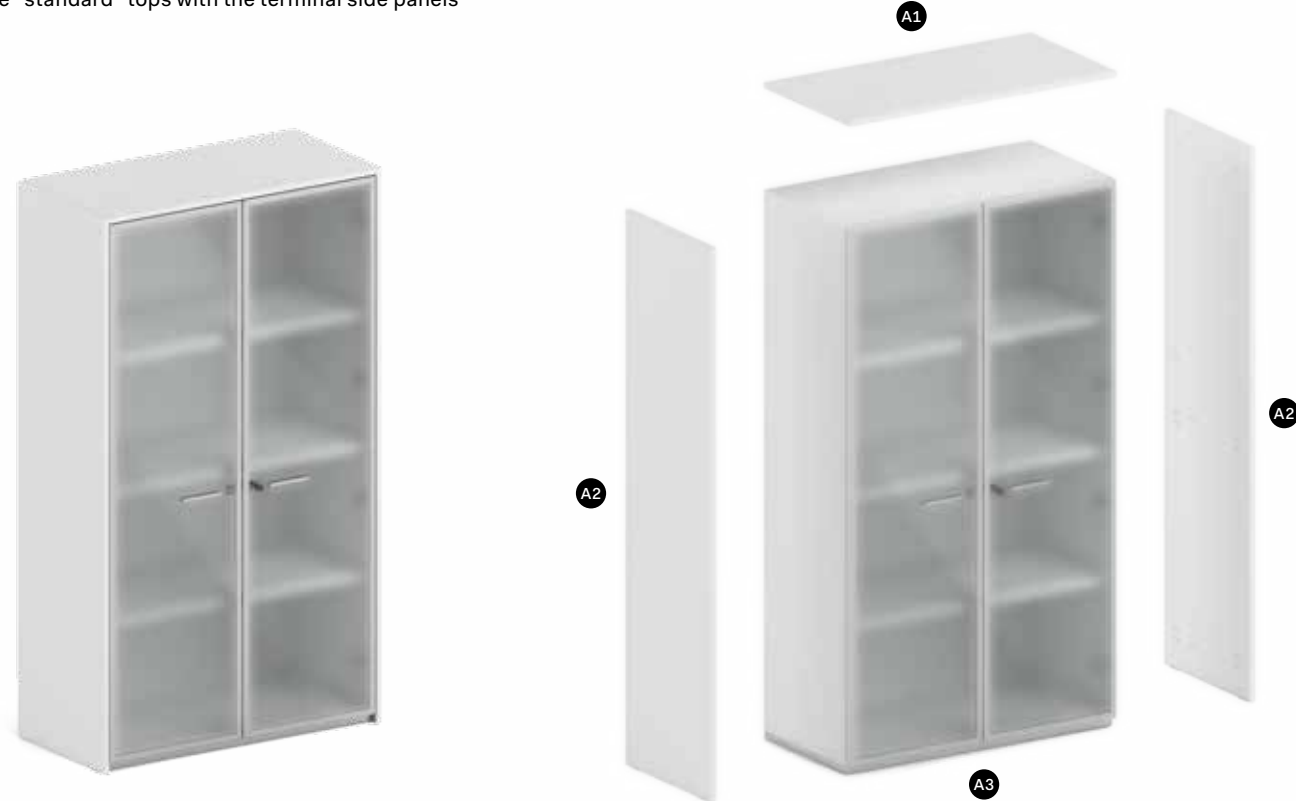

A1
Top "standard": sp. 1.8 cm / "Standard" top: 3/4" thick

A2
Fianco terminale: sp. 1.8 cm / Terminal side panel: 3/4" thick

A3
Contenitore / Storage unit

Schiena di finitura da utilizzare solo per scocche profondità 45 cm / Finishing back panels, to be used only with 17 3/4" deep units

Per l'utilizzo della schiena di finitura abbinare sempre top "bifacciali" / Always use "bifacial" tops when using a finishing back panel

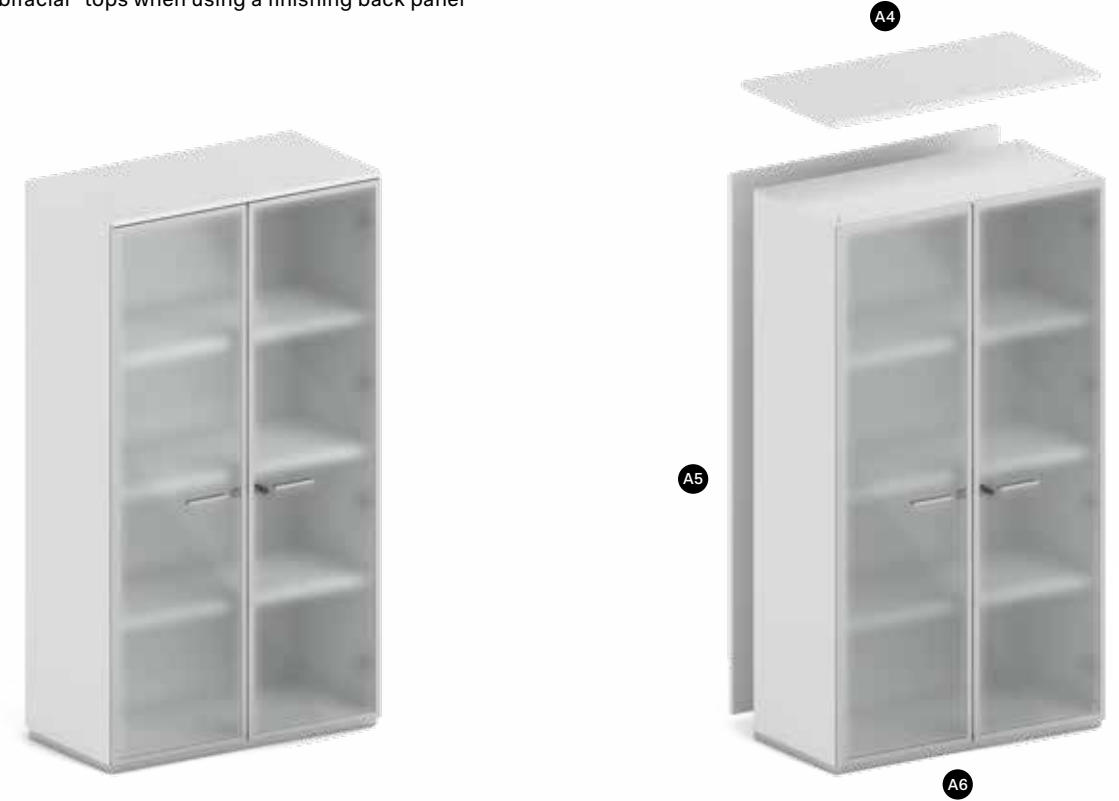

A4
Top "bifacciale": sp. 1.8 cm / "Bifacial" top: 3/4" thick

A5
Schiena di finitura: sp. 1.8 cm / Finishing back panel: 3/4" thick

A6
Contenitore / Storage unit

Dimensioni componenti / Component dimensions

Coppia di fianchi terminali: sp. 1.8 cm / Pair of terminal side panels: 3/4" thick

Top "standard": sp. 1.8 cm / "Standard" tops: 3/4" thick

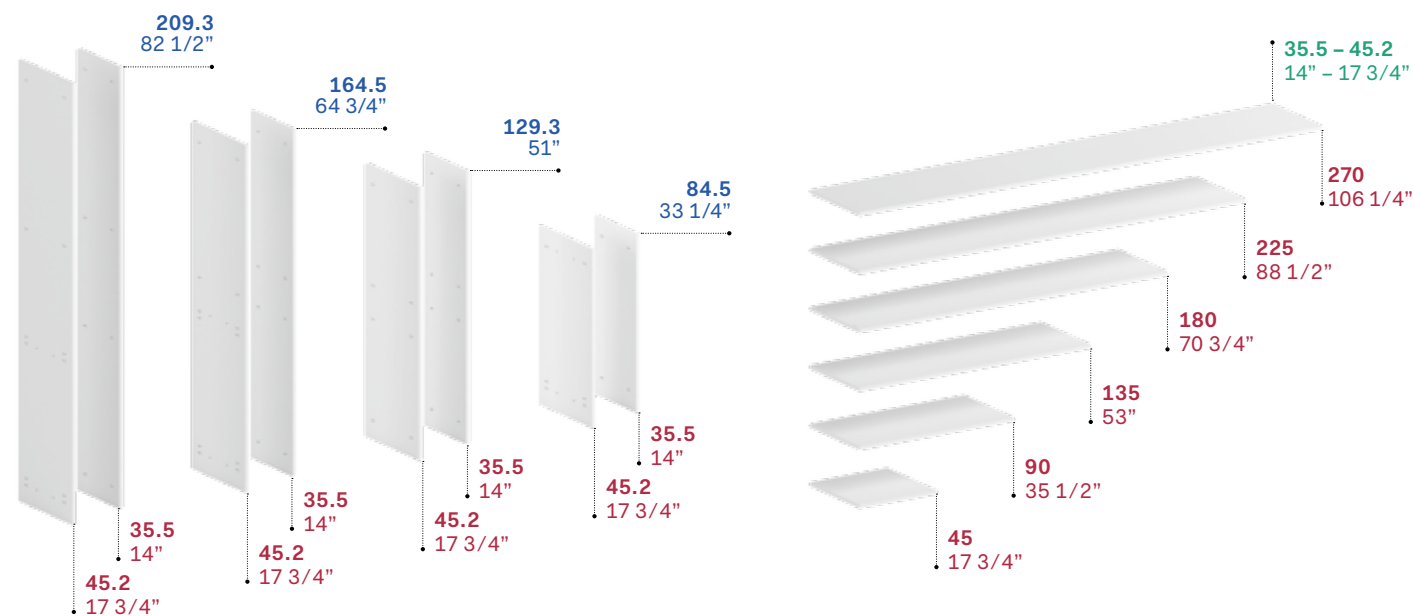

Dimensioni componenti / Component dimensions

Schiena di finitura: sp. 1.8 cm / Finishing back panels: 3/4" thick

Top "bifacciali": sp. 1.8 cm / Top "bifacciali": 3/4" thick

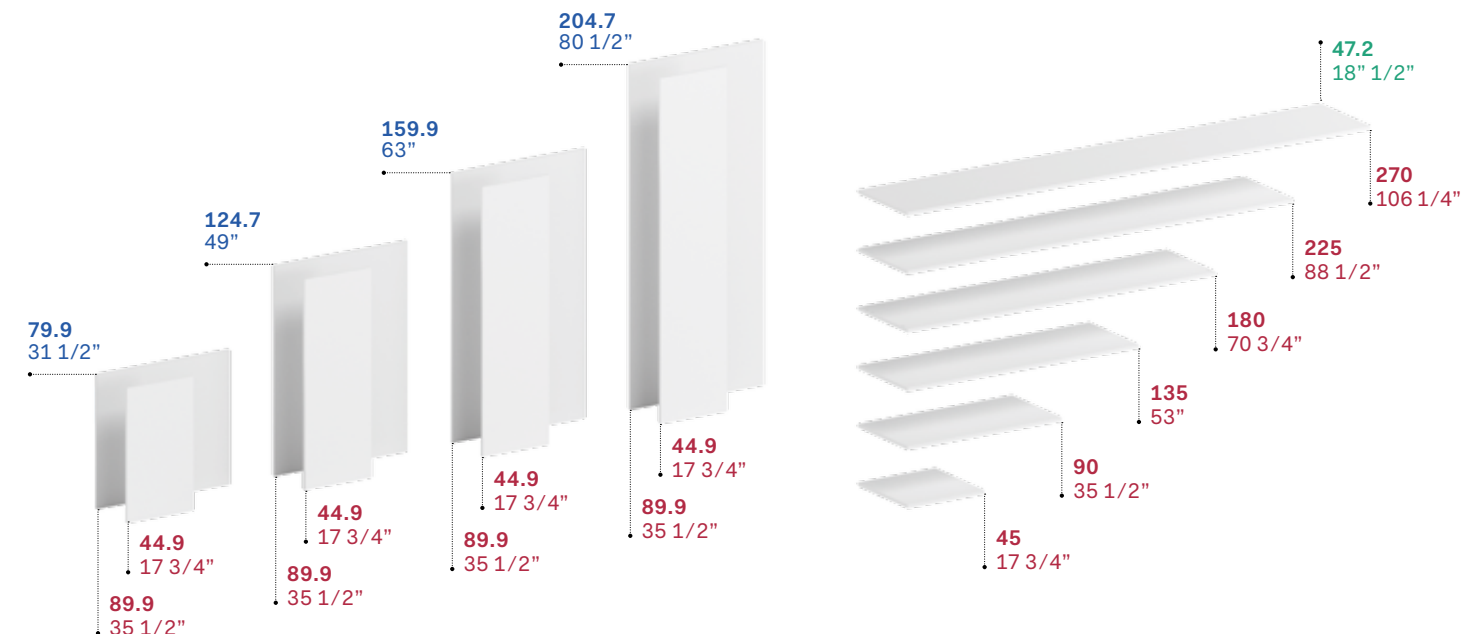

Accessori per contenitori – cassettiere /
Accessories for storage units – pedestals



Portacartelle estraibile per contenitore /
Draw-out frame for folders for storage



Ripiano in metallo predisposto per cartelle
sospese / Metal shelf designed for hanging files



Contenitore con frigo-bar capacità 50 lt /
Storage unit with mini-bar, capacity 50 litres



Box metallico L: 90 cm per cassetto
classificatore e portacartelle estraibile /
W: 35 2/4" metal box for filing drawer and
draw-out folder frame

Chiavi /
Keys



Serrature di serie ante vetro acidato /
Standard lock on acetated glass doors



Chiave passepartout (Optional) /
Master key (Optional)



Serrature di serie ante-cassetti /
Standard locks doors and drawer fronts



Chiave estrazione cilindro (Optional) /
Pull-out cylinder key (Optional)

Maniglie /
Handles



Interasse 96 mm /
96 mm Centers



Interasse 96 mm /
96 mm Centers



Interasse 256 mm /
256 mm Centers



Interasse 256 mm /
256 mm Centers

Contenitori / Storage units

Scocca sp. 1.8 cm, in melaminico / Body 1.8 cm thick, in melamine

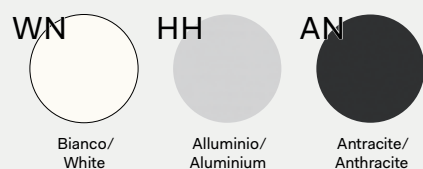

Ripiani sp. 2.5 cm, in melaminico o metallo / Shelves 2.5 cm thick, in melamine or metal

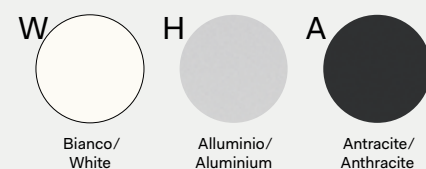

Ante e frontali cassetto sp. 1.8 cm, in melaminico (*) o laminato (**)/ Doors and drawer fronts 1.8 cm thick, in melamine (*) or laminate (**)



Ante sp. 0.4 cm, in vetro temprato con telaio in alluminio anodizzato sp. 2 cm (H 124.4/159.6/204.4 cm) / Doors 0.4 cm thick, tempered glass with anodized aluminium frame 2 cm thick (H 124.4/159.6/204.4 cm thick)

Ante sp. 0.4 cm, in vetro temprato con telaio in alluminio anodizzato sp. 2 cm (H 79.6/124.4/159.6/204.4 cm) / Doors 0.4 cm thick, tempered glass with anodized aluminium frame 2 cm thick (H 79.6/124.4/159.6/204.4 cm thick)

Ante, frontali cassetto, Top, fianchi e schiene di finitura sp. 1.8 cm, in impiallacciato / Doors, drawer fronts, Top, decorative side and back panels 1.8 cm thick, veneered



Fianchi di finitura sp. 1.8 cm, in melaminico (*) o laminato (**)/ Decorative side 1.8 cm thick, in melamine (*) or laminate (**)

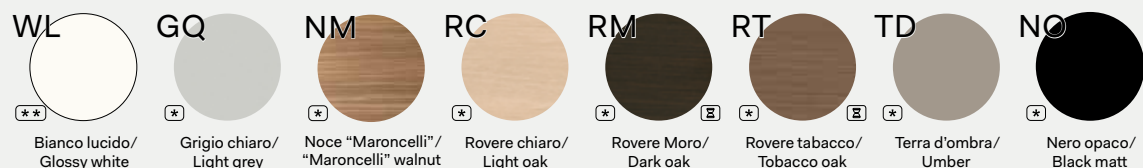

Top e schiene sp. 1.8 cm, in melaminico (*) o laminato (**)/ Top and backs 1.8 cm thick, in melamine (*) or laminate (**)



Maniglie / Handles

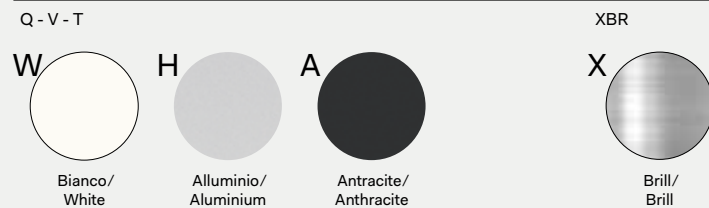

Note

■ Prodotti non in pronta consegna. Per la disponibilità contattare l'ufficio commerciale / Items not in prompt delivery. Please contact the commercial department to check availability.

☒ Fino ad esaurimento. / Until exhaustion.

Contenitori universali / Universal storage units

L 45 x H 82,7



L 90 x H 82,7



L 45 x H 127,5



L 90 x H 127,5

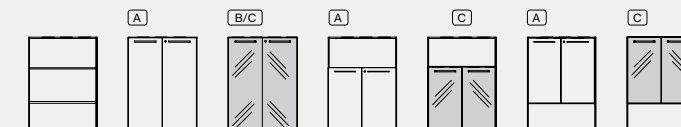

L 45 x H 162,7



L 90 x H 162,7

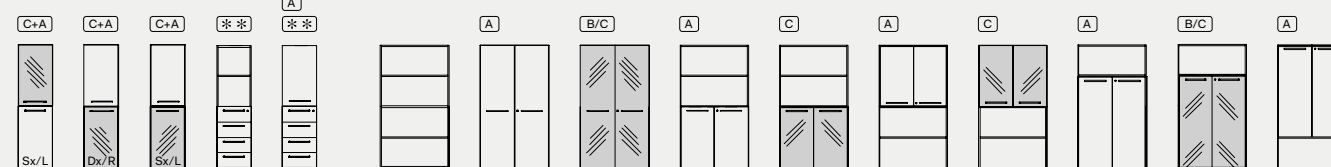

Note:

Tipologie ante vetro disponibili / Available glass doors

- A Ante in melaminico / Wooden door;
- B Ante vetro acidato con telaio in alluminio dotata di serratura / Acidated glass door with aluminium frame and lock;
- C Ante vetro retrolaccato con telaio in alluminio / Rear-lacquered glass door with aluminium frame;

I contenitori P 35 cm sono disponibili solo con ripiani in melaminico / 35 cm deep storage units are available only with melamine shelves;

- ☒ Contenitori attrezzati disponibili solo P 45 cm / Storage units with accessories only available in 45 cm depth;
- * Contenitori disponibili solo P 45 cm / Storage units available only in 45 cm depth;
- ** Contenitori sovrapposti disponibili solo P 45 cm / Stackable storage units only available in 45 cm depth;

L 90 x H 162,7

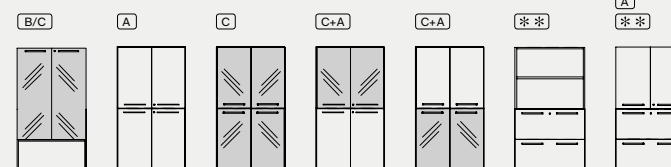

L 45 x H 207,5

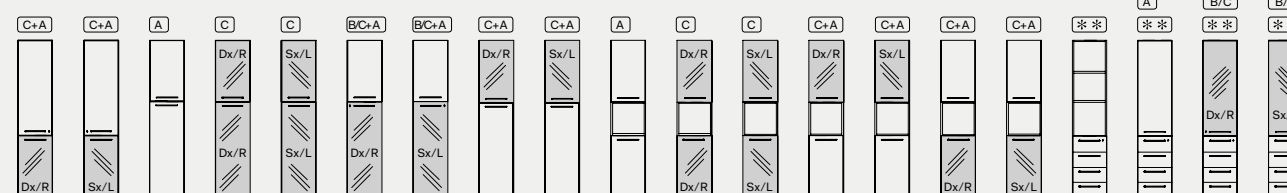
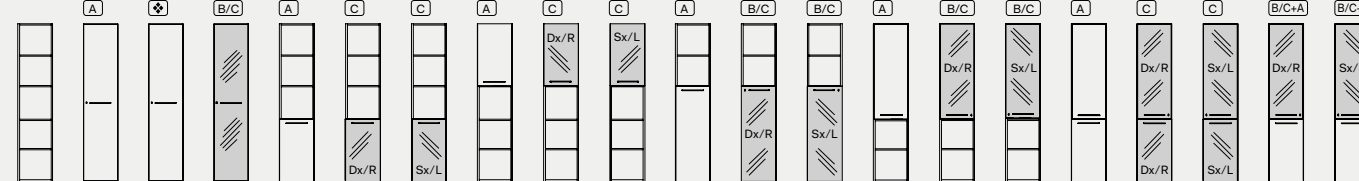

L 90 x H 207,5

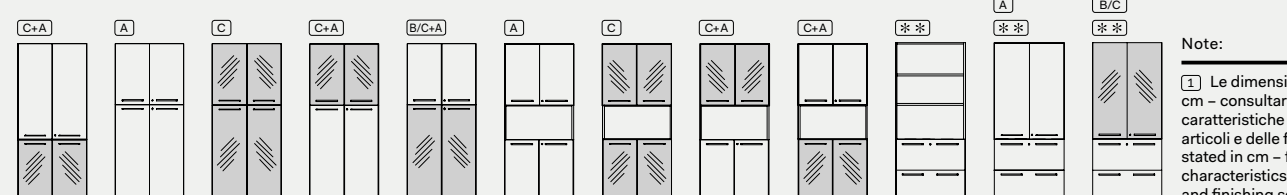
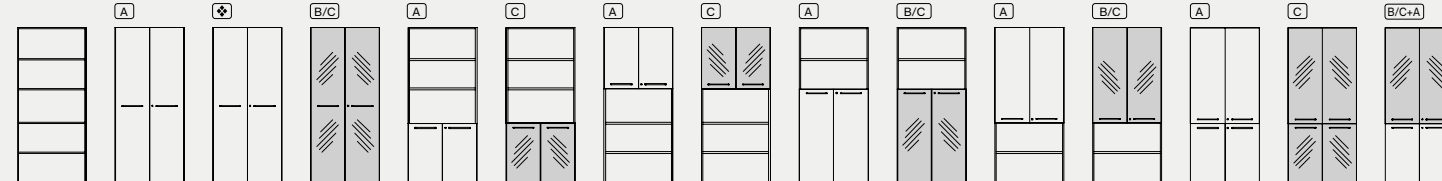

Note:

1 Le dimensioni sono espresse in cm - consultare il listino prezzi per le caratteristiche tecniche, i codici degli articoli e delle finiture / Dimensions are stated in cm - for technical characteristics, article code numbers and finishing see price list.

Contenitori a giorno/Open storage units

L 45 x H 82,7	L 90 x H 82,7	<p>Note:</p> <p>503...A...P 33,2 / 503...B...P 43: Ripiano in melaminico/Melamine shelf 503...M...P 43: Ripiano in metallo/Metal shelf</p> <p>Tipologie maniglie disponibili / Available handle typologies</p> <p>Maniglia "Q" e "XBR" utilizzabile solo con ante piene o ante in vetro acidate / Handle "Q" e "XBR" to be used only with wooden doors or acetated glass door</p>			
503.CU.GA.08.11_P 33,2 503.CU.GB.08.11_P 43 503.CU.GM.08.11_P 43	503.CU.GA.08.21_P 33,2 503.CU.GB.08.21_P 43 503.CU.GM.08.21_P 43				
L 45 x H 127,5	L 90 x H 127,5	L 45 x H 127,5	L 90 x H 127,5		
503.CU.GA.12.11_P 33,2 503.CU.GB.12.11_P 43 503.CU.GM.12.11_P 43	503.CU.GA.12.21_P 33,2 503.CU.GB.12.21_P 43 503.CU.GM.12.21_P 43	503.CU.SA.12.11_P 33,2 503.CU.SB.12.11_P 43 503.CU.SM.12.11_P 43	503.CU.SA.12.21_P 33,2 503.CU.SB.12.21_P 43 503.CU.SM.12.21_P 43		
L 45 x H 162,7	L 45 x H 162,7	L 90 x H 162,7	L 90 x H 162,7	L 90 x H 162,7	
503.CU.GA.16.11_P 33,2 503.CU.GB.16.11_P 43 503.CU.GM.16.11_P 43	503.CU.SA.16.11_P 33,2 503.CU.SB.16.11_P 43 503.CU.SM.16.11_P 43	503.CU.GA.16.21_P 33,2 503.CU.GB.16.21_P 43 503.CU.GM.16.21_P 43	503.CU.SA.16.21_P 33,2 503.CU.SB.16.21_P 43 503.CU.SM.16.21_P 43	503.CU.EA.16.21_P 33,2 503.CU.EB.16.21_P 43 503.CU.EM.16.21_P 43	Per ante sovrapposte o parziali /For overlapped or partial doors
L 45 x H 207,5	L 45 x H 207,5	L 45 x H 207,5	L 90 x H 207,5	L 90 x H 207,5	L 90 x H 207,5
503.CU.GA.20.11_P 33,2 503.CU.GB.20.11_P 43 503.CU.GM.20.11_P 43	503.CU.SA.20.11_P 33,2 503.CU.SB.20.11_P 43 503.CU.SM.20.11_P 43	503.CU.NA.20.11_P 33,2 503.CU.NB.20.11_P 43 503.CU.NM.20.11_P 43	503.CU.GA.20.21_P 33,2 503.CU.GB.20.21_P 43 503.CU.GM.20.21_P 43	503.CU.EA.16.21_P 33,2 503.CU.EB.16.21_P 43 503.CU.EM.16.21_P 43	503.CU.NA.20.21_P 33,2 503.CU.NB.20.21_P 43 503.CU.NM.20.21_P 43

Contenitori attrezzati/Storage units with accessories

L 45 P 45 x H 82,7	L 90 P 45 x H 82,7	L 90 P 45 x H 82,7	L 90 P 45 x H 82,7	L 90 P 45 x H 82,7	L 90 P 45 x H 82,7	L 45 P 45 x H 207,5	L 90 P 45 x H 207,5
503.CU.C0.08_	503.CU.L0.08_	503.CU.F0.08_	503.CU.F0.09_	503.CU.F0.10_	503.CU.ZF.09_	503.CU.P0.20.11_	503.CU.P0.20.21_
						<p>Zoccolo metallico per contenitore basso con frigo bar / Base metal frame for unit with wooden doors and mini-bar</p>	

Ante piene [A]/Wooden doors [A]

L 44,7 P 1,8 x H 79,6	L 89,6 P 1,8 x H 79,6	L 89,6 P 1,8 x H 79,6	L 44,7 P 1,8 x H 124,4	L 89,6 P 1,8 x H 124,4	L 89,6 P 1,8 x H 124,4
503.CA.10.08_	503.CA.20.08_	503.CA.30.08_	503.CA.10.12_	503.CA.20.12_	503.CA.30.12_
L 44,7 - P 1,8 - H 159,6	L 89,6 - P 1,8 - H 159,6	L 44,7 - P 1,8 - H 204,4		L 89,6 - P 1,8 - H 204,4	
503.CA.10.15_	503.CA.20.15_	503.CA.10.20_	503.CA.20.20_		

Composizioni contenitori con ante in melaminico / Composition with storage units with wooden doors

L 45 P 35 x H 82,7	L 45 P 45 x H 82,7	L 90 P 35 x H 82,7	L 90 P 45 x H 82,7	<p>Note:</p> <p>503...A...P 33,2 / 503...B...P 43: Ripiano in melaminico/Melamine shelf 503...M...P 43: Ripiano in metallo/Metal shelf</p> <p>Tipologie maniglie disponibili / Available handle typologies</p> <p>Maniglia "Q" e "XBR" utilizzabile solo con ante piene o ante in vetro acidate / Handle "Q" e "XBR" to be used only with wooden doors or acetated glass door</p>			
503.CC.A0.01_	503.CC.B0.01_	503.CC.A0.02_	503.CC.B0.02_				
L 45 P 35 x H 127,5	L 45 P 45 x H 127,5	L 90 P 35 x H 127,5	L 90 P 45 x H 127,5				
503.CC.A0.03_	503.CC.B0.03_	503.CC.A0.04_	503.CC.B0.04_				
L 45 P 35 x H 162,7	L 45 P 45 x H 162,7	L 90 P 35 x H 162,7	L 90 P 45 x H 162,7				
503.CC.A0.05_	503.CC.B0.05_	503.CC.A0.06_	503.CC.B0.06_				
L 45 P 35 x H 207,5	L 45 P 45 x H 207,5	L 90 P 35 x H 207,5	L 90 P 45 x H 207,5				
503.CC.A0.07_	503.CC.B0.07_	503.CC.A0.08_	503.CC.B0.08_				
L 45 P 35 x H 207,5	L 45 P 45 x H 207,5	L 90 P 35 x H 207,5	L 90 P 45 x H 207,5				
503.CC.A0.09_	503.CC.B0.09_	503.CC.A0.10_	503.CC.B0.10_				

Ante in vetro acidato con telaio in alluminio anodizzato [B]/Acetated glass doors with anodised aluminium frame [B]

L 44,7 P 2 x H 124,4	L 89,6 P 2 x H 124,4	L 44,7 P 2 x H 159,6	L 89,6 P 2 x H 159,6	L 44,7 P 2 x H 204,4	L 89,6 P 2 x H 204,4
503.CV.10.12_	503.CV.20.12_	503.CV.10.15_	503.CV.20.15_	503.CV.10.20_	503.CV.20.20_
Dx/R - Sx/L		Dx/R - Sx/L		Dx/R - Sx/L	

Note:

- [1] Le dimensioni sono espresse in cm - consultare il listino prezzi per le caratteristiche tecniche, i codici degli articoli e delle finiture / Dimensions are stated in cm - for technical characteristics, article code numbers and finishing see price list;
- [2] La finitura impiallacciato non è in pronta consegna. Per la disponibilità contattare l'ufficio commerciale / Veneered finish is not in prompt delivery. Please contact the commercial department to check availability;
- [F] Prodotti non in pronta consegna. Per la disponibilità contattare l'ufficio commerciale / Items not in prompt delivery. Please contact the commercial department to check availability;
- [M] Con serratura / With lock;
- [F] Frigo-bar / Mini-bar.

Ante in vetro retrolaccato con telaio in alluminio anodizzato ☐ / Rear lacquered glass doors with anodised aluminium frame ☐

L 44,7 P 2 x H 79,6 L 89,6 P 2 x H 79,6 L 44,7 P 2 x H 124,4 L 89,6 P 2 x H 124,4 L 44,7 P 2 x H 159,6 L 89,6 P 2 x H 159,6 L 44,7 P 2 x H 204,4 L 89,6 P 2 x H 204,4

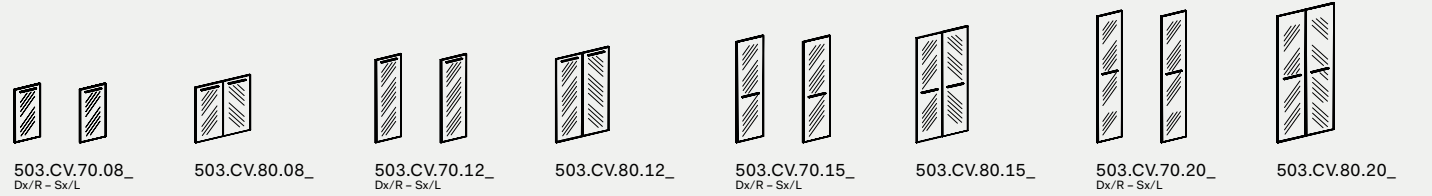

503.CV.70.08_ Dx/R - Sx/L 503.CV.80.08_ 503.CV.70.12_ Dx/R - Sx/L 503.CV.80.12_ 503.CV.70.15_ Dx/R - Sx/L 503.CV.80.15_ 503.CV.70.20_ Dx/R - Sx/L 503.CV.80.20_

Composizioni contenitori con ante in vetro acidato con telaio in alluminio dotate di serratura / Storage units compositions with acetated glass door with aluminium frame and lock

L 45 P 35 x H 127,5 L 45 P 45 x H 127,5 L 90 P 35 x H 127,5 L 90 P 45 x H 127,5

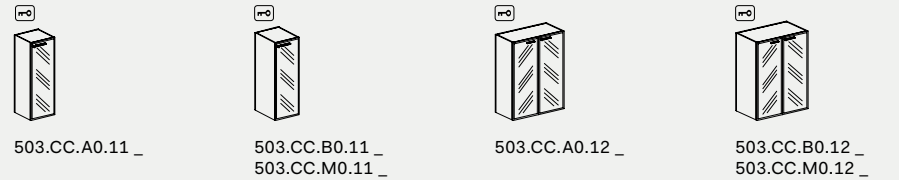

503.CC.A0.11_ 503.CC.B0.11_ 503.CC.M0.11_ 503.CC.A0.12_ 503.CC.B0.12_ 503.CC.M0.12_

Note:
503...A...P 33,2 / 503...B...P 43: Ripiano in melaminico/Melamine shelf
503...M...P 43: Ripiano in metallo/Metal shelf

Tipologie maniglie disponibili/Available handle typologies

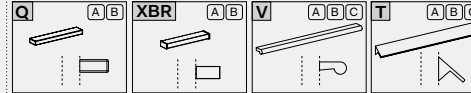

Maniglia "Q" + "XBR" utilizzabile solo con ante piene o ante in vetro acidate / Handle "Q" + "XBR" to be used only with wooden doors or acetated glass door

L 45 P 35 x H 162,7 L 45 P 45 x H 162,7 L 90 P 35 x H 162,7 L 90 P 45 x H 162,7

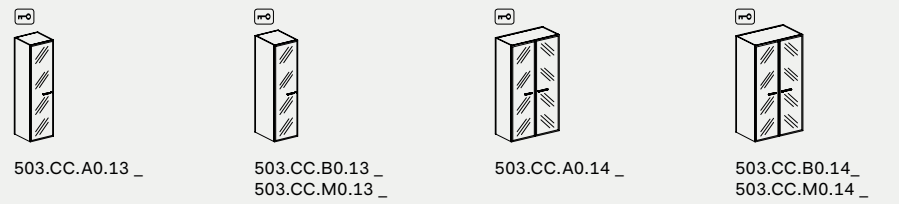

503.CC.A0.13_ 503.CC.B0.13_ 503.CC.M0.13_ 503.CC.A0.14_ 503.CC.B0.14_ 503.CC.M0.14_

L 45 P 35 x H 207,5 L 45 P 45 x H 207,5 L 90 P 35 x H 207,5 L 90 P 45 x H 207,5

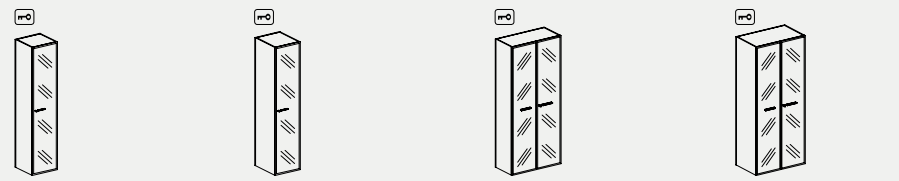

503.CC.A0.15_ 503.CC.B0.15_ 503.CC.M0.15_ 503.CC.A0.16_ 503.CC.B0.16_ 503.CC.M0.16_

L 45 P 35 x H 207,5 L 45 P 45 x H 207,5 L 90 P 35 x H 207,5 L 90 P 45 x H 207,5

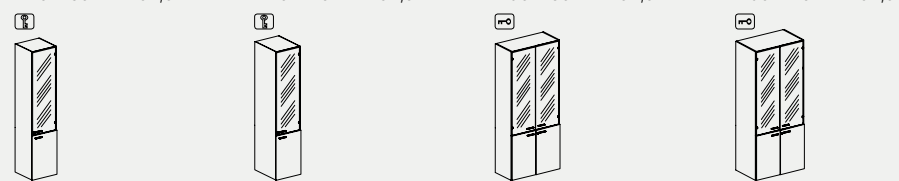

503.CC.A0.18_ 503.CC.B0.18_ 503.CC.M0.18_ 503.CC.A0.20_ 503.CC.B0.20_ 503.CC.M0.20_

Contenitori H 74/Storage units H 74

L 80 P 33 x 71,5 L 80 P 33 x 71,5



550.CG.01.08_ A giorno/Open 550.CC.02.08_ Con ante/With doors

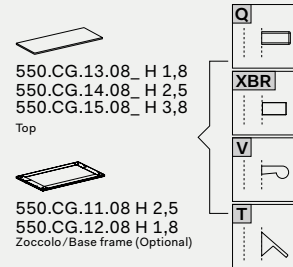

550.CG.13.08_ H 1,8
550.CG.14.08_ H 2,5
550.CG.15.08_ H 3,8
Top
550.CG.11.08_ H 2,5
550.CG.12.08_ H 1,8
Zoccolo/Base frame (Optional)

Note: Aggiungere sempre il Top sp. 1,8 o 2,5 (altezza totale è di 74 cm); 3,8 cm (altezza totale è di 75,5 cm) / Always add the 1,8 or 2,5 cm thick tops (height is 74 cm); 3,8 cm (height is 75,5 cm)

Componenti e accessori per contenitori/Components and accessories for storage units

H 2,8



550.CU.ZA.04_ L 44,9 P 33
550.CU.ZB.04_ L 44,9 P 42,8
550.CU.ZA.09_ L 89,9 P 33
550.CU.ZB.09_ L 89,9 P 42,8
Zoccoli metallici/Metal base frames
550.CS.P1.00_ L 33
550.CS.P2.00_ L 39
550.CS.P3.00_ L 33
550.CS.A3.08_ L 90
550.CS.A4.08_ L 90
550.CS.A5.08_ L 90

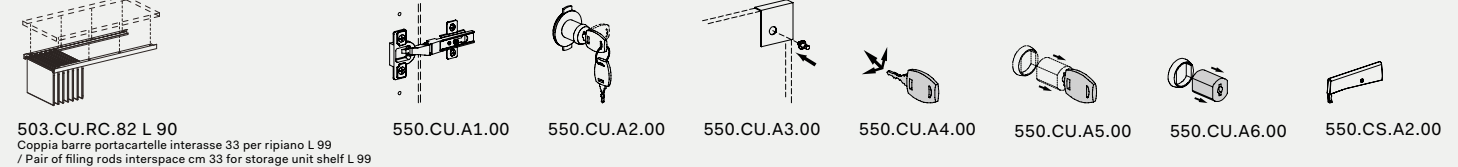

503.CU.RC.82 L 90
Coppia barre portacartelle interspazio 33 per ripiano L 99 / Pair of filing rods interspace cm 33 for storage unit shelf L 99
550.CU.A1.00 550.CU.A2.00 550.CU.A3.00 550.CU.A4.00 550.CU.A5.00 550.CU.A6.00 550.CS.A2.00

Componenti e accessori per contenitori/Components and accessories for storage units

P 35/45 x H 1,8

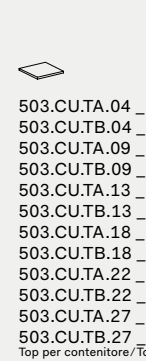

503.CU.TA.04_ L 45,1 P 35,5
503.CU.TB.04_ L 45,1 P 45,2
503.CU.TA.09_ L 90,1 P 35,5
503.CU.TB.09_ L 90,1 P 45,2
503.CU.TA.13_ L 135,1 P 35,5
503.CU.TB.13_ L 135,1 P 45,2
503.CU.TA.18_ L 180,1 P 35,5
503.CU.TB.18_ L 180,1 P 45,2
503.CU.TA.22_ L 225,2 P 35,5
503.CU.TB.22_ L 225,2 P 45,2
503.CU.TA.27_ L 270,2 P 35,5
503.CU.TB.27_ L 270,2 P 45,2
Top per contenitore/Top for unit

P 47,2 x H 1,8

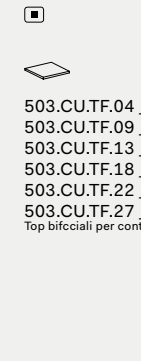

503.CU.TF.04_ L 45,1
503.CU.TF.09_ L 45,1
503.CU.TF.13_ L 135,1
503.CU.TF.18_ L 180,1
503.CU.TF.22_ L 225,2
503.CU.TF.27_ L 270,2
Top bifacciali per contenitore/Bifacial top for unit

L 1,8

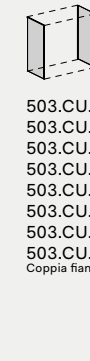

503.CU.FA.08_ P 35,5 x H 84,5
503.CU.FB.08_ P 45,2 x H 84,5
503.CU.FA.12_ P 35,5 x H 129,3
503.CU.FB.12_ P 45,2 x H 129,3
503.CU.FA.16_ P 35,5 x H 164,5
503.CU.FB.16_ P 45,2 x H 164,5
503.CU.FA.20_ P 35,5 x H 209,3
503.CU.FB.20_ P 45,2 x H 209,3
Coppia fianchi terminali/Pair of lateral side

P 1,8

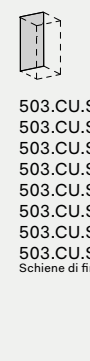

503.CU.SC.08.11_ L 44,9 x H 79,9
503.CU.SC.08.21_ L 89,9 x H 79,9
503.CU.SC.12.11_ L 44,9 x H 124,7
503.CU.SC.12.21_ L 89,9 x H 124,7
503.CU.SC.15.11_ L 44,9 x H 159,9
503.CU.SC.15.21_ L 89,9 x H 159,9
503.CU.SC.20.11_ L 44,9 x H 204,7
503.CU.SC.20.21_ L 89,9 x H 204,7
Schiene di finitura/Finishing backs

L 41,4 x H 2,5

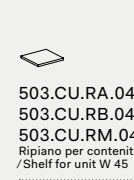

503.CU.RA.04_ P 29,8 (melam.)
503.CU.RB.04_ P 39,5 (melam.)
503.CU.RM.04_ P 39,5 (metal)
Ripiano per contenitore L 45 / Shelf for unit W 45

L 41,4 x H 2,5

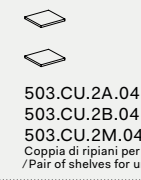

503.CU.2A.04_ P 29,8 (melam.)
503.CU.2B.04_ P 39,5 (melam.)
503.CU.2M.04_ P 39,5 (metal)
Coppia di ripiani per contenitore L 45 / Pair of shelves for unit W 45

L 86 x H 2,5



503.CU.RA.08_ P 29,8 (melam.)
503.CU.RB.08_ P 39,5 (melam.)
503.CU.RM.08_ P 39,5 (metal)
Ripiano per contenitore L 90 / Shelves for unit W 90

L 86 x H 2,5

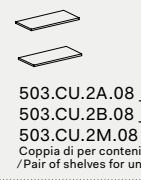

503.CU.2A.08_ P 29,8 (melam.)
503.CU.2B.08_ P 39,5 (melam.)
503.CU.2M.08_ P 39,5 (metal)
Coppia di per contenitore L 90 / Pair of shelves for unit W 90

L 41,4 x H 2,5

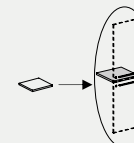

503.CU.PA.04_ P 31,2 (melam.)
503.CU.PB.04_ P 40,9 (melam.)
503.CU.PM.04_ P 40,9 (metal)
Ripiano per contenitore L 45 con ante sovrapposte o parziali / Shelf for unit W 45 with overlapped or partial doors

L 86,4 x H 2,5

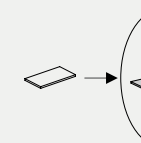

503.CU.PA.08_ P 31,2 (melam.)
503.CU.PB.08_ P 40,9 (melam.)
503.CU.PM.08_ P 40,9 (metal)
Coppia di ripiani per contenitore L 90 con ante sovrapposte o parziali / Pair of shelves for unit W 90 with overlapped or partial doors

L 86,4 x H 2,5

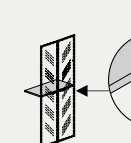

503.CU.VA.08_ P 29,8 (melam.)
503.CU.VB.08_ P 39,5 (melam.)
Ripiano per contenitore L 90 con coppia ante a vetro con telaio e serratura / Shelf for W90 unit with pair of tall glass doors with frame and lock

L 86,4 x H 2,5

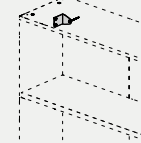

503.CU.KS.00
Kit staffe di fissaggio a muro per contenitori P 33,2 / Kit of wall fixing brackets for 33,2 D units

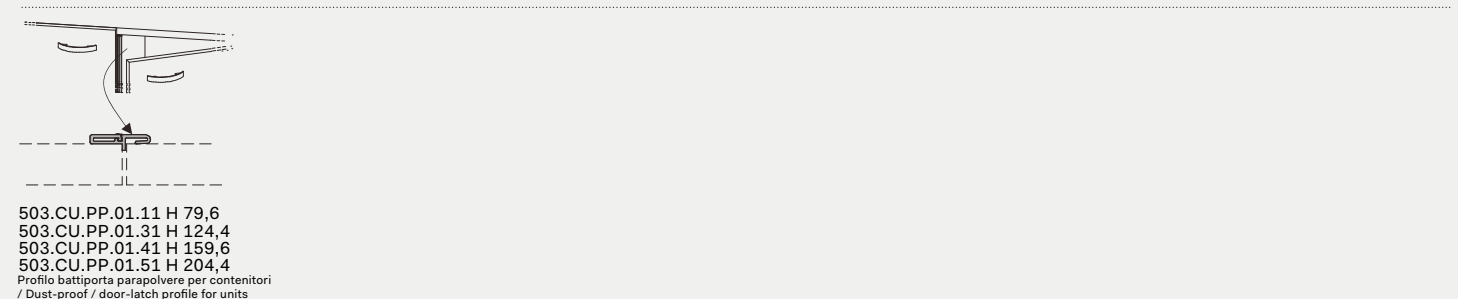

503.CU.PP.01.11 H 79,6
503.CU.PP.01.31 H 124,4
503.CU.PP.01.41 H 159,6
503.CU.PP.01.51 H 204,4
Profilo battiporta parapolvere per contenitori / Dust-proof / door-latch profile for units

Note:

- 1 Le dimensioni sono espresse in cm – consultare il listino prezzi per le caratteristiche tecniche, i codici degli articoli e delle finiture/Dimensions are stated in cm – for technical characteristics, article code numbers and finishing see price list;
- 2 La finitura impiallacciato non è in pronta consegna. Per la disponibilità contattare l'ufficio commerciale /Veneered finish is not in prompt delivery. Please contact the commercial department to check availability;
- 3 I contenitori sono componibili, sovrapponibili e vanno completati con i top/storage units are modular, stackable and they must be completed with tops;
- 4 Prodotti non in pronta consegna. Per la disponibilità contattare l'ufficio commerciale/Items not in prompt delivery. Please contact the commercial department to check availability;
- ☐ Con serratura/With lock;
- ☐ Con serratura (solo ante superiori in vetro) /With lock (only upper glass door);
- ☐ Fino ad esaurimento/Until exhaustion.

DV504 Milo

Design:
Enzo Berti

IT È un sistema di madie su basamenti e contenitori pensili, in diversi colori, agganciati ad una barra retroilluminata che ricorda la linea dell'orizzonte e contribuisce a conferire un senso di benessere all'ambiente ufficio. Possono essere posizionati liberamente sulla barra oppure essere appesi a parete. DV504 Milo con il suo stile e i suoi colori si integra armoniosamente sia nell'ambiente ufficio che domestico.

EN DV504 Milo is a system of sideboards with floor and wall units, in different colours, hooked to a backlit bar that recalls the horizon and helps give a sense of wellbeing to the office. They can be freely positioned on the bar or hung on the wall. Thanks to its versatile design and the trendy colours, DV504 Milo harmoniously fits in any residential or office environment.











Sistema di madie, pensili e barre a muro /
System of sideboards, hanging unit and wall bars

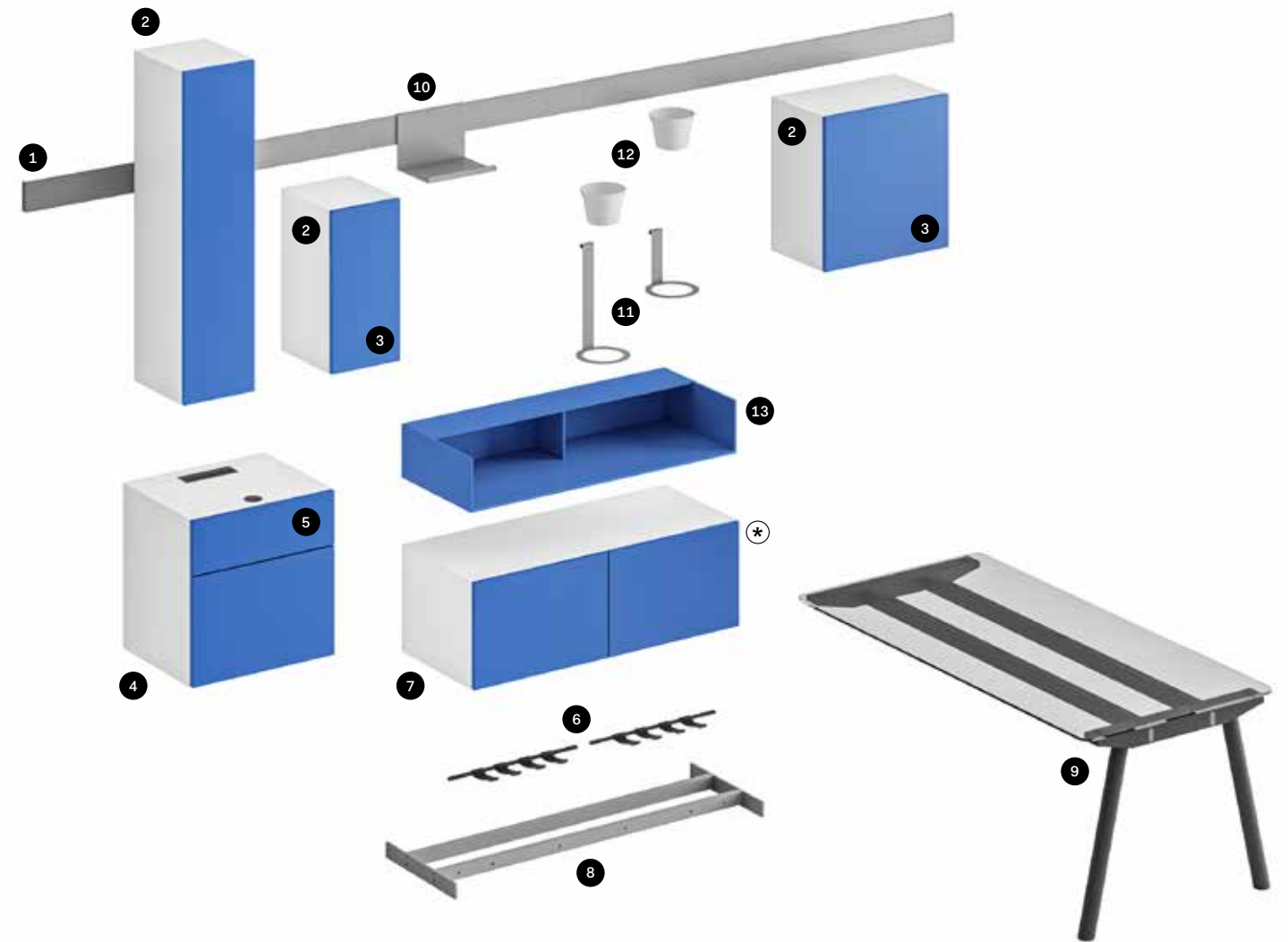

1 Barra a muro L. 240 cm /
Wall Bar W. 93 31/64"

2 Pensile su barra /
Storage hanging unit on bar

3 Anta piena /
Wooden doors

4 Modulo tecnico con passacavi /
Technical module with
cable management

5 Frontale modulo tecnico /
Front panel of technical module

6 Canalina (Optional) /
Wire management (Optional)

7 Modulo base (*) /
Base module

8 Zoccolo in lamiera
H. 6 cm /
Sheet metal plinth H. 2 3/8"

9 Tavolo scrivania
con piano in vetro (serie DV911) /
Desk with glass worktop (DV911 series)

10 Mensola per barra /
Shelf for bar

11 Portavaso per barra /
Flowerpot holder for bar

12 Vaso / Flowerpot

13 Modulo superiore /
Superior module

(*) I moduli base non sono dotati di piedini. Vanno sempre completati con gli zoccoli metallici o in melaminico /
Base modules are not equipped with levelling feet. They must always be completed with metal or melamine plinths

Moduli base a giorno / Open modules

Altezza	Height	Larghezza	Width	Profondità	Depth
A - 40 cm	H - 15 3/4"	L - 60 cm	W - 23 5/8"	P - 48 cm	D - 18 3/4"
A - 60 cm	H - 23 5/8"	L - 120 cm	W - 47 1/4"		
A - 120 cm	H - 47 1/4"				

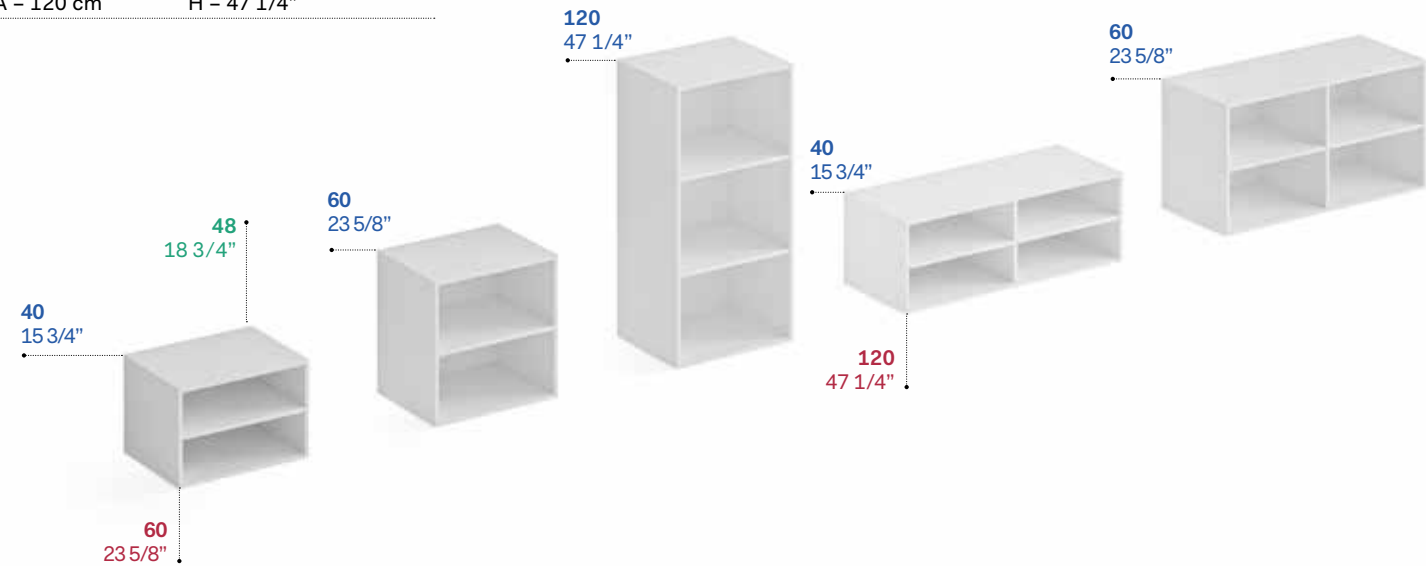

Moduli base con ante / Modules with doors

Altezza	Height	Larghezza	Width	Profondità	Depth
A - 40 cm	H - 15 3/4"	L - 60 cm	W - 23 5/8"	P - 50 cm	D - 19 3/4"
A - 60 cm	H - 23 5/8"	L - 120 cm	W - 47 1/4"		
A - 120 cm	H - 47 1/4"				

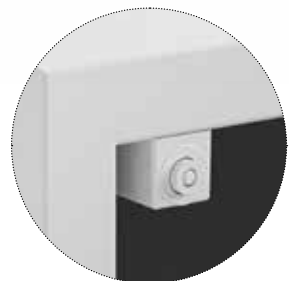
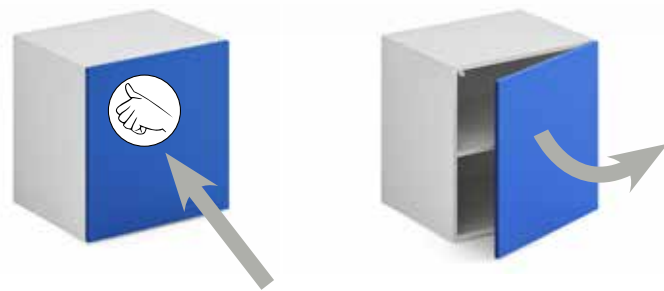
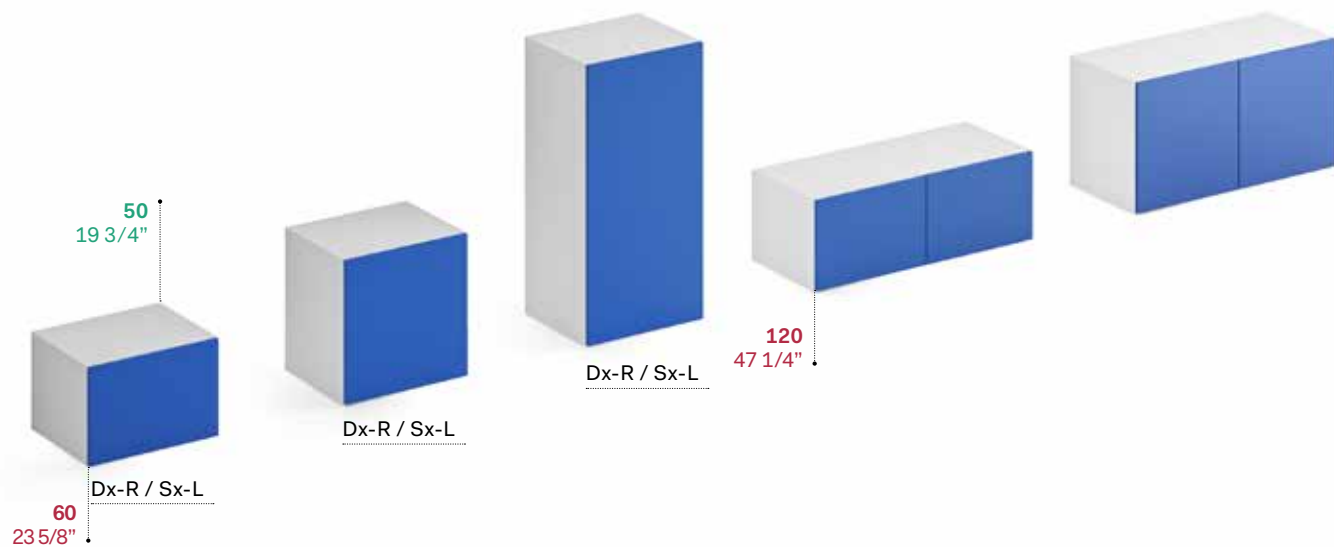

Le ante sono fornite con meccanismo di apertura push-pull / Doors are supplied with push-pull opening mechanism

Moduli base con cassetti / Modules with drawers

Altezza	Height	Larghezza	Width	Profondità	Depth
A - 40 cm	H - 15 3/4"	L - 60 cm	W - 23 5/8"	P - 50 cm	D - 19 3/4"
A - 60 cm	H - 23 5/8"	L - 120 cm	W - 47 1/4"		

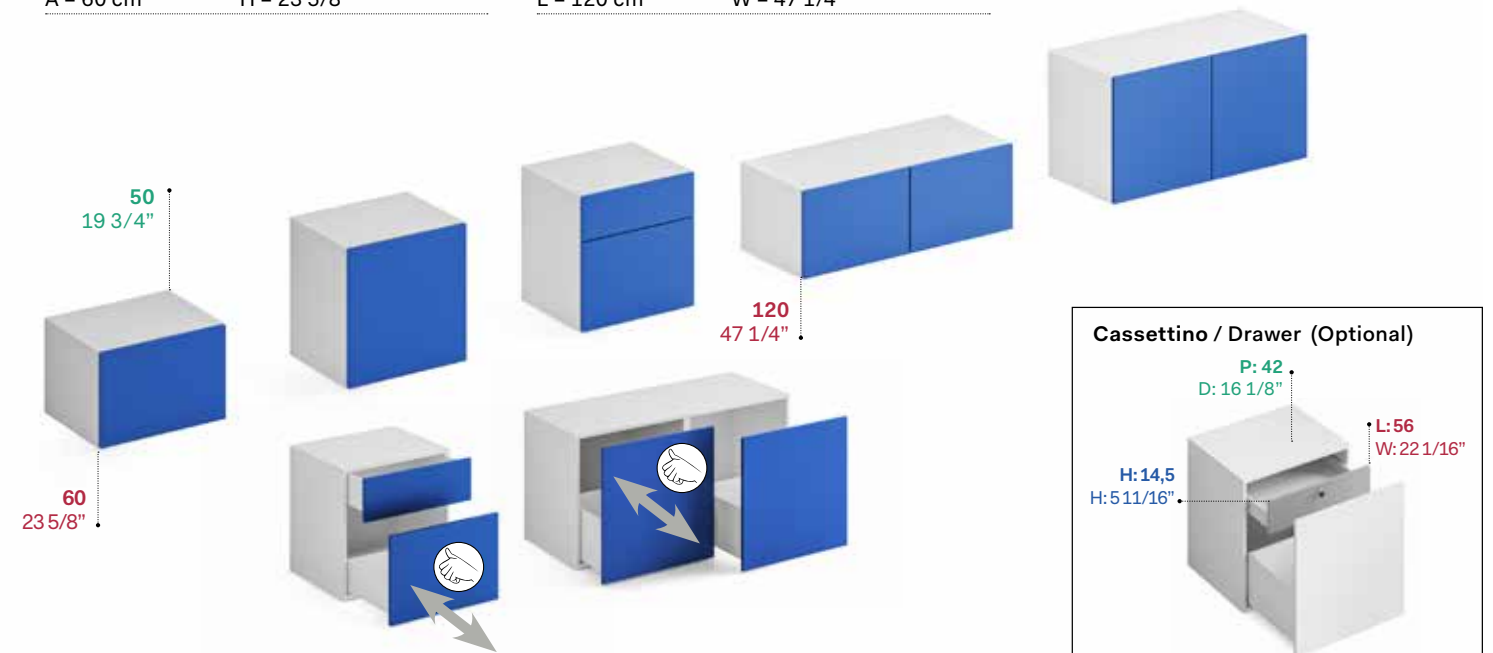

Cassettino / Drawer (Optional)

N.B.: I cassettini sono dotati di serratura / N.B.: Drawers are equipped with lock

Note: I cassetti sono dotati di guide ad estrazione totale push-pull / The drawers are equipped with total sliding extraction guides with push-pull

Moduli con vano tecnico per integrazione tavoli / Modules with technical compartment for desk integration

Altezza	Height	Larghezza	Width	Profondità	Depth
A - 40 cm	H - 15 3/4"	L - 60 cm	W - 23 5/8"	P - 50 cm	D - 19 3/4"
A - 60 cm	H - 23 5/8"				

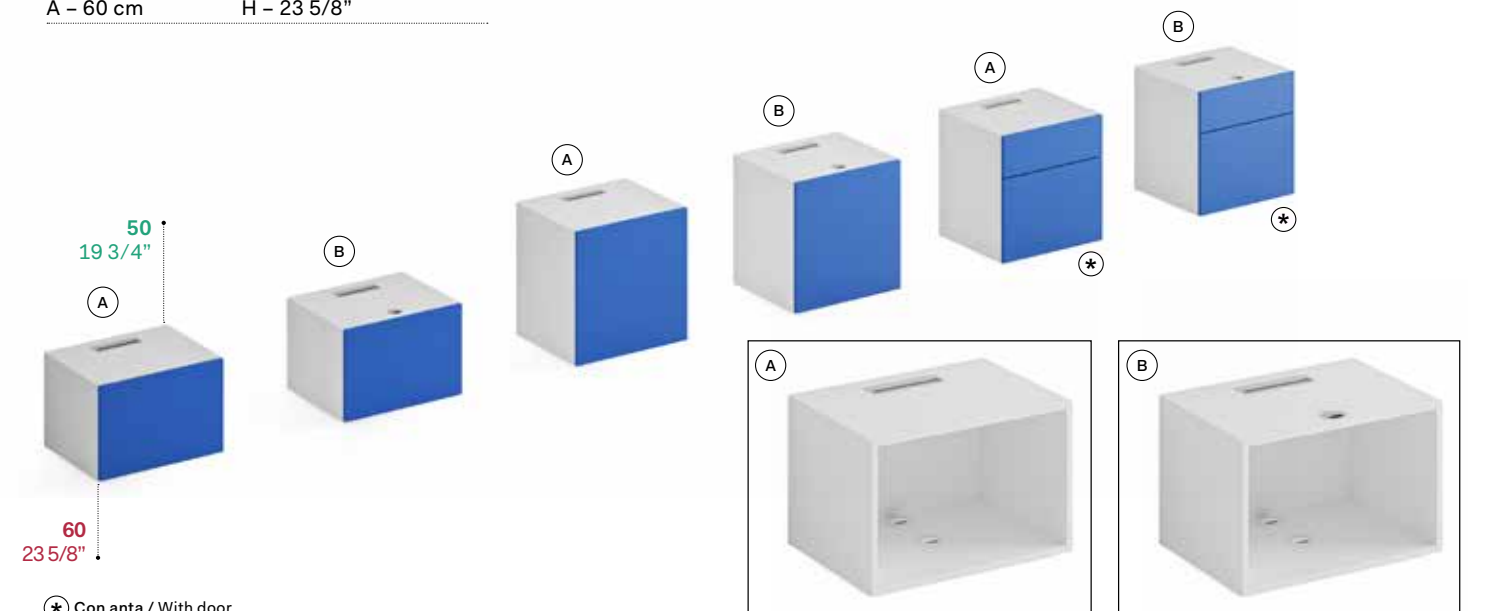

* Con ante / With door

Ante per moduli tecnici / Doors for technical modules



Frontali fissi per moduli tecnici / Fixed fronts for technical modules

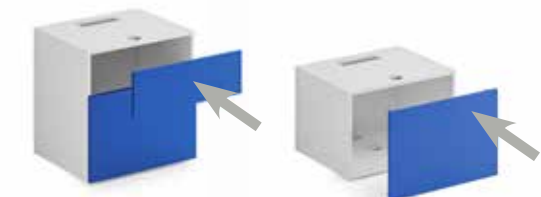

Moduli superiori / Superior module

Altezza	Height	Larghezza	Width	Profondità	Depth
A - 20 cm	H - 7 7/8"	L - 60 cm	W - 23 5/8"	P - 48 cm	D - 18 3/4"
		L - 120 cm	W - 47 1/4"		



Modulo pensile / Overhead module

Altezza	Height	Larghezza	Width	Profondità	Depth
A - 30 cm	H - 11 7/8"	L - 30 cm	W - 11 7/8"	P - 34 cm	D - 13 3/8"
A - 60 cm	H - 23 5/8"	L - 60 cm	W - 23 5/8"		
A - 120 cm	H - 47 1/4"	L - 120 cm	W - 47 1/4"		

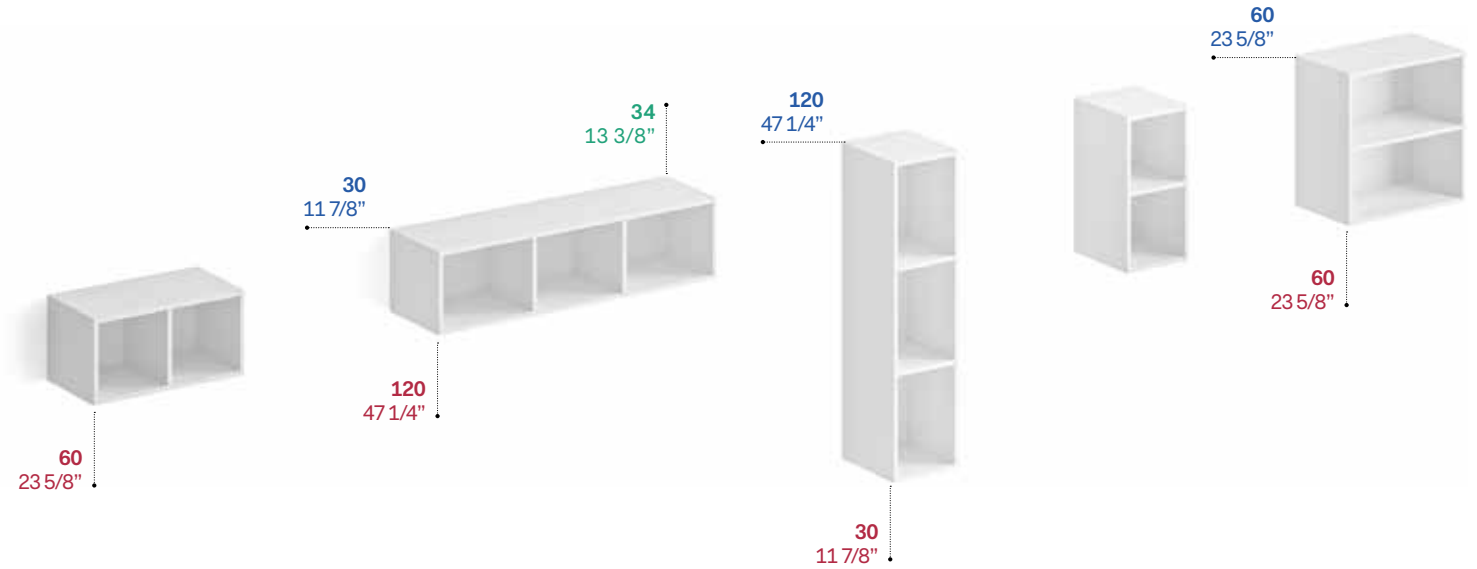

Schiene di finitura / Finishing back panel

Altezza	Height	Larghezza	Width	Profondità	Depth
A - 40 cm	H - 15 3/4"	L - 60 cm	W - 23 5/8"	P - 1,8 cm	D - 23/32"
A - 60 cm	H - 23 5/8"	L - 120 cm	W - 47 1/4"		
A - 120 cm	H - 47 1/4"	L - 180 cm	W - 70 7/8"		

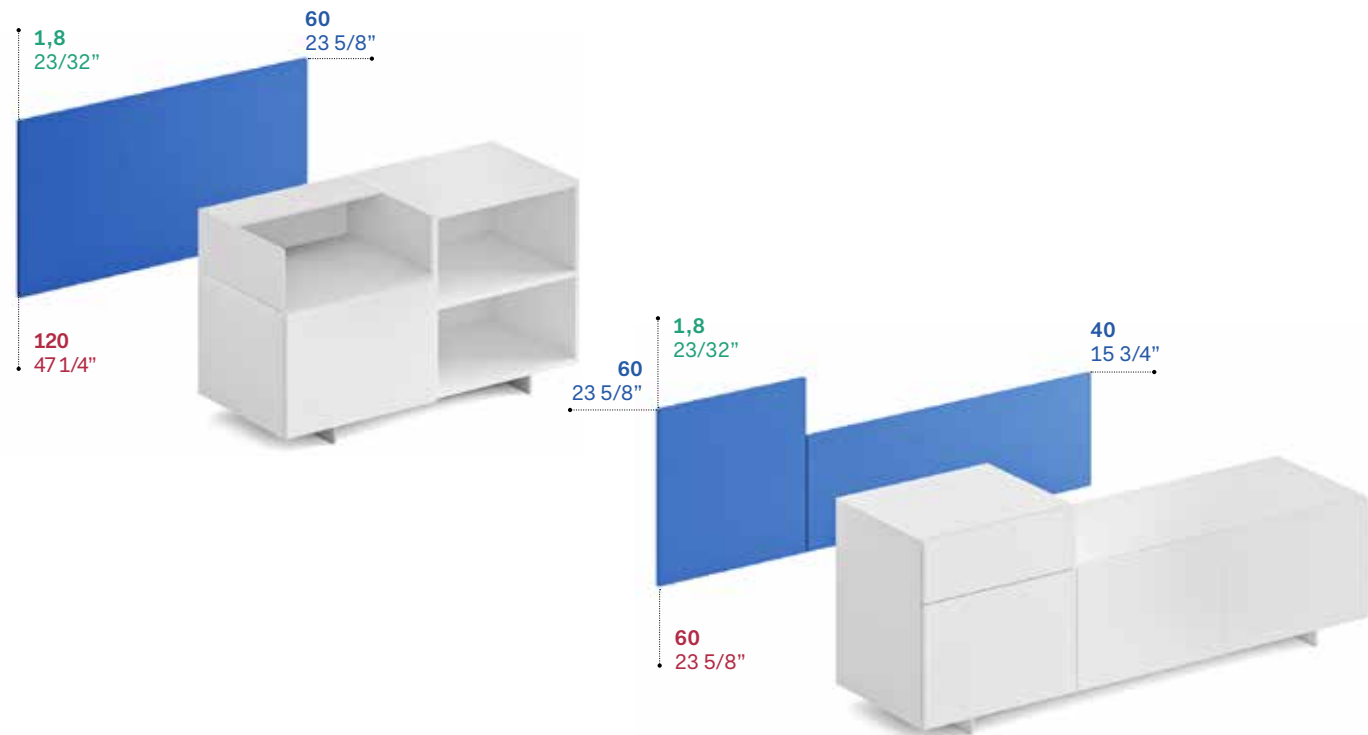

Modulo pensile con ante / Overhead module with doors

Altezza	Height	Larghezza	Width	Profondità	Depth
A - 60 cm	H - 23 5/8"	L - 30 cm	W - 11 7/8"	P - 36 cm	D - 14 3/16"
A - 120 cm	H - 47 1/4"	L - 60 cm	W - 23 5/8"		

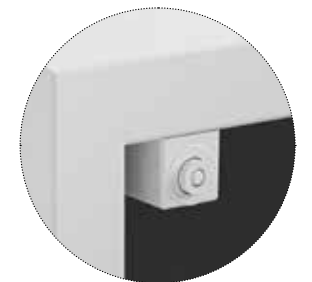
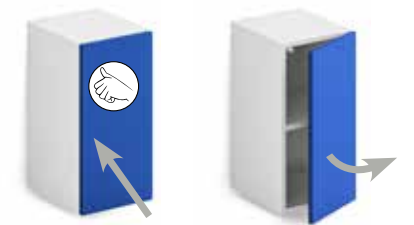
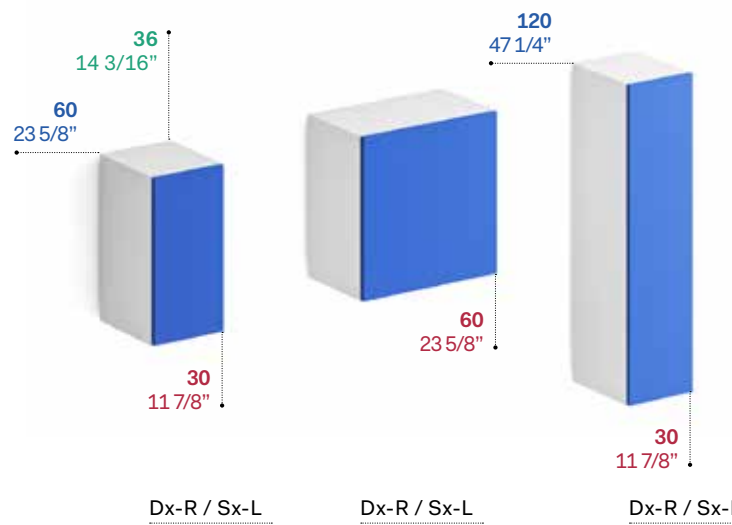

[Note:] Pensili integrabili alla barra o a parete / Overhead for integration to bar or wall

Le ante sono fornite con meccanismo di apertura push-pull / Doors are supplied with push-pull opening mechanism

Zoccoli in lamiera e melaminico / Sheet metal and melamine plinths

Altezza lamiera	Sheet metal Height
A - 6,1 cm	H - 2 3/8"
A - 26,1 cm	H - 10 2/8"

Larghezza lamiera	Sheet metal Width
L - 80 cm	W - 31 1/2"
L - 140 cm	W - 55 1/8"
L - 200 cm	W - 78 6/8"

Profondità	Depth
P - 48 cm	D - 18 3/4"

Altezza melaminico	Melamine Height
A - 26,1 cm	H - 10 2/8"

Larghezza melamin.	Melamine Width
L - 86 cm	W - 33 7/8"
L - 146 cm	W - 57 1/2"
L - 206 cm	W - 81 1/8"

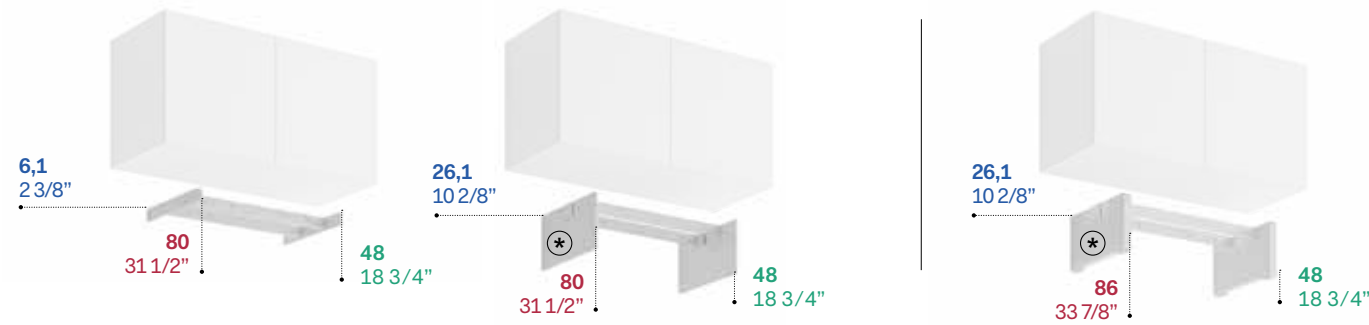

⊛ Carter di copertura zoccolo / Covering plinth carter

Esempi di zoccoli A: 6,1 - 26,1 cm / Plinths examples H: 2 3/8" - 10 2/8"

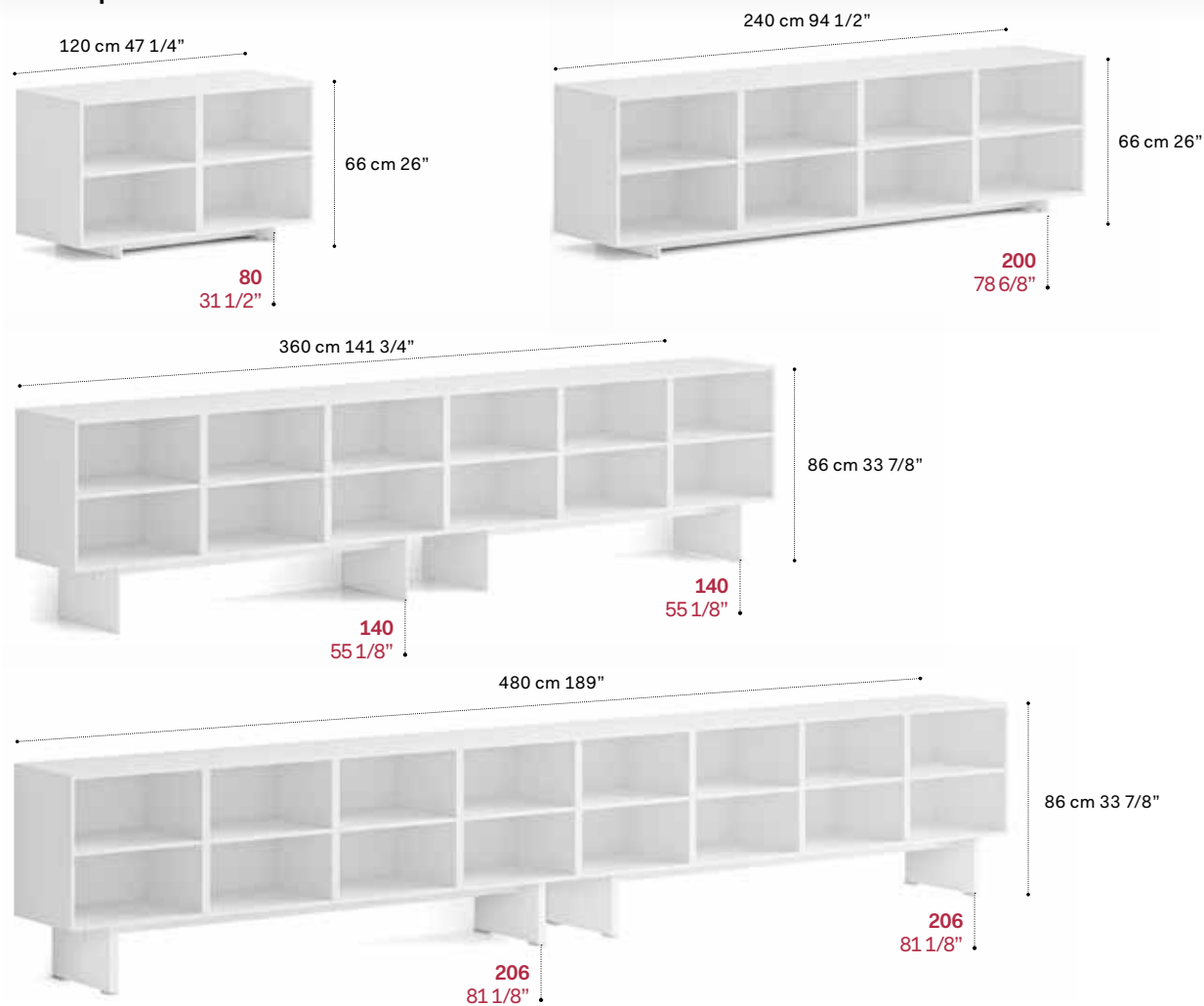

Note: Tutti i moduli base, i moduli con cassetti ed i moduli tecnici, devono essere completati con gli zoccoli in lamiera o in melaminico / All base modules, the modules with drawers and technical modules must be completed with the sheet metal or melamine plinth

Esempi di composizione con moduli sovrapposti / Composition examples with superimposed modules

Comp. 1

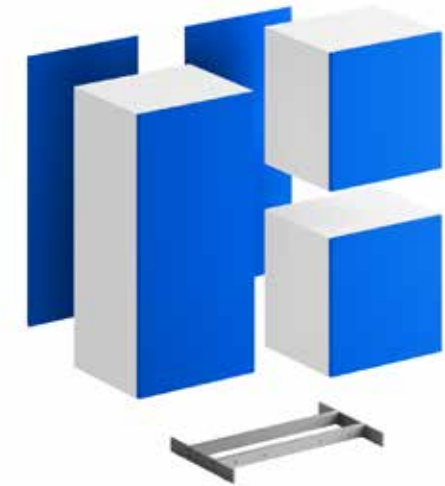

Comp. 2

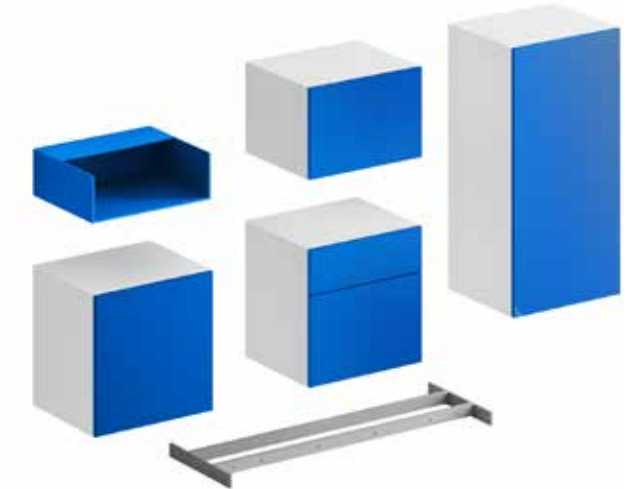

Comp. 3

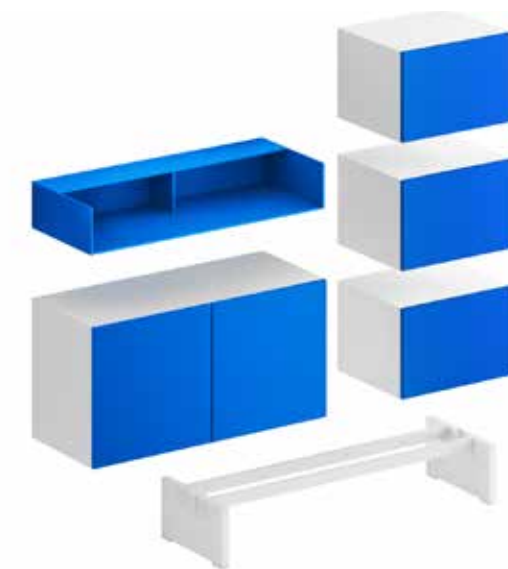

Note: I moduli base possono essere sovrapposti fino al raggiungimento massimo di 120 cm di altezza / The base modules can be superimposed up to a maximum of 47 1/4" in height

**Esempio di canalizzazione con modulo tecnico H. 60 cm e tappo passacavi superiore /
Example of wire management with technical module 23 5/8" height and upper outlet lid**

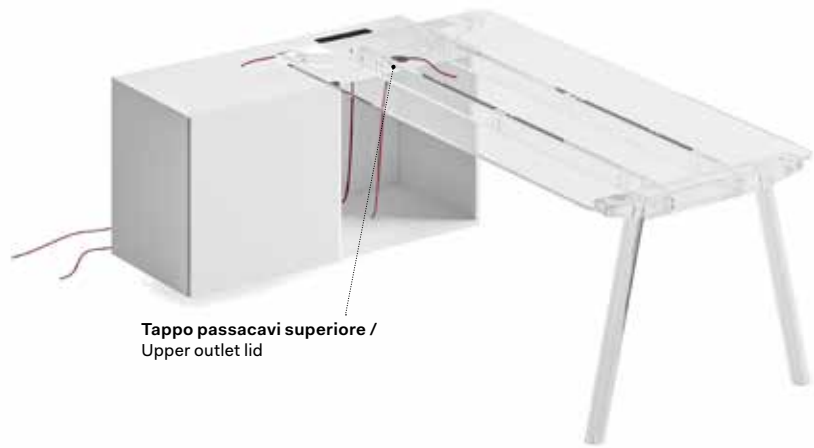

**Esempio di canalizzazione con modulo tecnico H. 60 cm /
Example of wire management with technical module 23 5/8" height**



**Esempio di canalizzazione con modulo tecnico H. 40 cm /
Example of wire management with technical module 15 3/4" height**

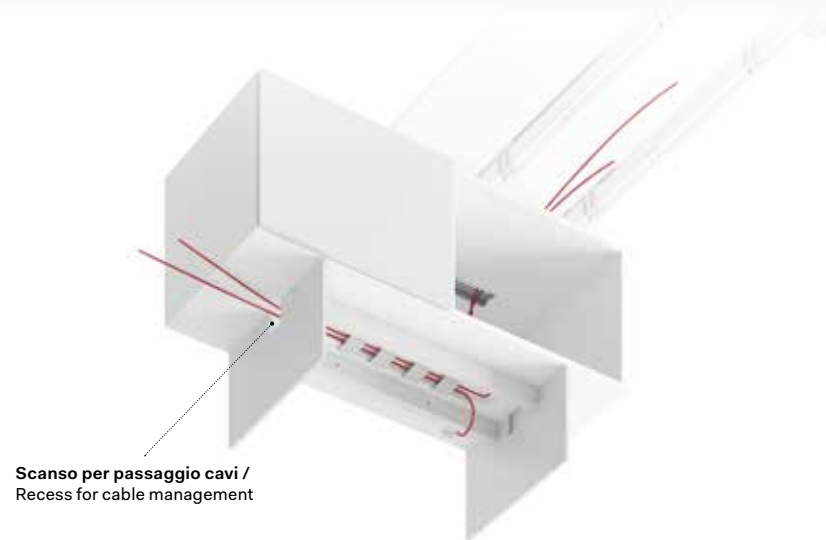

[Note:] Per la canalizzazione dei tavoli scrivania DV911 consultare il relativo capitolo del manuale tecnico / For the wire management of the DV911 desk, refer to the relevant chapter of the technical manual. Tutti i moduli tecnici sono muniti di top access superiore e 2 tappi passacavi sul fondo / All technical modules are equipped with top access and 2 outlet lids on the bottom.

**Capacità di archiviazione moduli base e pensili /
Storage capacity base modules and wall unit**

Altezza	Height
A - 40 cm	H - 15 3/4"
A - 60 cm	H - 23 5/8"
A - 120 cm	H - 47 1/4"

Larghezza	Width
L - 30 cm	W - 11 7/8"
L - 60 cm	W - 23 5/8"
L - 120 cm	W - 47 1/4"

Profondità	Depth
P - 34 cm	D - 13 3/8"
P - 36 cm	D - 14 13/16"
P - 50 cm	D - 19 3/4"

L: 60 - W: 23 5/8"

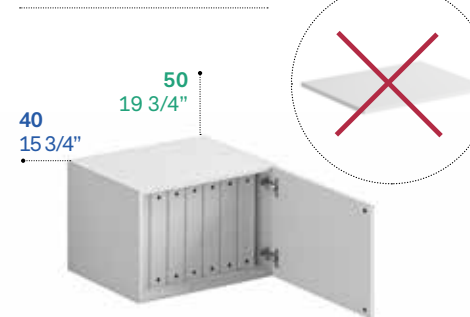

6 Dox con ante / Dox with doors
6 Dox a giorno / Dox open

L: 60 - W: 23 5/8"



6 Dox con ante / Dox with doors
6 Dox a giorno / Dox open

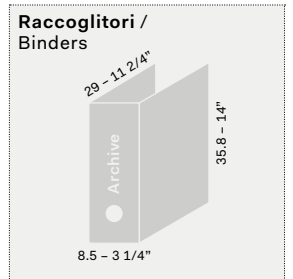

L: 60 - W: 23 5/8"



18 Dox con ante / Dox with doors
18 Dox a giorno / Dox open

L: 120 - W: 47 1/4"

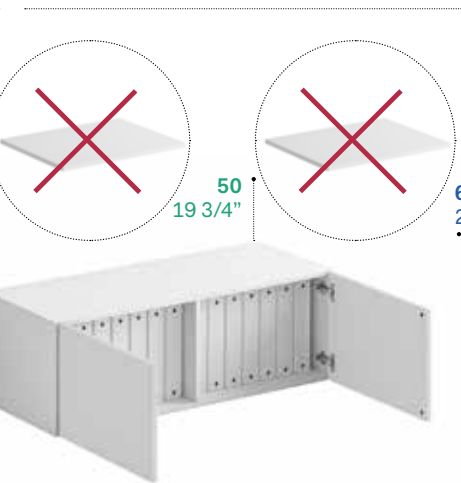

12 Dox con ante / Dox with doors
12 Dox a giorno / Dox open

L: 120 - W: 47 1/4"



12 Dox con ante / Dox with doors
12 Dox a giorno / Dox open

L: 30 - W: 11 7/8"



6 Dox con ante / Dox with doors

L: 60 - W: 23 5/8"



9 Dox a giorno / Dox open

L: 60 - W: 23 5/8"

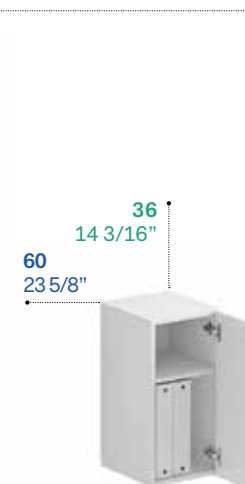

2 Dox con ante / Dox with doors

L: 60 - W: 23 5/8"

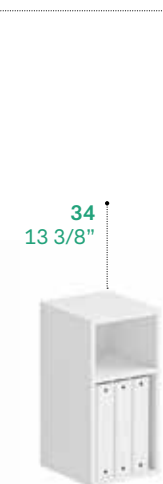

3 Dox a giorno / Dox open

L: 60 - W: 23 5/8"

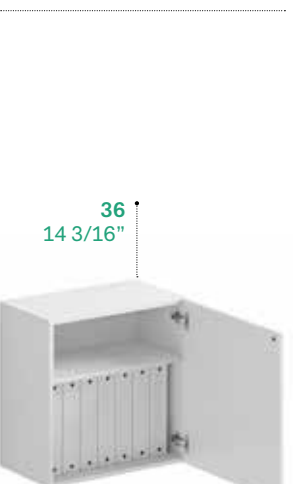

6 Dox con ante / Dox with doors
6 Dox a giorno / Dox open

Capacità di archiviazione pensili / Storage capacity wall unit

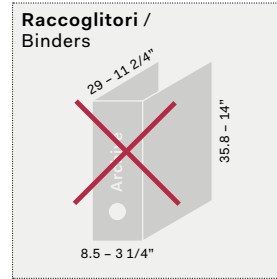
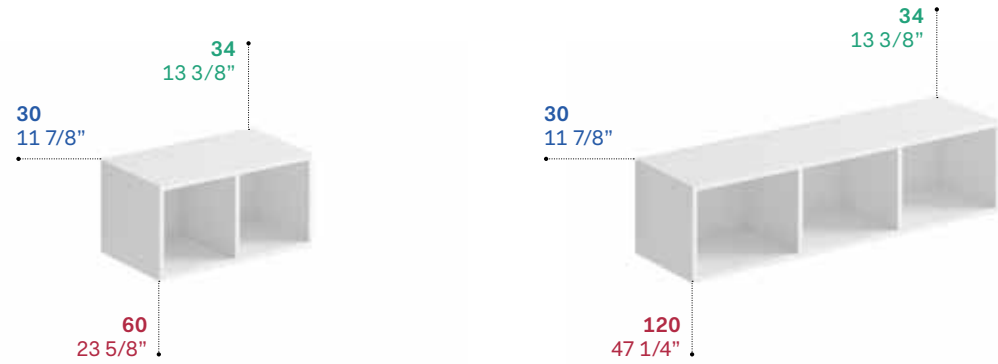

Portata massima dei ripiani con carico uniformemente distribuito / Maximum static load of the shelves with a uniformly distributed load



Portata ripiani = Kg 30 - 66 lbs / Static load on shelf = 30 kg - 66 lbs

Note: Portata massima di ogni contenitore 100 Kg / Maximum static load of each storage unit: 220 lbs

Portata massima dei pensili con carico uniformemente distribuito / Maximum capacity of the wall units with uniformly distributed load

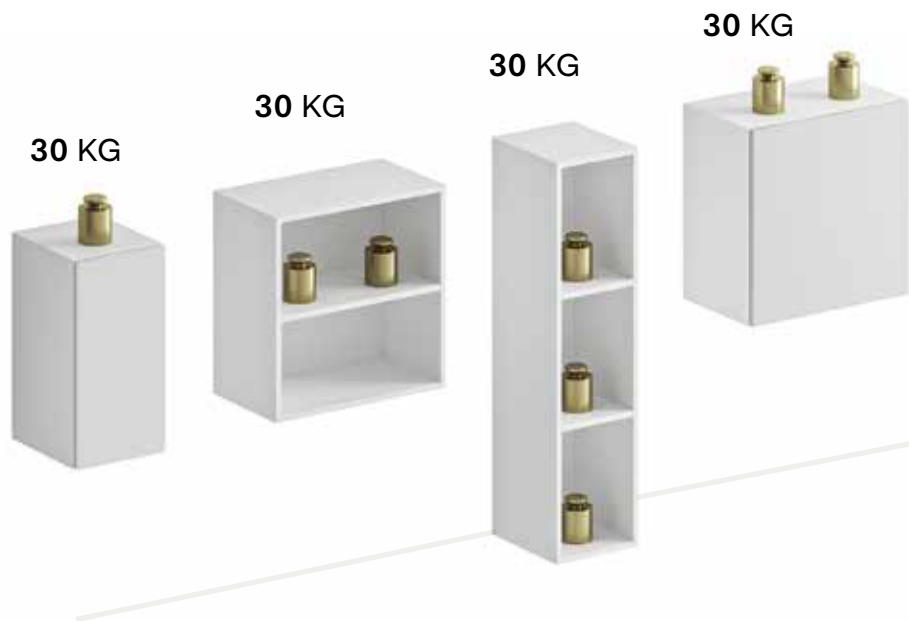

Capacità di archiviazione dei cassetti / Drawer storage capacity

Altezza A - 40 cm A - 60 cm	Height H - 15 3/4" H - 23 5/8"	Larghezza L - 60 cm L - 120 cm	Width W - 23 5/8" W - 47 1/4"	Profondità P - 50 cm	Depth D - 19 3/4"
-----------------------------------	--------------------------------------	--------------------------------------	-------------------------------------	-------------------------	----------------------

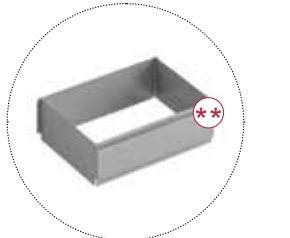
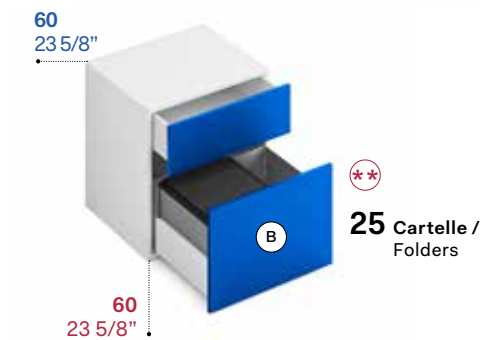
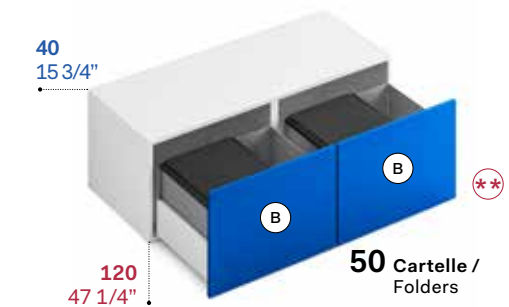
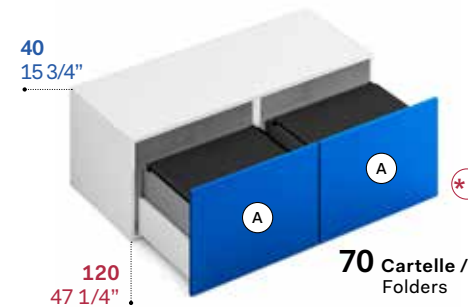
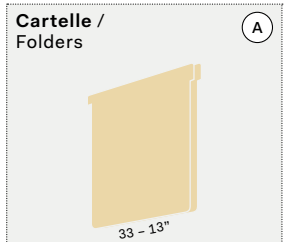
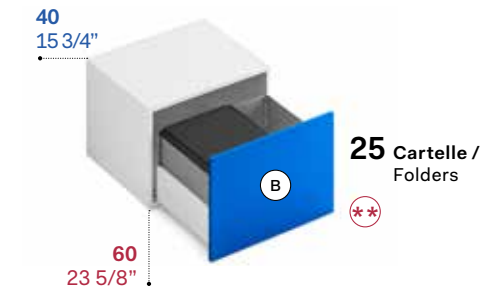
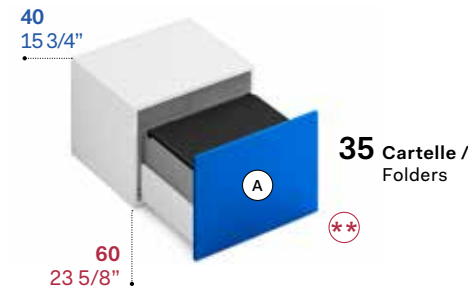

OPTIONAL
Reggicartella per cassetto
H. 40 cm /
Frame for folders for drawers
h. 15 3/4"

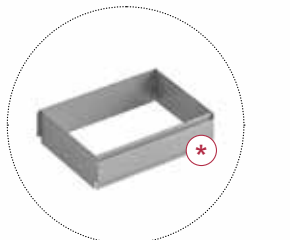
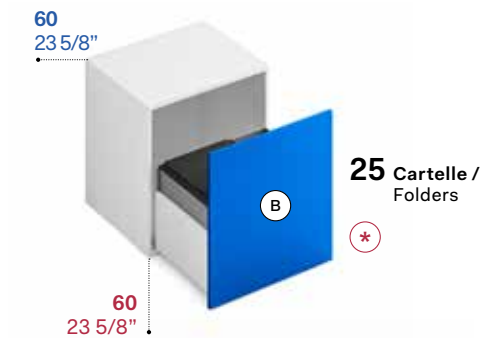
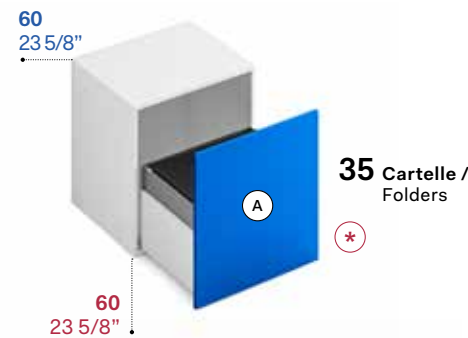

OPTIONAL
Reggicartella per cassetto
H. 60 cm /
Frame for folders for drawers
h. 23 5/8"

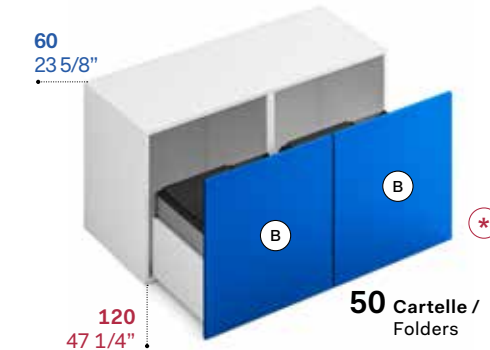
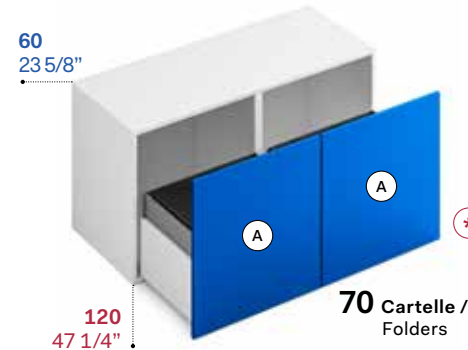

**Barra a muro /
Wall bar**

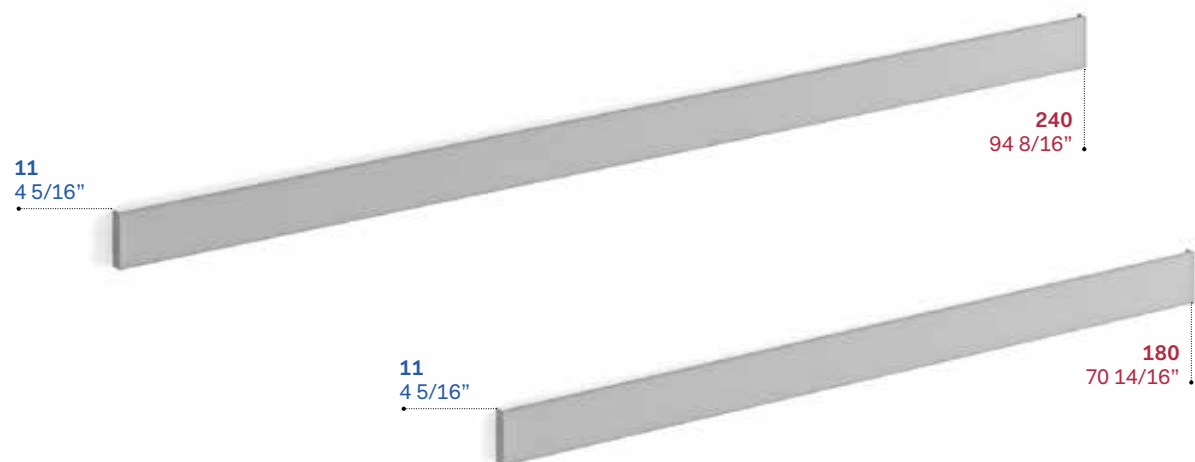

LED N.B.: La barra a muro è disponibile anche con illuminazione a LED (alimentatore incluso) /
N.B.: The wall bar is also available with LED lighting (electrical feeder included)

Note: I tasselli di fissaggio sono a carico del cliente che deve sceglierli in base alle caratteristiche strutturali del muro e a quelle dettate dal costruttore di tasselli /
The wall fitting plugs are not provided. Customers must chose the most suitable ones, depending on wall structure characteristics and according to plugs manufacturer's instructions.

**Barra a muro abbinata a pensili e tavolo DV911 /
Wall bar combined with hanging wall unit and DV911 desk**



Note: La portata della barra varia a seconda delle caratteristiche strutturali del muro e dei fissaggi a parete utilizzati. Per il fissaggio dei tavoli scrivania DV911 alla barra a muro, consultare il relativo capitolo del manuale tecnico. / The capacity of the bar varies according to the structural characteristics of the wall and the wall fixings used. For fixing the DV911 desk to the wall bar, refer to the relevant chapter of the technical manual.

**Pensili su barra a muro /
Wall hanging storage units on wall bar**

Posizione alta /
High position



Posizione intermedia /
Intermediate position

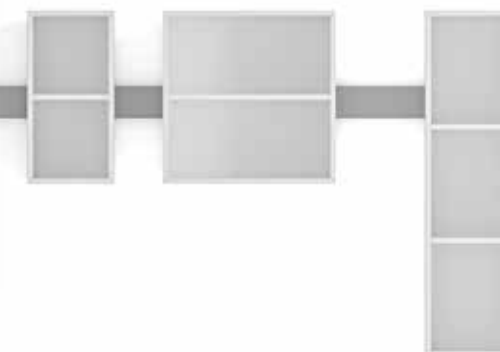

Posizione bassa /
Low position

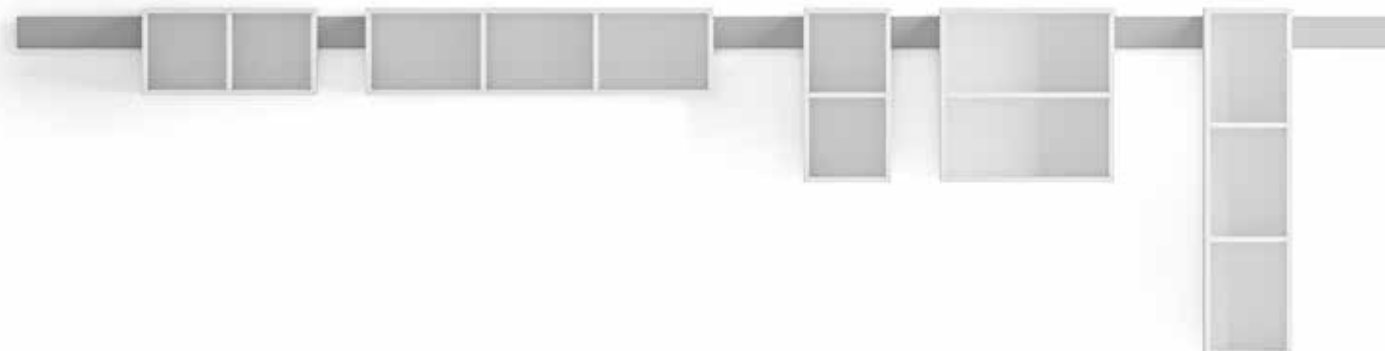

**Accessori su barra a muro /
Wall bar accessories**

A: 20 - H: 7 7/8" L: 30 - W: 11 7/8" P: 21 - D: 8 1/4"

A: 10 - H: 3 15/16" L: 3 - W: 1 3/16" P: 4 - D: 1 9/16"

A: 20 - H: 7 7/8" L: 3 - W: 1 3/16" P: 4 - D: 1 9/16"

**Mensola /
Shelf**



**Appendini /
Hanger**



A: 20 - H: 7 7/8" L: 20 - W: 7 7/8" P: 22 - D: 8 11/16"

A: 40 - H: 15 3/4" L: 20 - W: 7 7/8" P: 22 - D: 8 11/16"

Ø 18 - 7 1/8"

**Portavaso /
Flowerpot holder**



**Vaso /
Flowerpot**



Tavolo scrivania orientabile / Swivel table



1 Modulo base / Base module

2 Anta piena / Wooden doors

3 Zoccolo in lamiera H. 26 cm / Sheet metal plinth H. 10 15/64"

4 Staffa di supporto per tavolo orientabile / Support bracket for swivel table

5 Tavolo scrivania orientabile / Swivel table

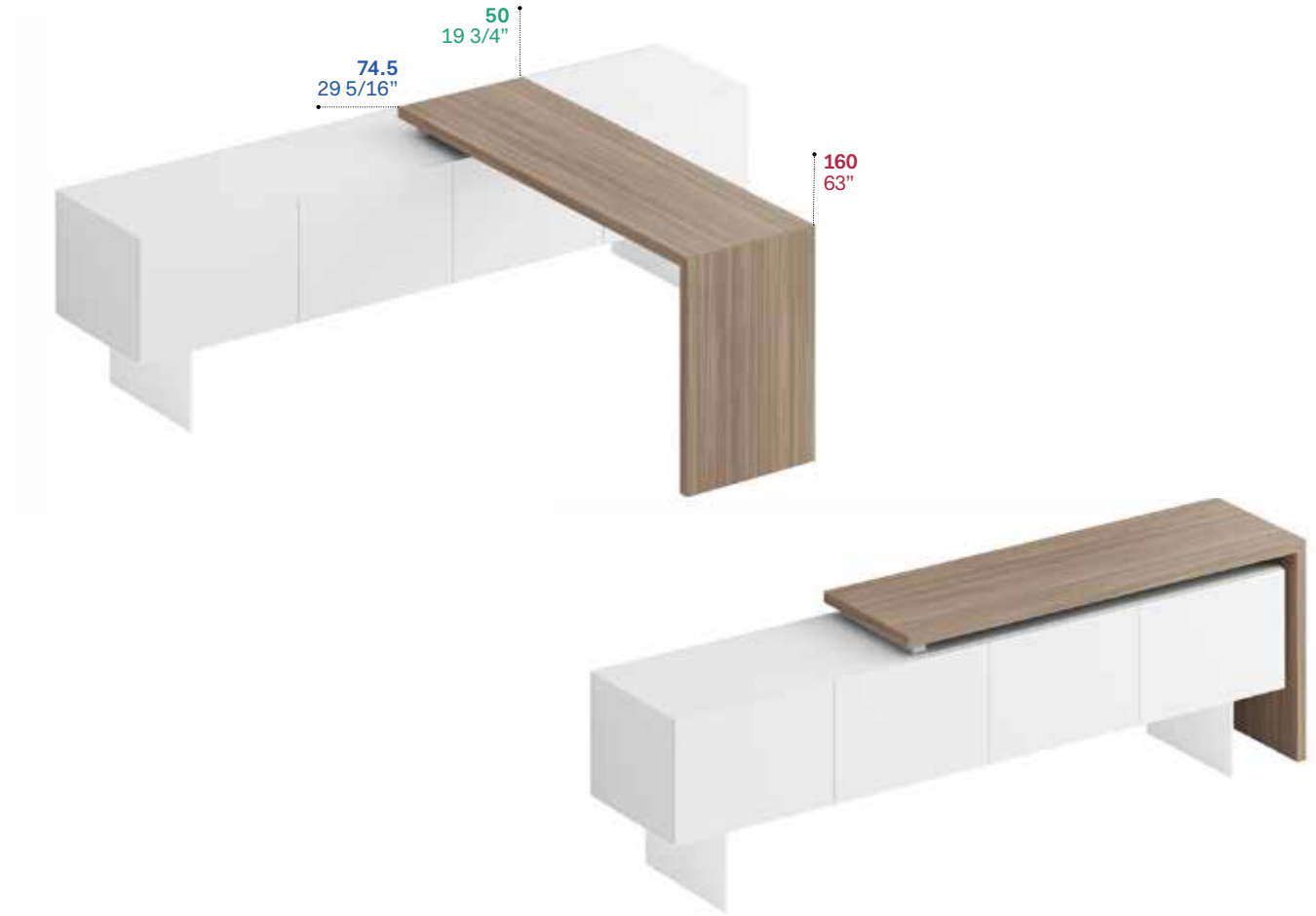

Posizione 1 / Position



Posizione 2 / Position



Posizione 3 / Position



Rotazione / Rotation

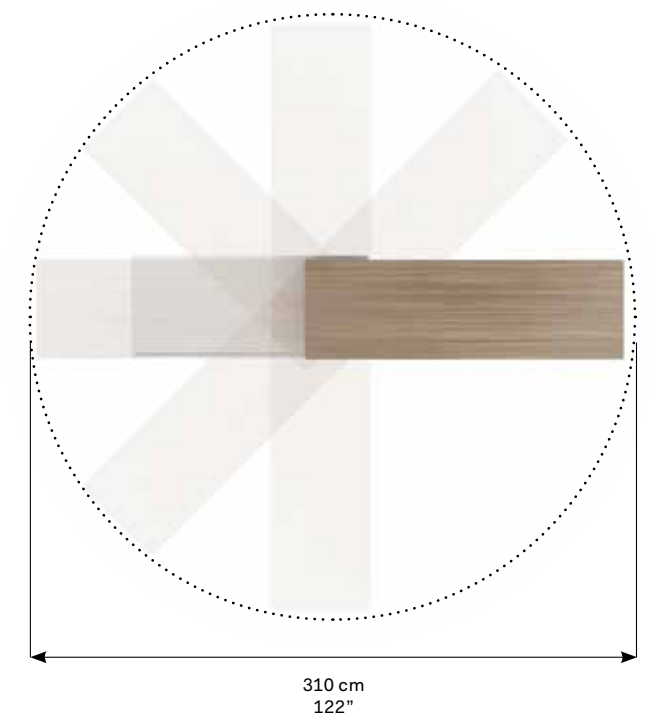

Esempi di composizioni / Composition examples

Comp. 1



Comp. 2

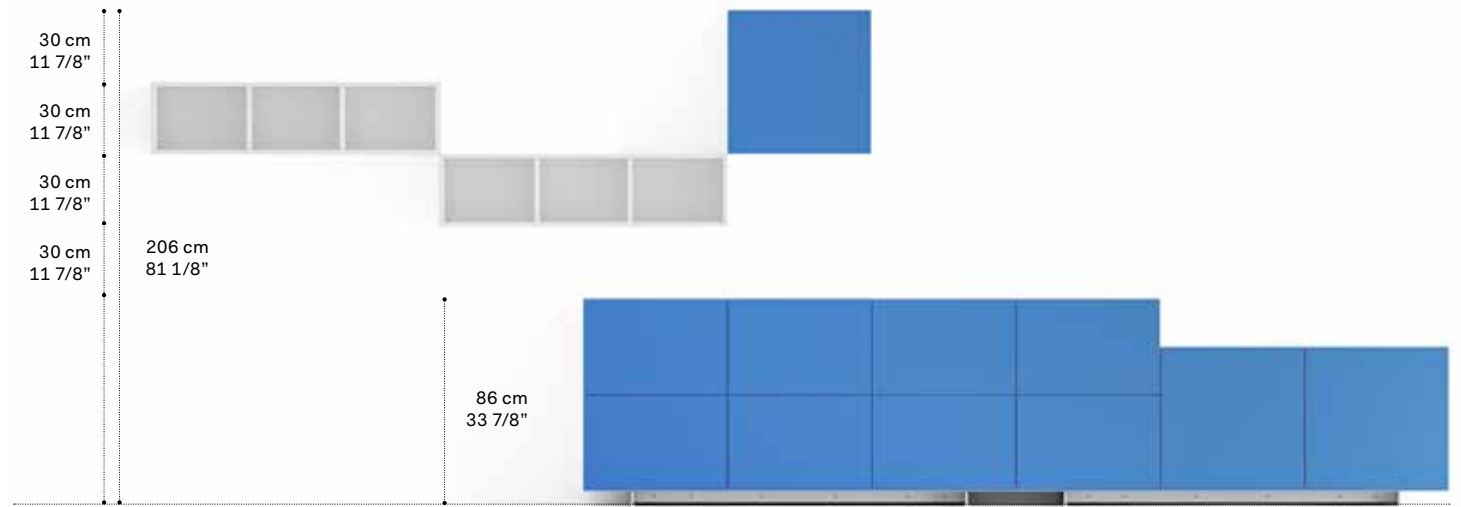
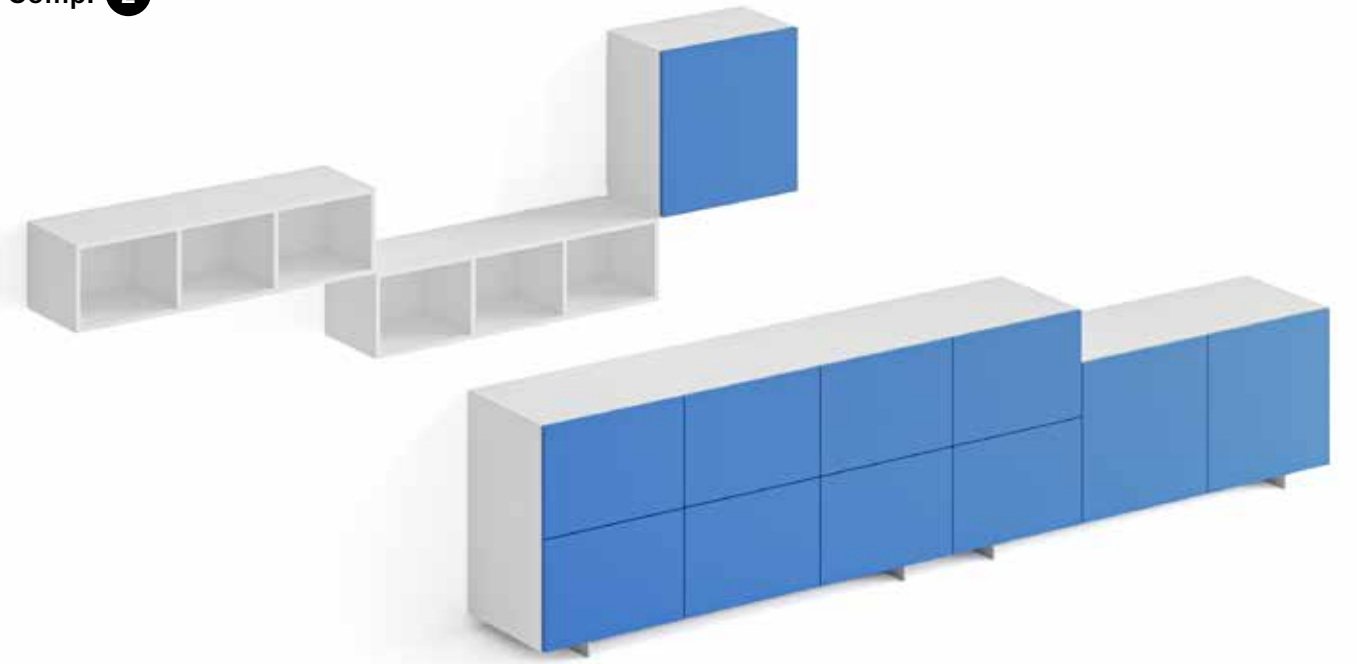

Esempi di composizioni /
Composition examples

Comp. 3



* Posizionamento consigliato barra a muro per allineamento madie e pensili /
Recommended positioning of the wall bar to align cupboards and wall units

Comp. 4

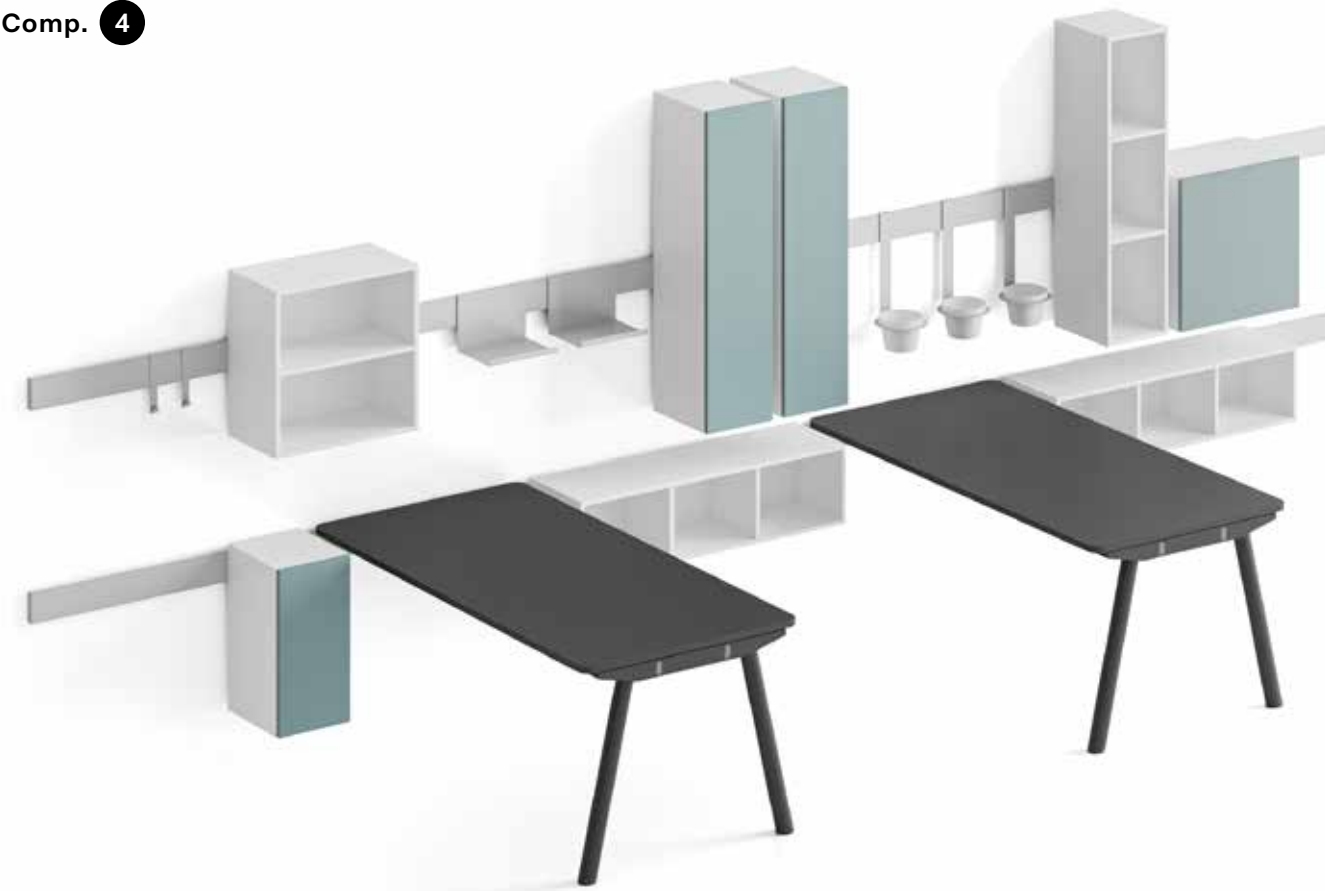

* * Posizionamento obbligatorio barra a muro con tavoli DV911 integrati /
Mandatory positioning of the wall bar with integrated DV911 tables

Moduli base/Modules

Scocche in melaminico sp. 1.8 cm, in folding/Folding melamine bodies 1.8 cm thick

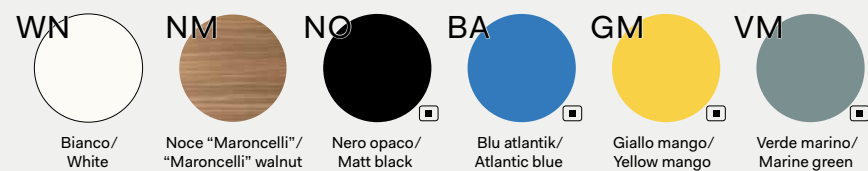

Ante, frontali cassetti e schiene di finitura in melaminico sp. 1.8 cm/Melamine doors, drawers front and finishing back panel 1.8 cm thick



Moduli superiori sp. 1 cm /Wall modules 1 cm thick

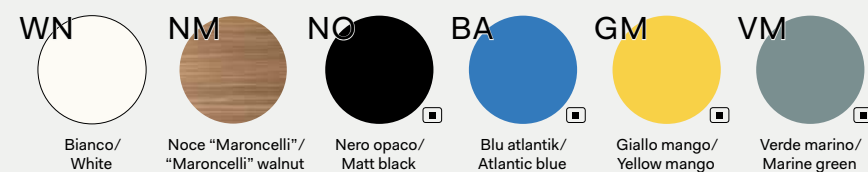

Cassetto interno / Internal drawer (Optional)



Top Access / Top Access

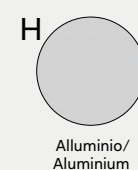

Barra/Bar

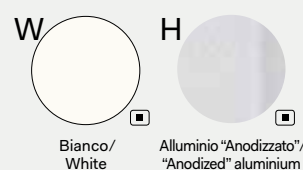

Accessori / Accessories

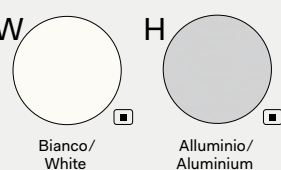

Vaso / Vase

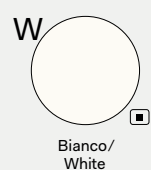

Zoccoli metallici/Metal base frames

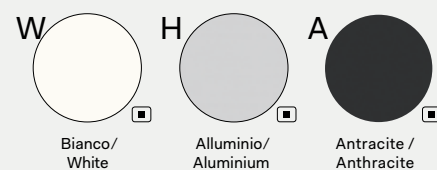

Zoccoli in melaminico / Melamine base frame

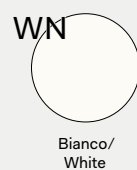

Tavolo scrivania orientabile / Swivel table



Note: Prodotti non in pronta consegna. Per la disponibilità contattare l'ufficio commerciale/Items not in prompt delivery. Please contact the commercial department to check availability.

Moduli base a giorno/Open modules

L 60 P 48 x H 40 L 120 P 48 x H 40 L 60 P 48 x H 60 L 120 P 48 x H 60 L 60 P 48 x H 120



Moduli base con ante/Modules with doors

L 60 P 50 x H 40 L 120 P 50 x H 40 L 60 P 50 x H 60 L 120 P 50 x H 60 L 60 P 50 x H 120

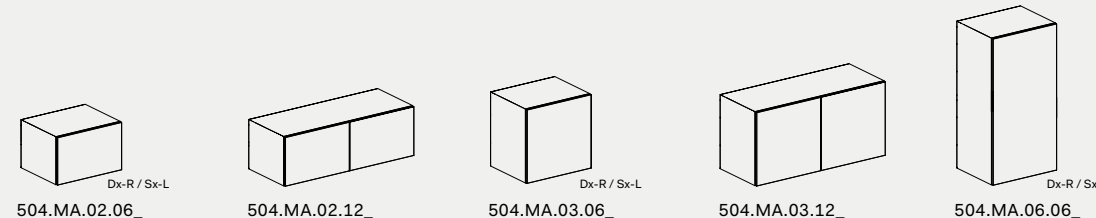

Moduli base con cassetti/Modules with drawers

L 60 P 50 x H 40 L 120 P 50 x H 40 L 60 P 50 x H 60 L 60 P 50 x H 60 L 120 P 50 x H 60

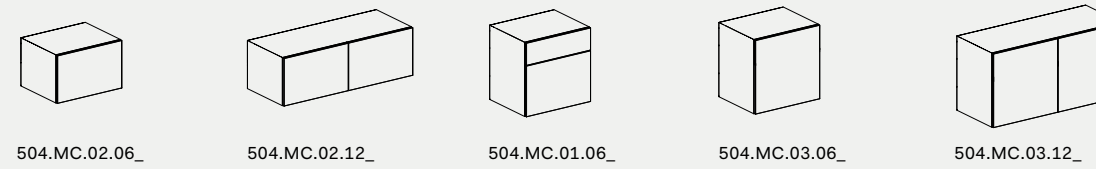

Accessori moduli base con cassetti/Accessories for modules with drawers

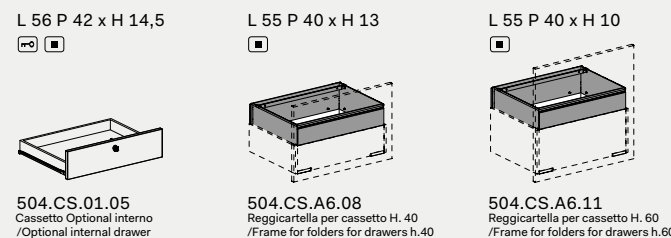

Accessori cassetti/Accessories for drawers

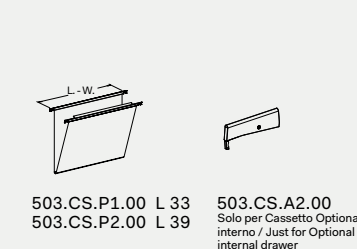

Note: Per l'integrazione degli accessori con i moduli con cassetti consultare il manuale tecnico/It is obligatory to integrate at least 1 back panel (internal or internal + external finishing panel) each two columns

Moduli con vano tecnico per integrazione tavoli/Modules with technical compartment for desk integration

L 60 P 50 x H 40 L 60 P 50 x H 40 L 60 P 50 x H 60 L 60 P 50 x H 60 L 60 P 50 x H 60 L 60 P 50 x H 60

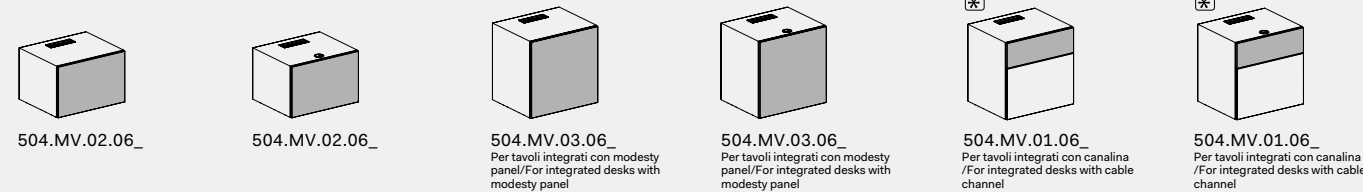

Con ante / With door

Note: Per la scelta degli accessori vari, consultare il relativo listino o catalogo/To choose accessories, please check correspondent price list or catalogue; Con serratura/With lock. Prodotti non in pronta consegna. Per la disponibilità contattare l'ufficio commerciale/Items not in prompt delivery. Please contact the commercial department to check availability; Le dimensioni sono espresse in cm - consultare il listino prezzi per le caratteristiche tecniche, i codici degli articoli e delle finiture/Dimensions are stated in cm - for technical characteristics, article code numbers and finishing see price list.

Barra/Bar



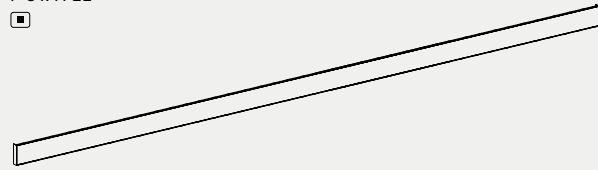





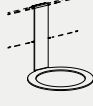

P 3 x H 11

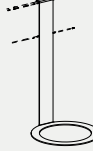
504.BR.01.18_L 180
 504.BR.01.24_L 240

Note: Disponibile in versione con o senza LED (IT-UK-US), chiedere all'ufficio commerciale/ Available with or without LED (IT-UK-US), contact the commercial department.
 Alla barra è possibile integrare gli accessori, i pensili e i tavoli scrivania della serie DV812-DV911/ It is possible to integrate to the bar the accessories, the overhead unit ante the desk tables of DV812-DV911 series

Accessori barra/Accessories for bar

<p>L 20 P 22 x H 20 </p>  <p>504.AC.01.01_ Porta vasi / Vase Holder</p>	<p>L 20 P 22 x H 40 </p>  <p>504.AC.01.02_ Porta vasi / Vase Holder</p>	<p>Ø 18 </p>  <p>504.AC.04.01 Vaso / Vase</p>	<p>L 3 P 4 x H 10 </p>  <p>504.AC.02.01_ Gancio / Hook</p>	<p>L 3 P 4 x H 20 </p>  <p>504.AC.02.02_ Gancio / Hook</p>	<p>L 30 P 21 x H 20 </p>  <p>504.AC.03.01_ Porta Fogli / Paper holder</p>
--	---	---	--	--	--

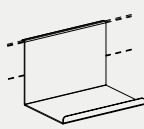

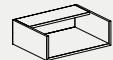
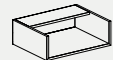
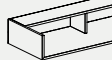
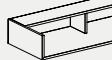
Moduli superiori/Superior module

<p>L 60 P 48 x H 20 </p>  <p>504.MS.00.06_</p>	<p>L 120 P 48 x H 20 </p>  <p>504.MS.00.12_</p>
---	--

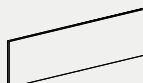
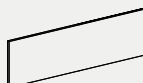
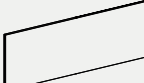
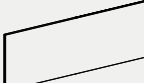
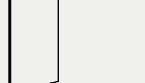
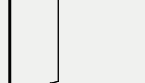
Schiene di finitura/Finishing back panel

<p>P 1.8 x H 40 </p>  <p>504.SC.02.06_L 60 504.SC.02.12_L 120 504.SC.02.18_L 180</p>	<p>P 1.8 x H 60 </p>  <p>504.SC.03.06_L 60 504.SC.03.12_L 120 504.SC.03.18_L 180</p>	<p>P 1.8 x H 120 </p>  <p>504.SC.06.06_L 60</p>
---	---	--

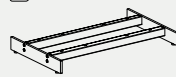

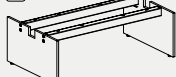
Zoccoli/Base frames

<p>P 48 - H 6,1 </p>  <p>504.ZB.01.12_L 80 504.ZB.01.18_L 140 504.ZB.01.24_L 200</p>	<p>P 48 - H 26,1 </p>  <p>504.ZB.02.12_L 80 504.ZB.02.18_L 140 504.ZB.02.24_L 200 Compresa coppia carter di copertura /Including pair of covering carters</p>
---	--

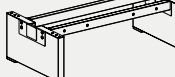





Zoccoli in melaminico / Melamine base frames

<p>P 48 - H 26,1 </p>  <p>504.ZB.03.12_L 80 504.ZB.03.18_L 140 504.ZB.03.24_L 200 Compresa coppia carter di copertura /Including pair of covering carters</p>
--

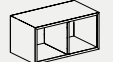
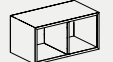
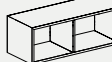
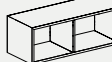
Canalina per zoccoli / Wire management for base frames







<p>L 115 P 12 - H 2 </p>  <p>300.CL.01.40</p>
--

Modulo pensile/Overhead module

<p>L 60 P 34 x H 30 </p>  <p>504.PG.01.06_</p>	<p>L 120 P 34 x H 30 </p>  <p>504.PG.01.12_</p>	<p>L 30 P 34 x H 60 </p>  <p>504.PG.03.03_</p>	<p>L 60 P 34 x H 60 </p>  <p>504.PG.03.06_</p>	<p>L 30 P 34 x H 120 </p>  <p>504.PG.06.03_</p>
---	--	---	---	--

Note: Pensili integrabili alla barra o a parete/Overhead for integration to bar or wall

Modulo pensile con ante/Overhead module with doors

<p>L 30 P 36 x H 60 </p>  <p>504.PA.03.03_</p>	<p>L 60 P 36 x H 60 </p>  <p>504.PA.03.06_</p>	<p>L 30 P 36 x H 120 </p>  <p>504.PA.06.03_</p>
---	---	--

Note: Pensili integrabili alla barra o a parete/Overhead for integration to bar or wall

Tavolo scrivania orientabile/Swivel desk

L 160 P 50 x H 74

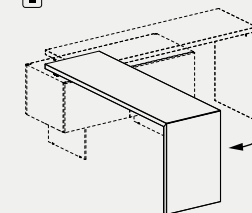

504.TH.00.16_

Note: I tavoli orientabili possono essere integrati solo ai moduli base con ante o cassetti DV504 / N.B.: The swivel desks can only be integrated with the base modules with doors or drawers DV504

Note:

1 Per la scelta degli accessori vari, consultare il relativo listino o catalogo/To choose accessories, please check correspondent price list or catalogue;

2 Prodotti non in pronta consegna. Per la disponibilità contattare l'ufficio commerciale/Items not in prompt delivery. Please contact the commercial department to check availability;

2 Le dimensioni sono espresse in cm - consultare il listino prezzi per le caratteristiche tecniche, i codici degli articoli e delle finiture/Dimensions are stated in cm - for technical characteristics, article code numbers and finishing see price list.

Note:

1 Per la scelta degli accessori vari, consultare il relativo listino o catalogo/To choose accessories, please check correspondent price list or catalogue;

2 Prodotti non in pronta consegna. Per la disponibilità contattare l'ufficio commerciale/Items not in prompt delivery. Please contact the commercial department to check availability;

2 Le dimensioni sono espresse in cm - consultare il listino prezzi per le caratteristiche tecniche, i codici degli articoli e delle finiture/Dimensions are stated in cm - for technical characteristics, article code numbers and finishing see price list.

DV505 Rio

Design:
Antonio Morello

IT I “contenitori integrati” permettono di completare e di attrezzare il posto di lavoro, garantendo diverse funzioni, quali: ampio spazio per il contenimento e l'archiviazione, utile predisposizione ed efficiente canalizzazione dei cablaggi, possibilità di creare molteplici soluzioni in grado di configurare lo spazio di lavoro con privacy e personalizzazione.

EN The “integrated storage units” make possible to complete and equip the workplace, ensuring various functions including: wide space for organization and storage, useful predisposition and efficient wiring of the cables, possibility of creating multiple solutions able to configure the workplace with privacy and customization.





Contenitori integrati / Integrated storage units

Altezza	Height	Larghezza	Width	Profondità	Depth
A - 74 cm	H - 29 1/4"	L - 166.5 cm	W - 65 1/2"	P - 48 cm	D - 18 3/4"
A - 115 cm	H - 45 1/4"				
A - 164.5 cm	H - 64 3/4"				

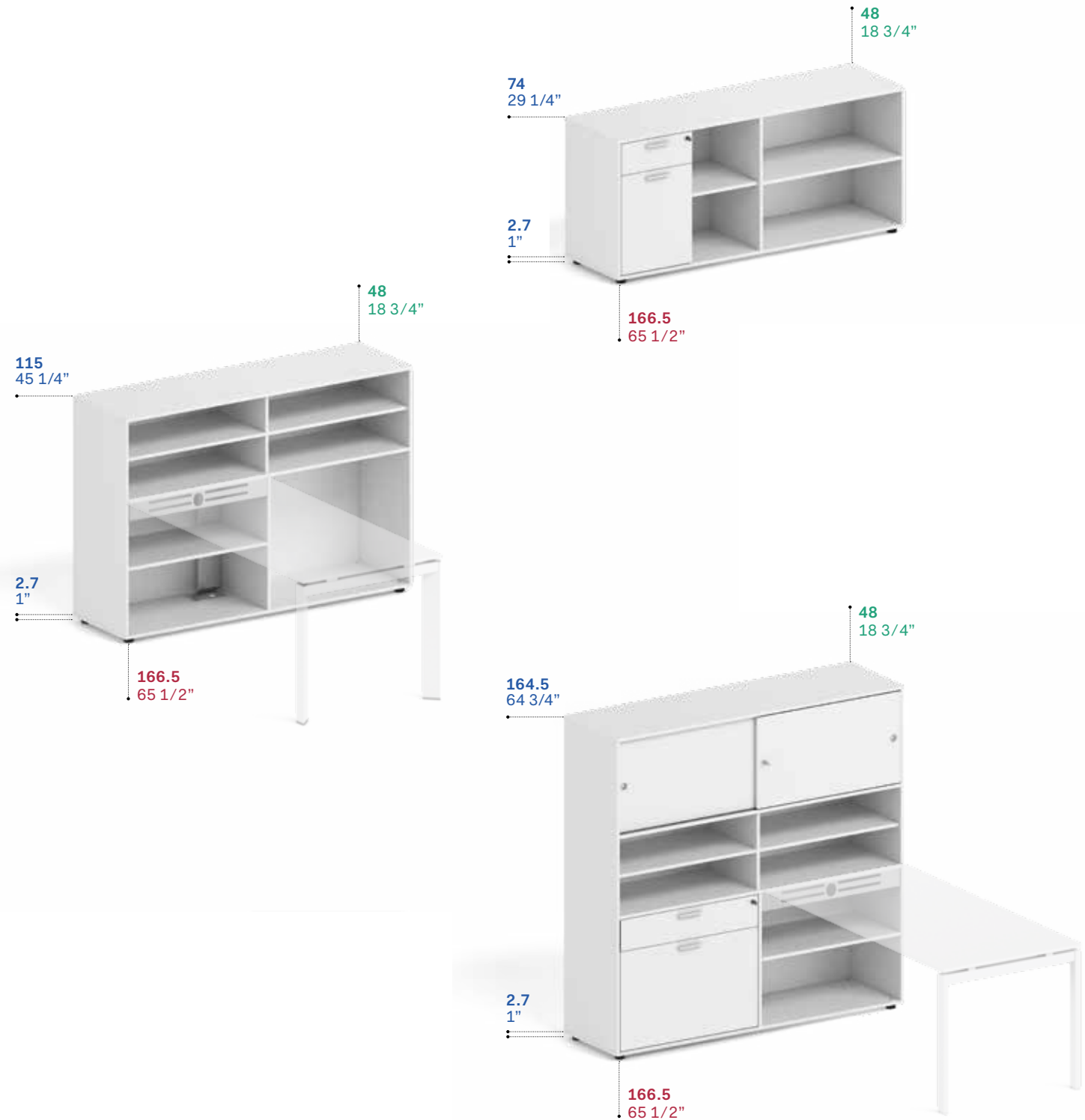

Moduli contenitori integrabili / Integrated storage units

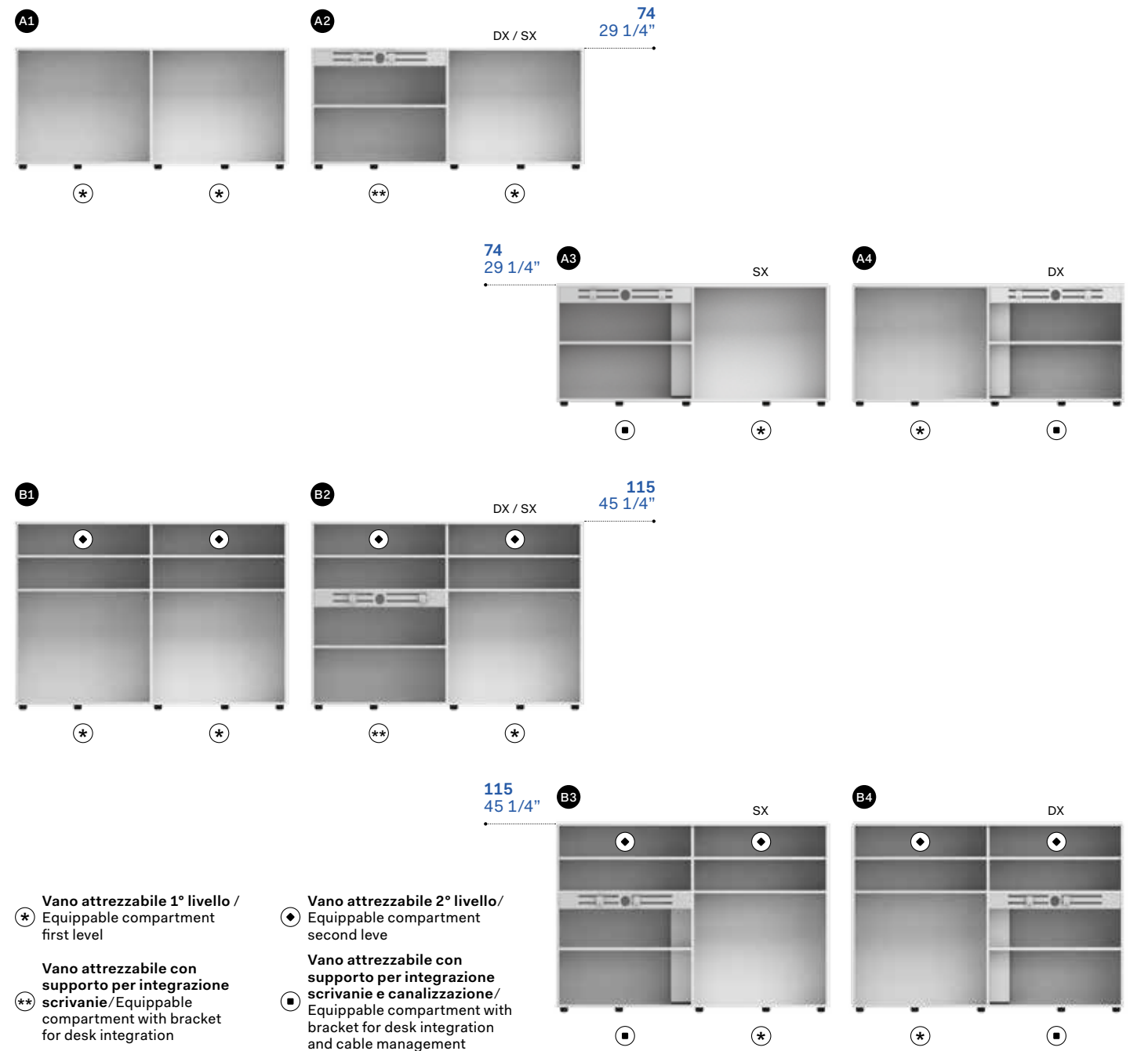

Altezza	Height	Larghezza	Width	Profondità	Depth
A - 74 cm	H - 29 1/4"	L - 166.5 cm	W - 65 1/2"	P - 48 cm	D - 18 3/4"
A - 115 cm	H - 45 1/4"				

- A1 B1** Contenitore Basso e Medio con 2 vani attrezzabili / Low and Medium storage unit with 2 equipppable compartments
- A2 B2** Contenitore Basso e Medio con 1 vano attrezzabile e supporto integrazione scrivania / Low and Medium storage unit with 1 equipppable compartment and bracket for desk integration
- A3 B3** Contenitore Basso e Medio con 1 vano attrezzabile, canalizzazione SX e supporto integrazione scrivania / Low e Medium storage unit with 1 equipppable compartment, left wire management and bracket for desk integration
- A4 B4** Contenitore Basso e Medio con 1 vano attrezzabile, canalizzazione DX e supporto integrazione scrivania / Low e Medium storage unit with 1 equipppable compartment, right wire management and bracket for desk integration







- * Vano attrezzabile 1° livello / Equipppable compartment first level**
- ** Vano attrezzabile con supporto per integrazione scrivanie / Equipppable compartment with bracket for desk integration**
- ◐ Vano attrezzabile 2° livello / Equipppable compartment second leve**
- ◑ Vano attrezzabile con supporto per integrazione scrivanie e canalizzazione / Equipppable compartment with bracket for desk integration and cable management**

Moduli contenitori integrabili / Integrated storage units

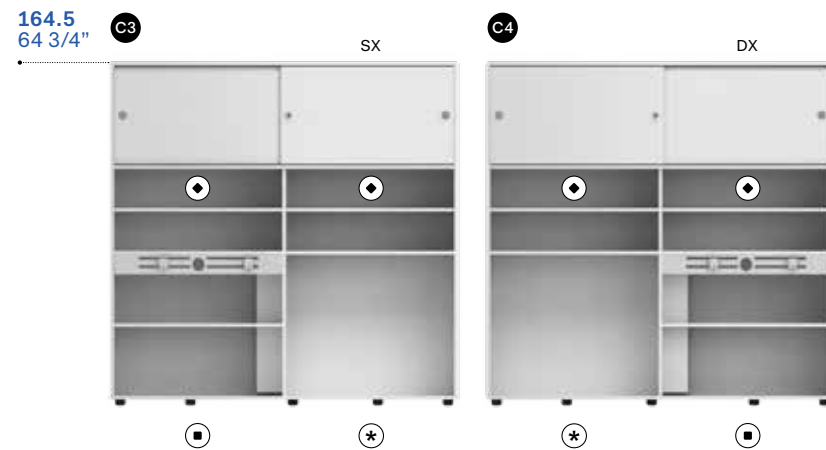
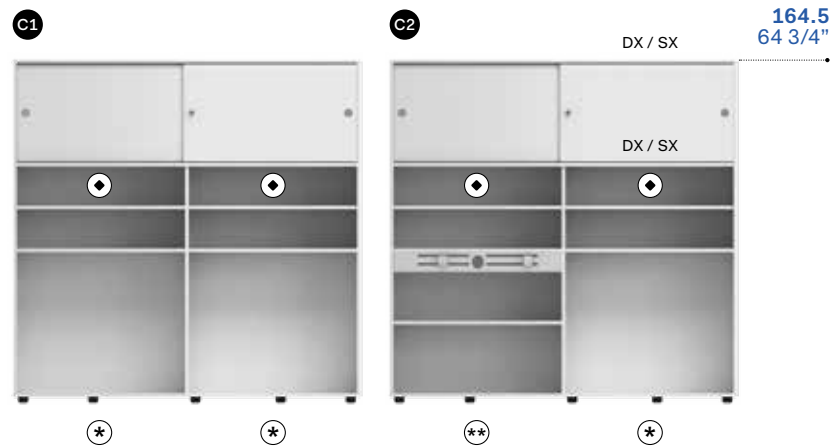

Altezza	Height		Larghezza	Width		Profondità	Depth	
A - 164.5 cm	H - 64 3/4"		L - 166.5 cm	W - 65 1/2"		P - 48 cm	D - 18 3/4"	

- C1** Contenitore alto con 2 vani attrezzabili / High storage unit with 2 equipppable compartments
- C2** Contenitore alto con 1 vano attrezzabile e supporto integrazione scrivania / High storage unit with 1 equipppable compartment and bracket for desk integration
- C3** Contenitore alto con 1 vano attrezzabile, canalizzazione SX e supporto integrazione scrivania / High storage unit with 1 equipppable compartment, left wire management and bracket for desk integration
- C4** Contenitore alto con 1 vano attrezzabile, canalizzazione DX e supporto integrazione scrivania / High storage unit with 1 equipppable compartment, right wire management and bracket for desk integration







-  Vano attrezzabile 1° livello / Equipppable compartment first level
-  Vano attrezzabile 2° livello / Equipppable compartment second level
-  Vano attrezzabile con supporto per integrazione scrivanie / Equipppable compartment with bracket for desk integration
-  Vano attrezzabile con supporto per integrazione scrivanie e canalizzazione / Equipppable compartment with bracket for desk integration and cable management

Moduli contenitori integrabili - versione a giorno / Integrated storage units - open units

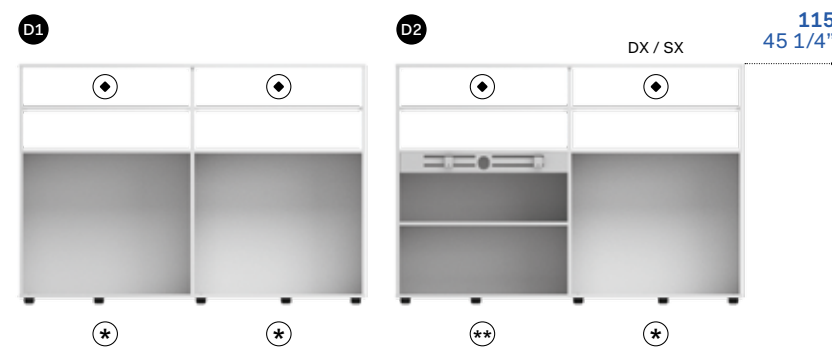
Altezza	Height		Larghezza	Width		Profondità	Depth	
A - 115 cm	H - 45 1/4"		L - 166.5 cm	W - 65 1/2"		P - 48 cm	D - 18 3/4"	

- D1** Contenitore Medio con 2 vani attrezzabili / Medium storage unit with 2 equipppable compartments
- D2** Contenitore Medio con 1 vano attrezzabile e supporto integrazione scrivania / Medium storage unit with 1 equipppable compartment and bracket for desk integration
- D3** Contenitore Medio con 1 vano attrezzabile, canalizzazione SX e supporto integrazione scrivania / Medium storage unit with 1 equipppable compartment, left wire management and bracket for desk integration
- D4** Contenitore Medio con 1 vano attrezzabile, canalizzazione DX e supporto integrazione scrivania / Medium storage unit with 1 equipppable compartment, right wire management and bracket for desk integration



-  Vano attrezzabile 1° livello / Equipppable compartment first level
-  Vano attrezzabile 2° livello / Equipppable compartment second level
-  Vano attrezzabile con supporto per integrazione scrivanie / Equipppable compartment with bracket for desk integration
-  Vano attrezzabile con supporto per integrazione scrivanie e canalizzazione / Equipppable compartment with bracket for desk integration and cable management

**Moduli contenitori integrabili – versione a giorno /
Integrated storage units – open units**

Altezza	Height	Larghezza	Width	Profondità	Depth
A – 164.5 cm	H – 64 3/4"	L – 166.5 cm	W – 65 1/2"	P – 48 cm	D – 18 3/4"

- E1** Contenitore Alto con 2 vani attrezzabili / High storage unit with 2 equippable compartments
- E2** Contenitore Alto con 1 vano attrezzabile e supporto integrazione scrivania / High storage unit with 1 equippable compartment and bracket for desk integration
- E3** Contenitore Alto con 1 vano attrezzabile, canalizzazione SX e supporto integrazione scrivania / High storage unit with 1 equippable compartment, left wire management and bracket for desk integration
- E4** Contenitore Alto con 1 vano attrezzabile, canalizzazione DX e supporto integrazione scrivania / High storage unit with 1 equippable compartment, right wire management and bracket for desk integration

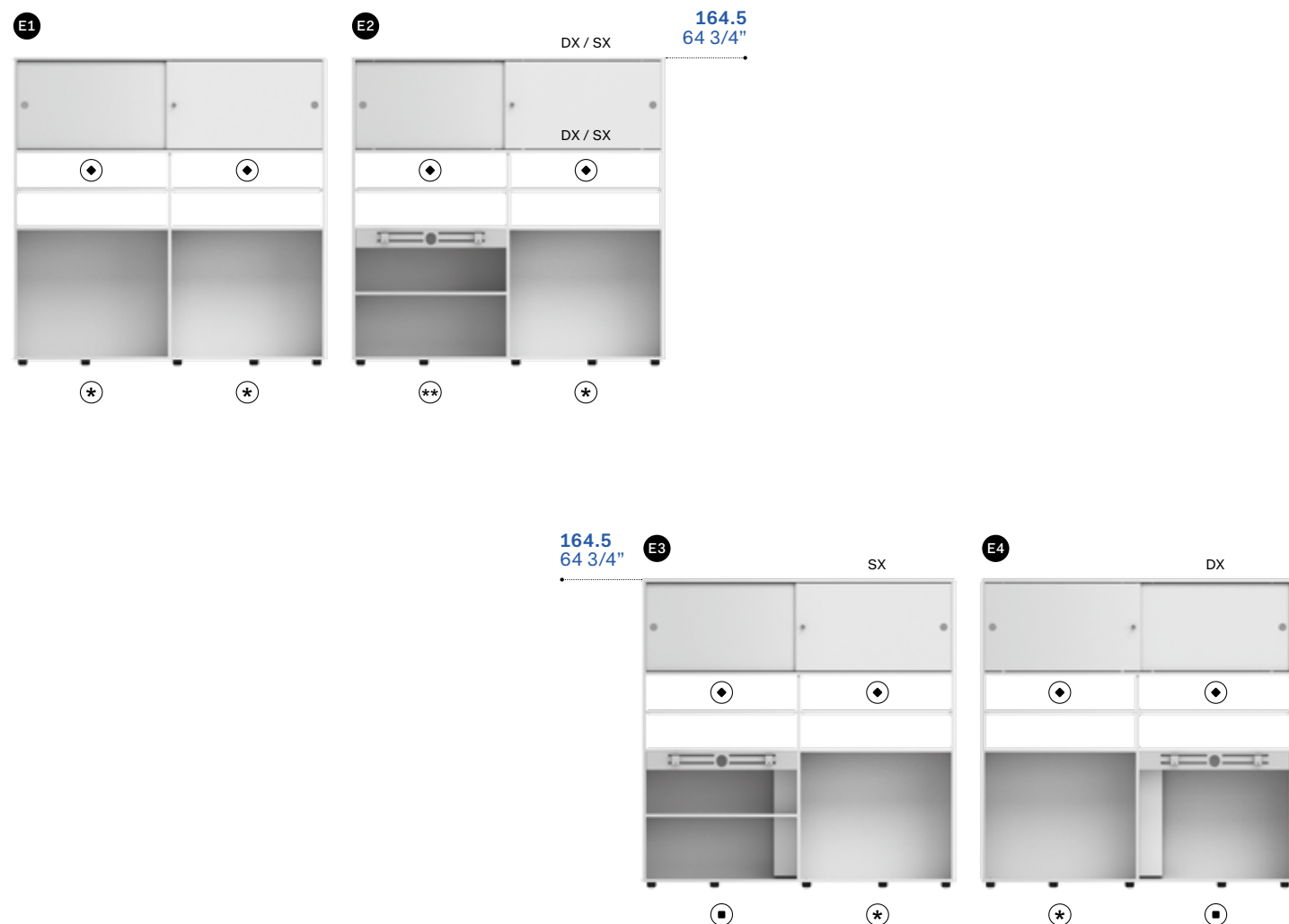

- ⊛ Vano attrezzabile 1° livello / Equippable compartment first level
- ⊙ Vano attrezzabile 2° livello / Equippable compartment second level
- ⊛ Vano attrezzabile con supporto per integrazione scrivanie / Equippable compartment with bracket for desk integration
- ⊙ Vano attrezzabile con supporto per integrazione scrivanie e canalizzazione / Equippable compartment with bracket for desk integration and cable management

**Accessori per contenitori /
Accessories for storage units**

Description	Altezza	Height	Larghezza	Width	Profondità	Depth
A1 Cassettiera / Drawers	A – 67.5 cm	H – 26 2/4"	L – 41.5 cm	W – 16 1/4"	P – 45,8 cm	D – 18"
A2 Cassettiera / Drawers	A – 67.5 cm	H – 26 2/4"	L – 80 cm	W – 31 2/4"		

- A1 A2** Cassettiera 2 cassetti per contenitore interno / 2 drawers pedestal for unit

- B1 B2 B3 B4** Ripiano / Shelf

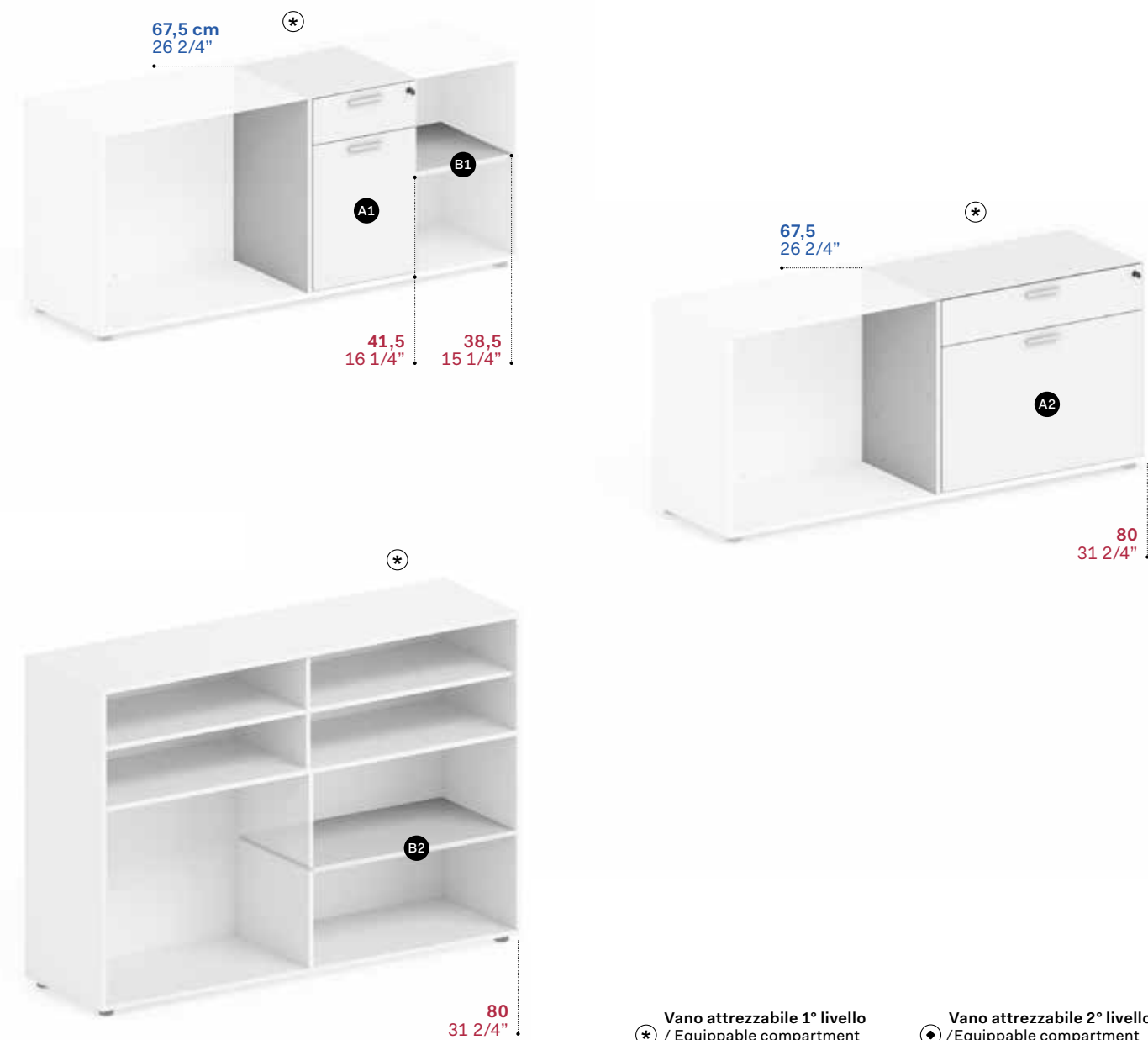

- ⊛ Vano attrezzabile 1° livello / Equippable compartment first level
- ⊙ Vano attrezzabile 2° livello / Equippable compartment second level
- ⊛ Vano attrezzabile con supporto per integrazione scrivanie / Equippable compartment with bracket for desk integration
- ⊙ Vano attrezzabile con supporto per integrazione scrivanie e canalizzazione / Equippable compartment with bracket for desk integration and cable management

Accessori per contenitori /
Accessories for storage units

Description	Altezza Height	Larghezza Width	Profondità Depth
B1 Ripiano / Shelf	A - 1.8 cm H - 3/4"	L - 38.5 cm W - 15 1/4"	P - 44 cm D - 17 1/4"
B2 Ripiano / Shelf	A - 1.8 cm H - 3/4"	L - 80 cm W - 31 2/4"	P - 45.5 cm D - 18"
B3 Ripiano / Shelf	A - 1.8 cm H - 3/4"	L - 80 cm W - 31 2/4"	P - 42 cm D - 16 2/4"
B4 Ripiano / Shelf	A - 1.8 cm H - 3/4"	L - 80 cm W - 31 2/4"	P - 43.8 cm D - 17 1/4"

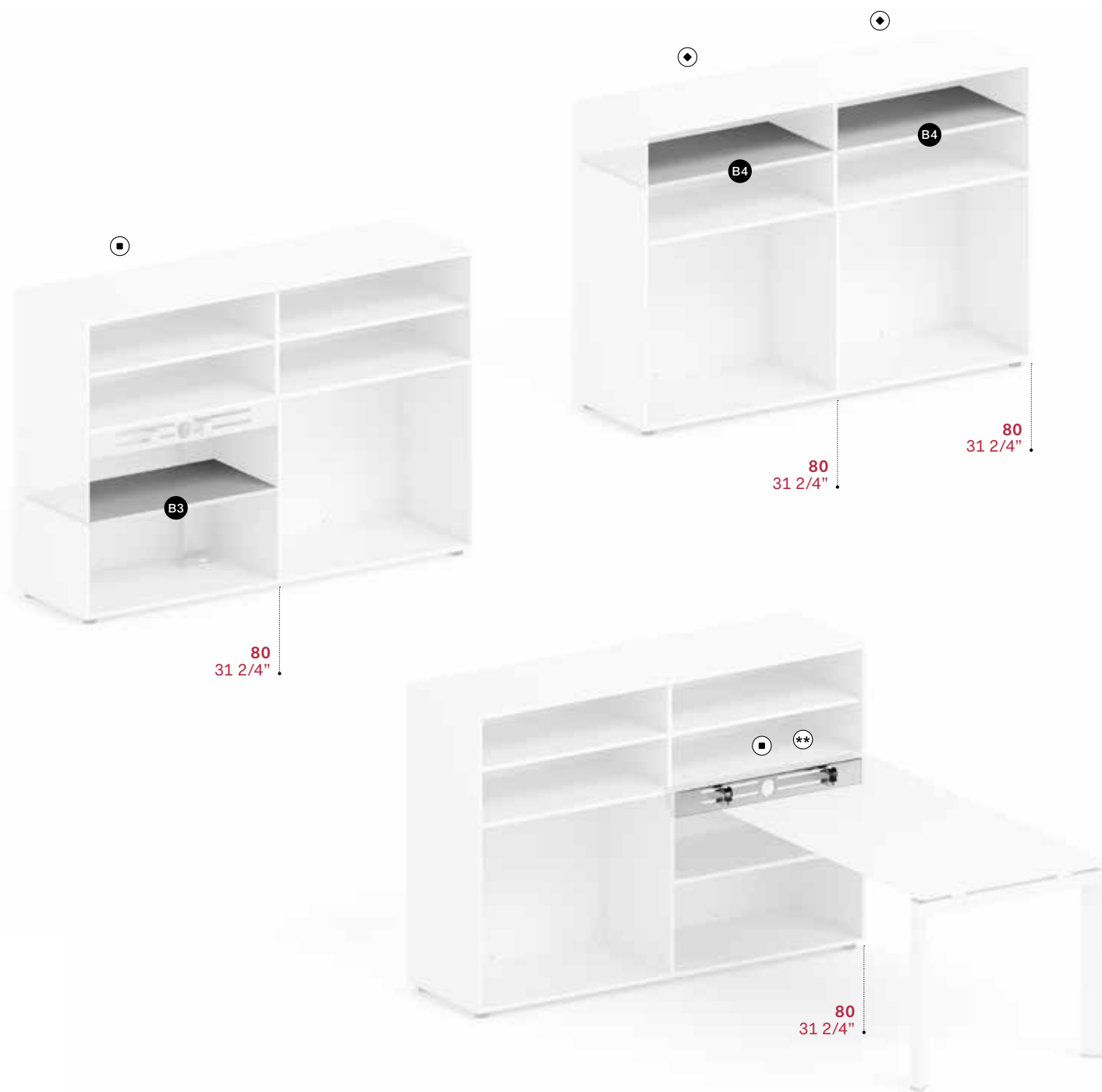

Note: È possibile integrare ai contenitori con supporto scrivania le serie DV801-DV802 / DV801-DV802 series can be integrated to the orgatowers with desk support bracket. Per l'integrazione della serie DV812, vedi relativo catalogo / For the integration of the DV812 series, see its catalog.

Capacità ripiani - Dox /
Shelf storage capacity - Dox

1° Livello / 1° Level



18_{Dox}
L: 166.5 - W: 65 2/4"

2° Livello / 2° Level



36_{Dox}
L: 166.5 - W: 65 2/4"

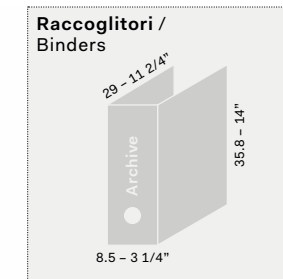

3° Livello / 3° Level



54_{Dox}
L: 166.5 - W: 65 2/4"

Portata ripiani /
Shelf carrying capacity

30 KG



Portata ripiani L: 80 cm - 30 kg /
W: 1 2/4" shelf carrying capacity 66 lbs

Portata max di ogni contenitore 200 kg /
Maximum carrying capacity of each storage unit is 441 lbs

Capacità cassettiere – Cartelle /
Drawers storage capacity – Folders

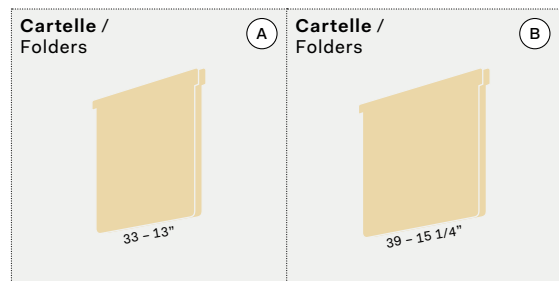

L: 41.5 – W: 16 1/4"

L: 41.5 – W: 16 1/4"

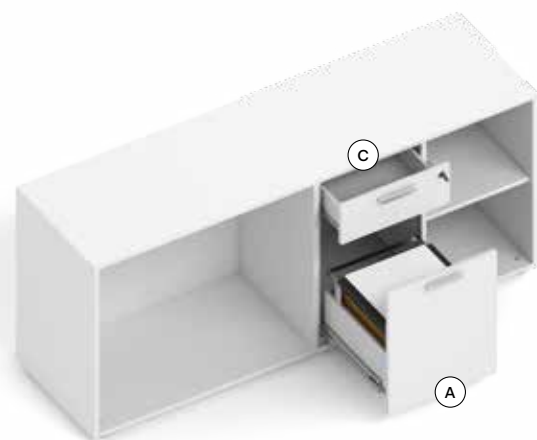

22 Cartelle /
Folders (A)

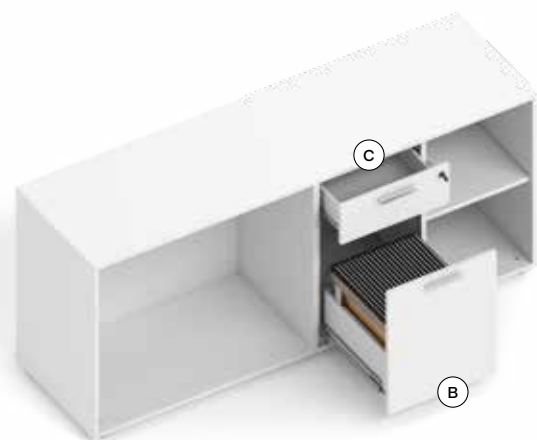

25 Cartelle /
Folders (B)

L: 80 – W: 31 2/4"

L: 80 – W: 31 2/4"



50 Cartelle /
Folders (A)



50 Cartelle /
Folders (B)

Canalizzazione /
Wire management

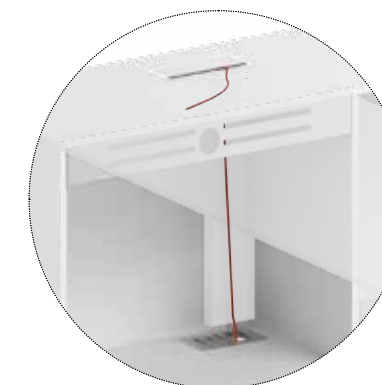
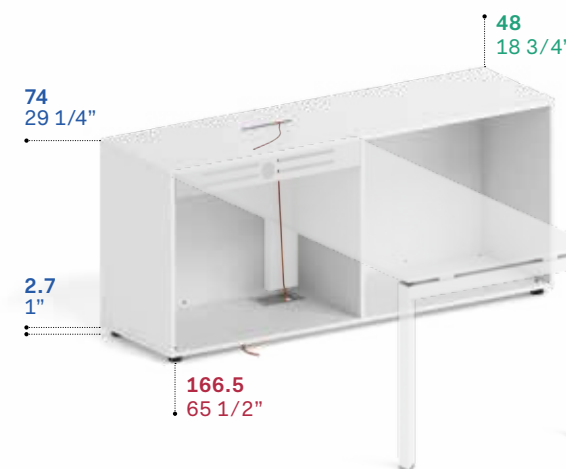
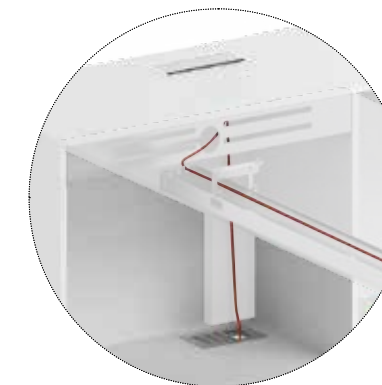
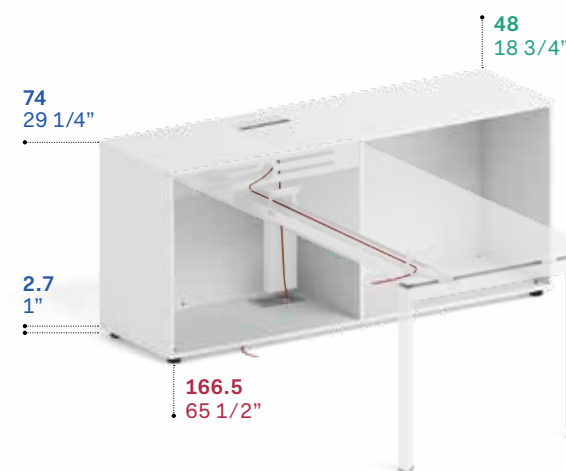

Note: È possibile aggiungere un top access al top-ripiano dei mobili contenitori integrati con canalizzazione. Chiedere all'ufficio commerciale. /
It is possible to add a top access to the top-shelf of the integrated storage units with wire channel. Contact the commercial department.

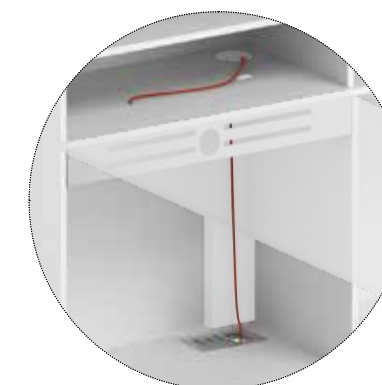
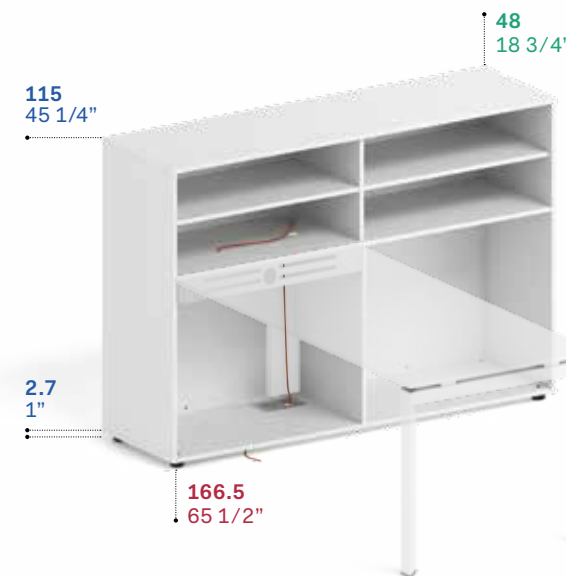

Note: È possibile aggiungere un tappo passacavi Ø 2 3/8" - 3 1/8" al top-ripiano dei mobili contenitori integrati con canalizzazione. Chiedere all'ufficio commerciale. /
It is possible to add an outlet lid Ø 2 3/8" - 3 1/8" at the top-shelf of the integrated storage units with wire channel. Contact the commercial department.

Esempi composizioni / Composition examples

- A1** Scocca 1° livello con 2 vani attrezzabili / Body 1° level with 2 compartments to be equipped
- A2** Cassettera L: 40 cm con ripiano / Drawer W: 15 3/4" with shelf
- A3** Ripiano L: 80 cm / Shelf W: 31 1/2"
- B1** Scocca 2° livello con canalizzazione lato SX ed un vano attrezzabile / Body 2° level with left side wire channel and compartment to be equipped
- B2** Ripiano per vano di 2° livello / Shelf for compartment 2° level
- B3** Tavolo scrivania serie DV801 / Desk DV801 series
- B4** Ripiano per modulo con canalizzazione / Shelf for module with wire channel
- C1** Scocca 3° livello con supporto per tavoli integrabili, e vano attrezzabile / Body 3° level with bracket for integrated desks and compartment to be equipped
- C2** Cassettera L: 80 cm / Pedestal W: 31 1/2"
- C3** Tavolo scrivania serie DV802 / Desk DV802 series
- C4** Ripiano per modulo attrezzabile / Shelf for module with wire channel
- C5** Ripiano per vano di 2° livello / Shelf for compartment 2° level

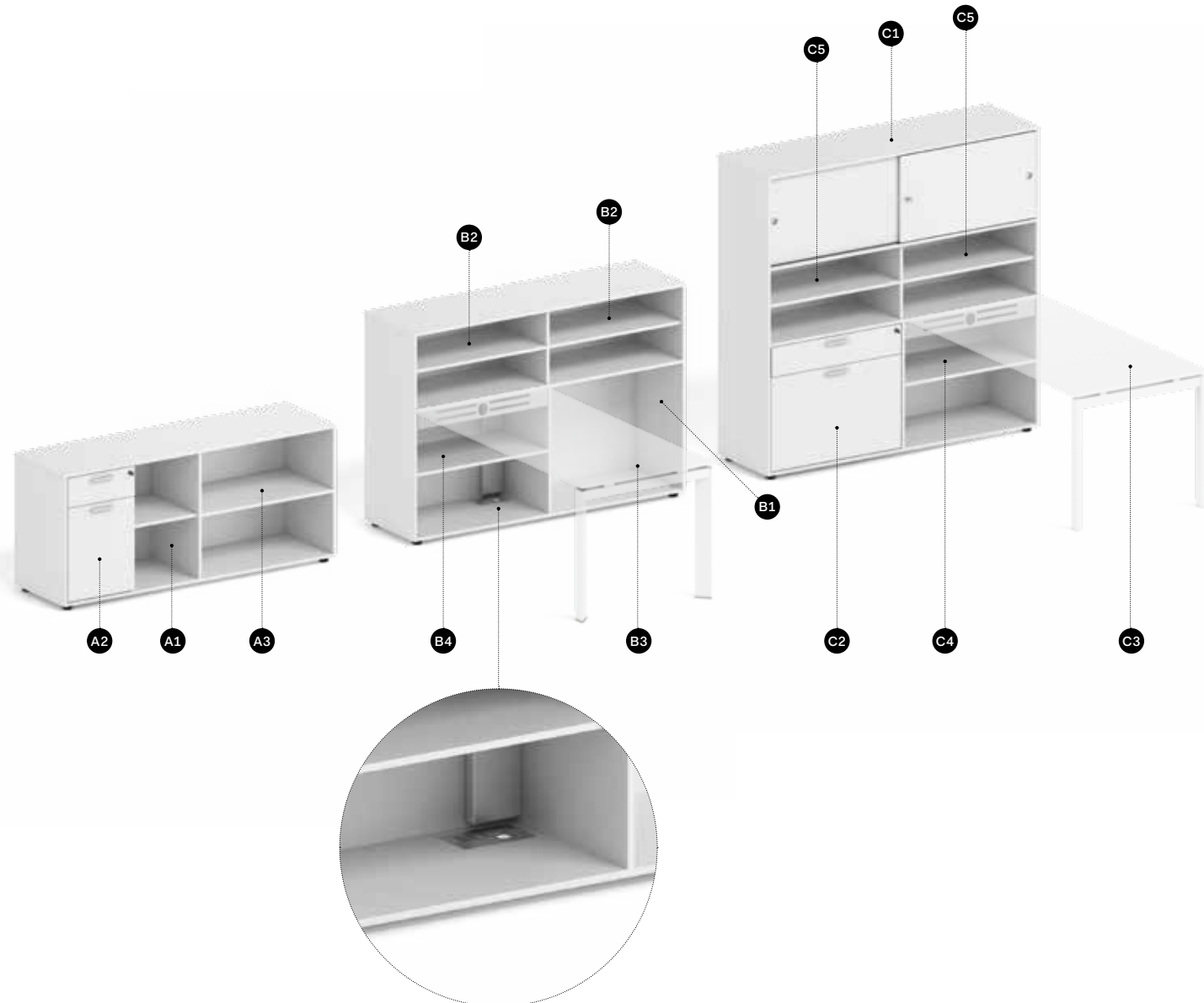

Orgatower – Cassettoni a estrazione totale del frontale / Orgatower – Drawers with total frontal extraction

Altezza	Height	Larghezza	Width	Profondità	Depth
A – 74 cm	H – 29 1/4"	L – 42 cm	W – 16 2/4"	P – 65 cm	D – 25 2/4"
A – 115 cm	H – 45 1/4"			P – 80 cm	D – 31 1/2"

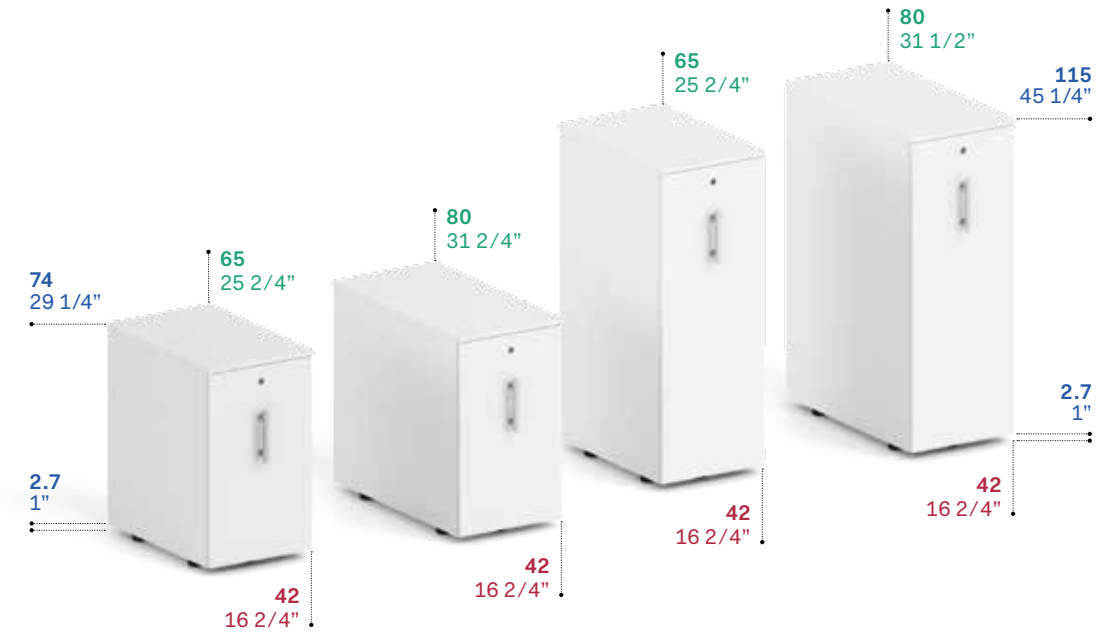

Orgatower – Staffa per ancoraggio (tavoli scrivania) / Orgatower – Linking bracket (desks)

- A1 A3** Staffa per ancoraggio Orgatower con piani e tavoli P: 65 cm – DV801 e DV802 / Linking bracket Orgatower with working tops and tables depth 25 2/4" – DV801 and DV802
- A2 A4** Staffa per ancoraggio Orgatower con piani e tavoli P: 80 cm – DV801 e DV802 / Linking bracket Orgatower with working tops and tables depth 31 2/4" – DV801 and DV802

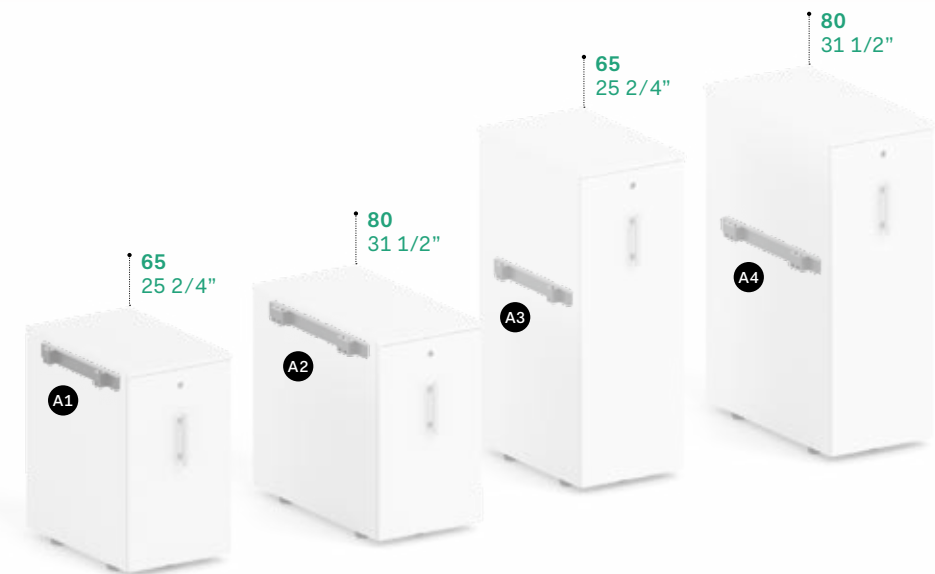

Note: Per l'integrazione della serie DV812, vedi relativo catalogo / For the integration of the DV812 series, see its catalog.

Portata Orgatower /
Carrying capacity Orgatower

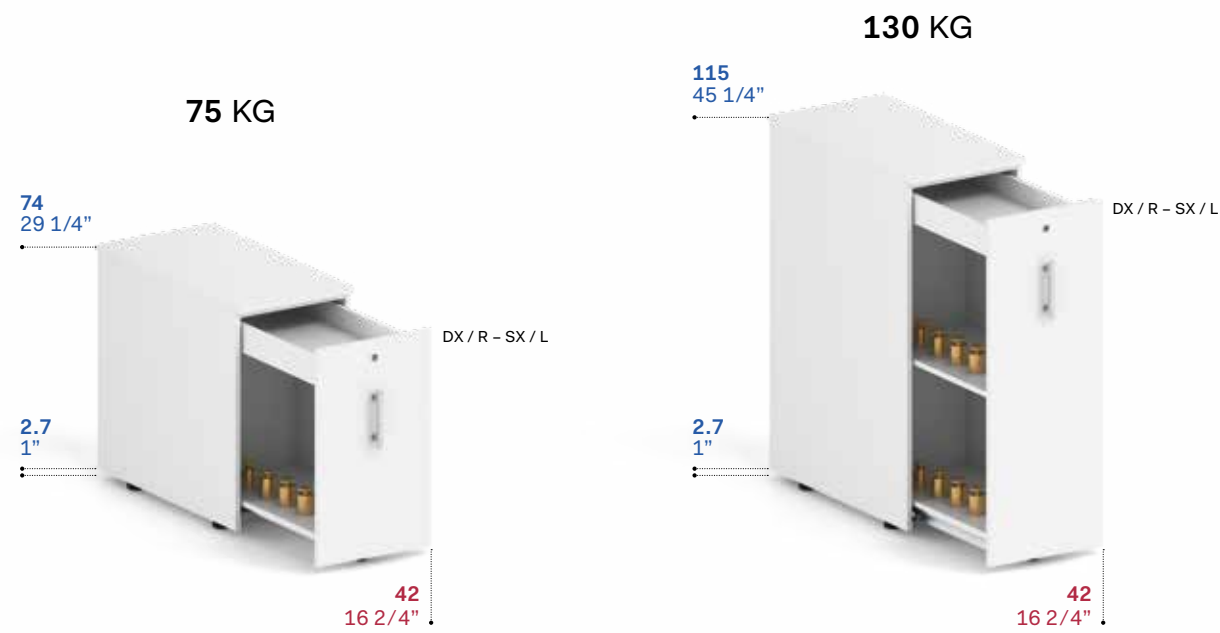

Capacità archiviazione raccoglitori (dox) /
Binders storage capacity (dox)

P: 65 - D: 25 2/4"

P: 80 - D: 31 2/4"

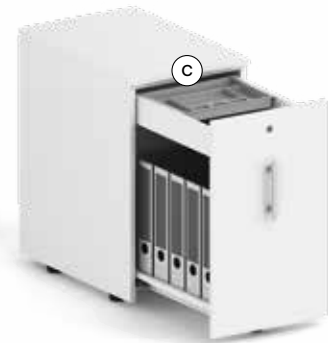

6 Dox

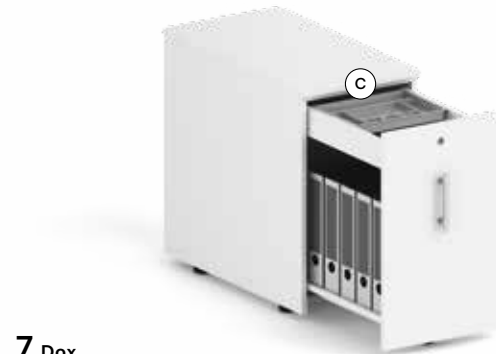

7 Dox

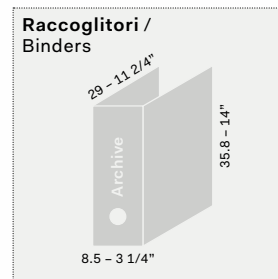

Accessori (Optional) /
Accessories (Optional)



P: 65 - D: 25 2/4"

P: 80 - D: 31 2/4"



12 Dox

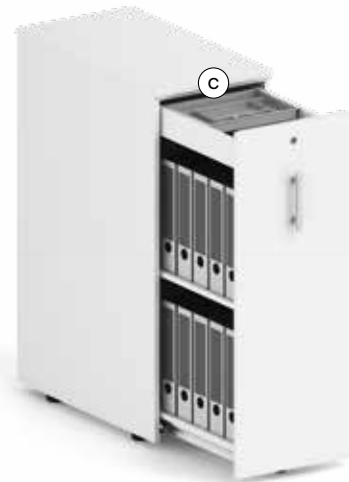

14 Dox

Orgatower

- A1** Orgatower
H: 115 cm - P: 65 cm /
Orgatower
H: 45 1/4" - D: 25 2/4"
- A2** Piani bench
P: 136,5 cm serie DV801 /
Bench worktops
D: 53 3/4" DV801 series
- A3** Gamba bench
P: 136,5 cm serie DV801 /
Bench leg
D: 53 3/4" DV801 series
- A4** Supporto per piani
P: 65 cm /
Linking bracket for
D: 25 2/4 worktops

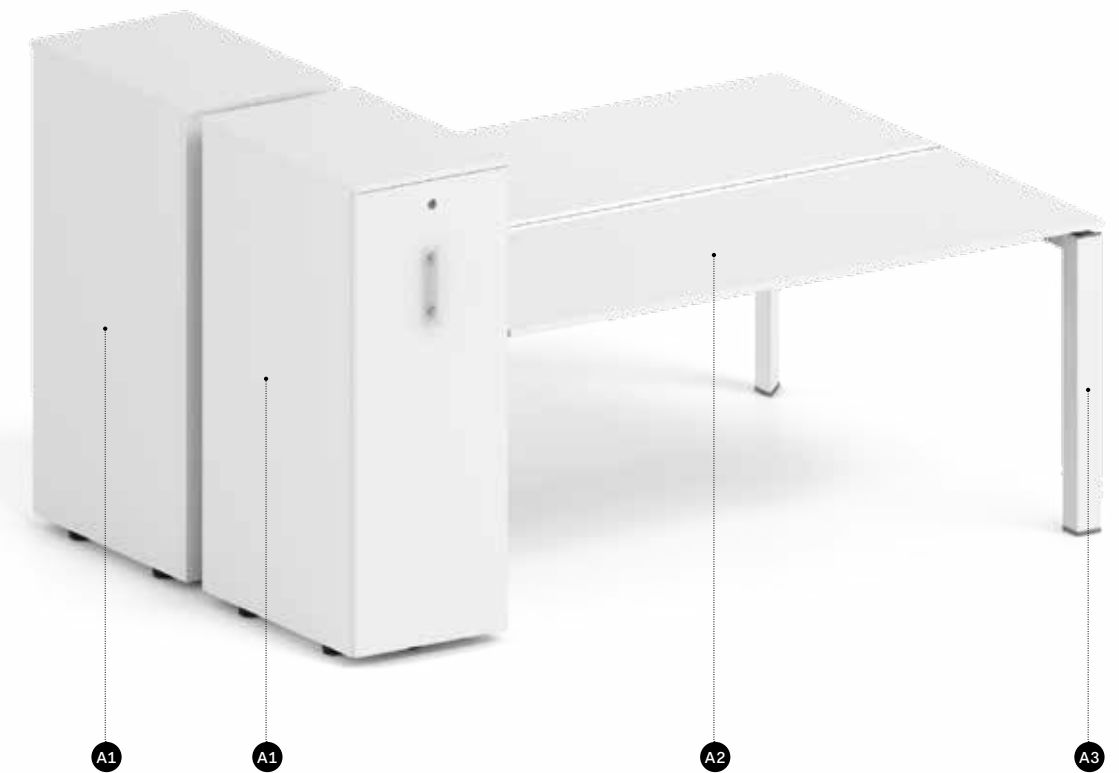

Orgatower

- B1** Contenitore con 1 vano attrezzabile, canalizzazione DX e supporto integrazione scrivania / Storage unit with 1 equipppable compartment, right wire management and bracket for desk integration
- B2** Piani scrivania P: 80 cm serie DV802 / Bench worktops D: 31 2/4" DV802 series
- B3** Orgatower H: 74 cm - P: 80 cm / Orgatower H: 29 1/4" - D: 31 2/4"
- B4** Supporto per piani P: 80 cm / Linking bracket for D: 31 2/4" worktops

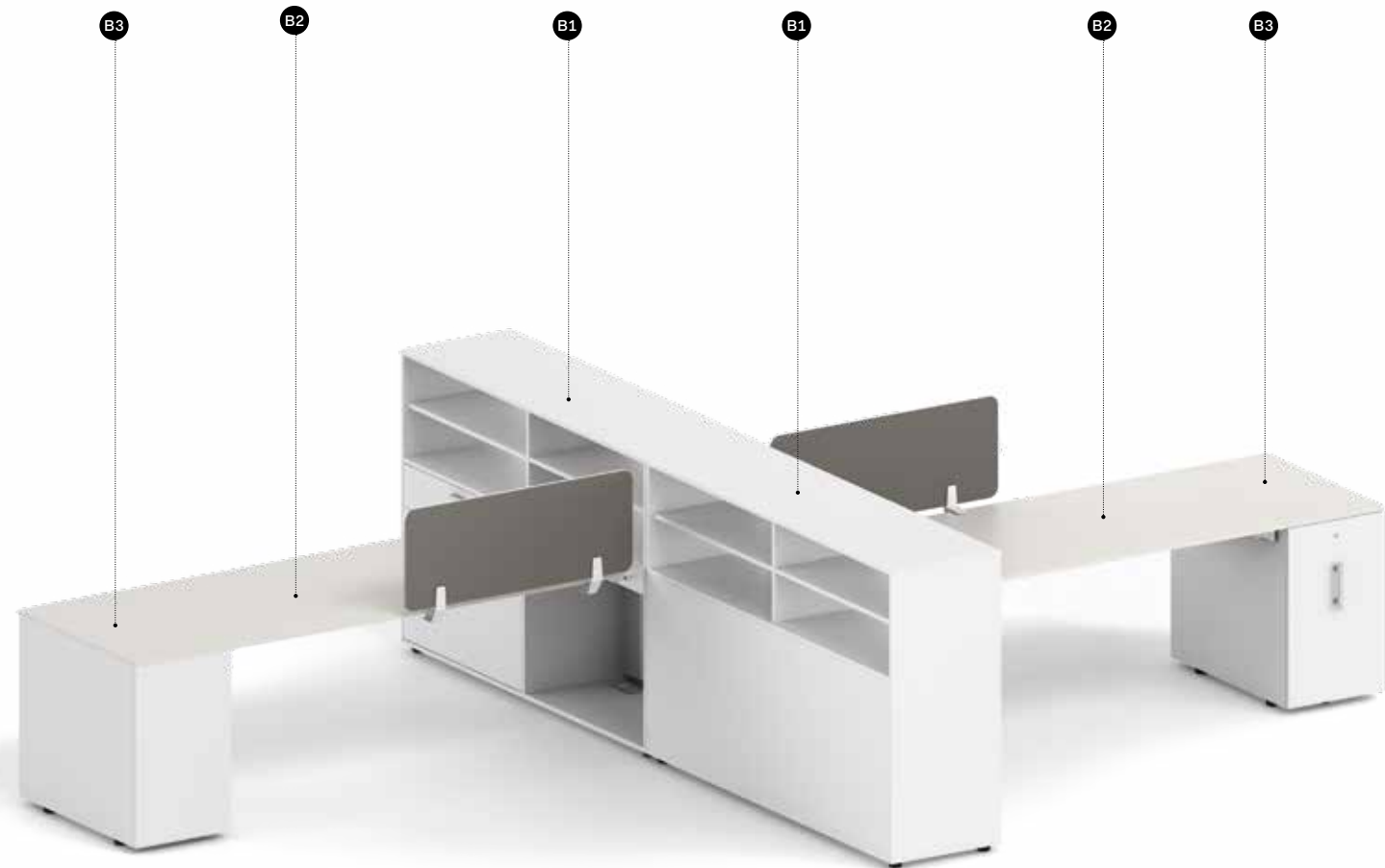

B4

Esempi di composizioni con DV802 / Composition examples with DV802

Comp. 1



Comp. 2



Esempi di composizioni con DV801 /
Composition examples with DV801

Comp. 3



Comp. 4



Esempi di composizioni con DV802 /
Composition examples with DV802

Comp. 5



Comp. 6

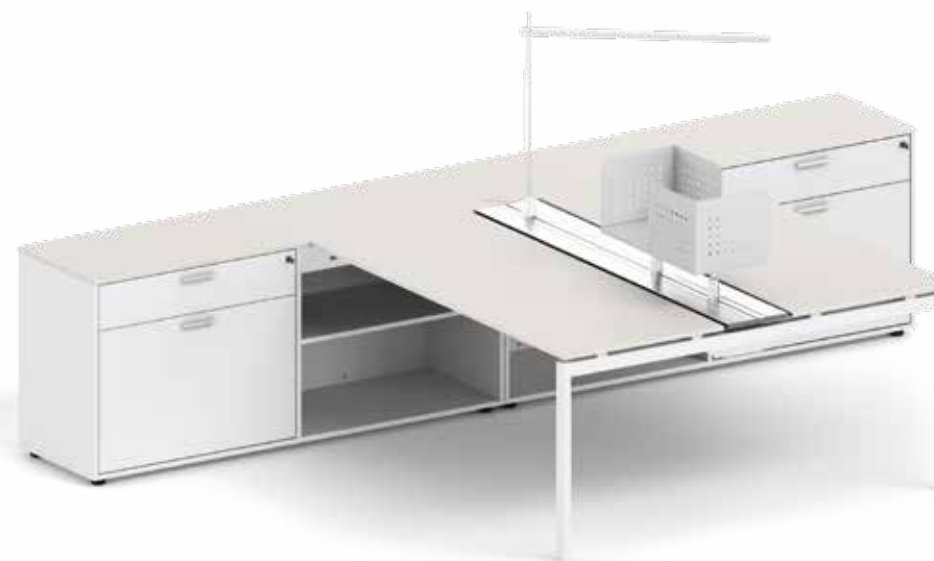

Esempi di composizioni con DV801 e DV802 /
Composition examples with DV801 and DV802

Comp. 7



Comp. 8



Contenitori / Storage units

Scocche e mensole sp. 1.8 cm, in melaminico / Bodies and shelves 1.8 cm thick, in melamine

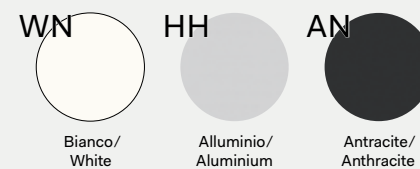

Ante e frontali cassetti sp. 1.8 cm, in melaminico con bordo ABS sp. 0.15 cm colore alluminio / Doors and drawers fronts 1.8 cm thick, in melamine with aluminium-coloured ABS edge-profiles 0.15 cm thick

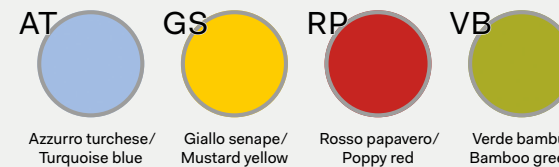

Ante e frontali cassetti sp. 1.8 cm, in melaminico con bordo ABS sp. 0.15 cm in tinta / Doors and drawers fronts 1.8 cm thick, in melamine with ABS edge-profiles 0.15 cm thick, in same color



Top Orgatower / Orgatower Top

Sp. 1.8 cm, in melaminico / 1.8 cm thick, in melamine



Maniglie / Handles

Q - V - T

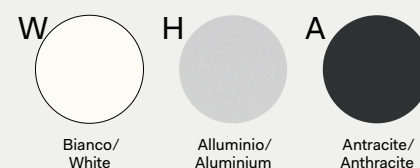

XBR



Interasse 96 mm / 96 mm Centers | Interasse 128 mm / 128 mm Centers | Interasse 256 mm / 256 mm Centers | Interasse 256 mm / 256 mm Centers | Interasse 96 mm / 96 mm Centers

Note

☒ Fino ad esaurimento. / Until exhaustion.

Moduli contenitori integrati L 166,5 P 48 x H 74/Integrated storage unit W 166,5 D 48 x H 74



505.CI.01.16.11_ 2 vani attrezzabili /2 equipppable compartments
 505.CI.02.16.11_ 1 vano attrezzabile e supporto scrivania/1 equipppable compartment and bracket for desk
 Sx/L - Dx/R
 505.CI.03.16.11_ 1 vano attrezzabile, canalizzazione e supporto scrivania/1 equipppable compartment, wire management and bracket for desk

Moduli contenitori integrati L 166,5 P 48 x H 115 / Integrated storage unit W 166,5 D 48 x H 115

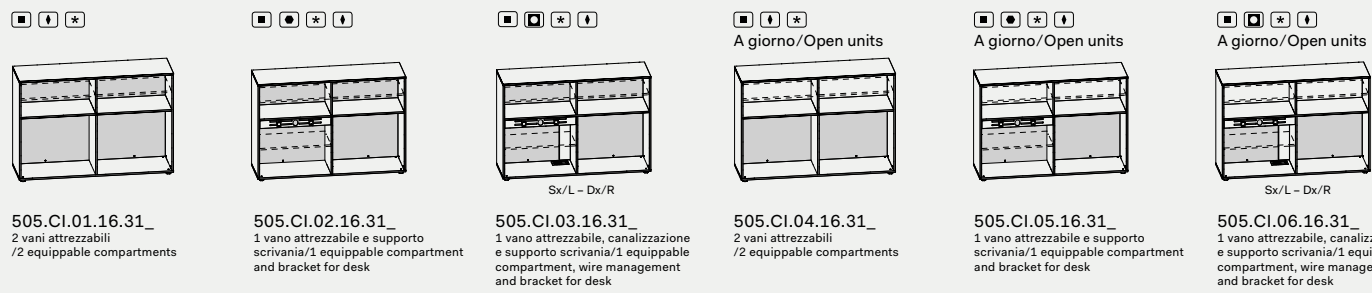

505.CI.01.16.31_ 2 vani attrezzabili /2 equipppable compartments
 505.CI.02.16.31_ 1 vano attrezzabile e supporto scrivania/1 equipppable compartment and bracket for desk
 Sx/L - Dx/R
 505.CI.03.16.31_ 1 vano attrezzabile, canalizzazione e supporto scrivania/1 equipppable compartment, wire management and bracket for desk
 A giorno/Open units
 505.CI.04.16.31_ 2 vani attrezzabili /2 equipppable compartments
 505.CI.05.16.31_ 1 vano attrezzabile e supporto scrivania/1 equipppable compartment and bracket for desk
 Sx/L - Dx/R
 505.CI.06.16.31_ 1 vano attrezzabile, canalizzazione e supporto scrivania/1 equipppable compartment, wire management and bracket for desk

Moduli contenitori integrati L 166,5 P 48 x H. 164,5/Integrated storage unit W 166,5 D 48 x H 164,5

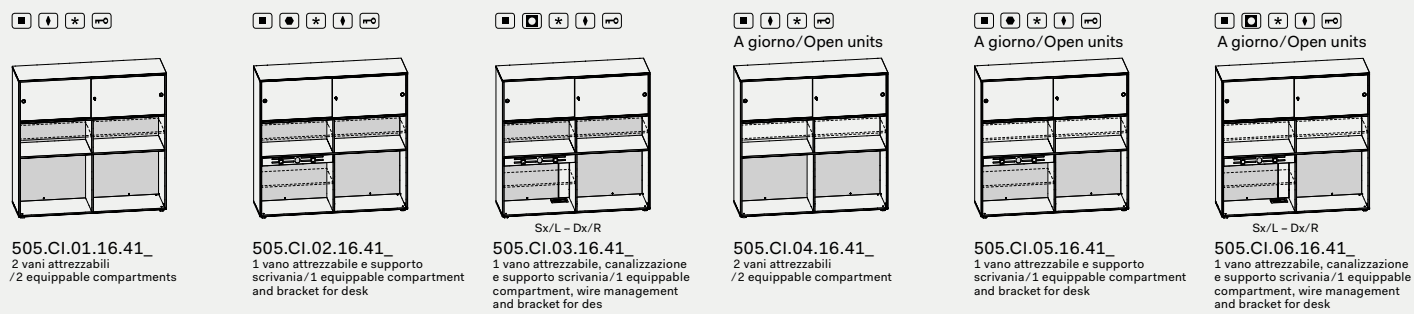

505.CI.01.16.41_ 2 vani attrezzabili /2 equipppable compartments
 505.CI.02.16.41_ 1 vano attrezzabile e supporto scrivania/1 equipppable compartment and bracket for desk
 Sx/L - Dx/R
 505.CI.03.16.41_ 1 vano attrezzabile, canalizzazione e supporto scrivania/1 equipppable compartment, wire management and bracket for desk
 A giorno/Open units
 505.CI.04.16.41_ 2 vani attrezzabili /2 equipppable compartment
 505.CI.05.16.41_ 1 vano attrezzabile e supporto scrivania/1 equipppable compartment and bracket for desk
 Sx/L - Dx/R
 505.CI.06.16.41_ 1 vano attrezzabile, canalizzazione e supporto scrivania/1 equipppable compartment, wire management and bracket for desk

Cassettiere per contenitori/Drawers for storage units

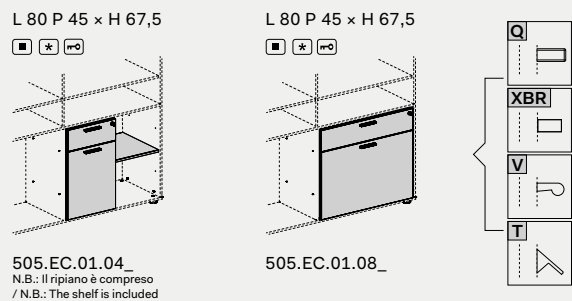

505.EC.01.04_ L 80 P 45 x H 67,5
 N.B.: Il ripiano è compreso / N.B.: The shelf is included
 505.EC.01.08_ L 80 P 45 x H 67,5

Supporto tavoli scrivania integrabili/Bracket for desk integration

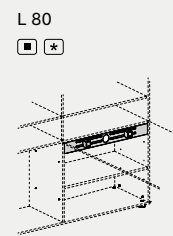

505.ES.01.08 L 80
 [Note:] È possibile integrare ai contenitori con supporto scrivania le serie DV801-DV802. Per l'integrazione con i tavoli DV812 vedi relativo catalogo./DV801-DV802 series can be integrated to the storage unit with desk support bracket. For the integration with DV812 tables see relative catalog.

Note:

- 1 Per la scelta degli accessori vari, consultare il relativo listino o catalogo./To choose accessories, please check correspondent price list or catalogue;
- 2 Le dimensioni sono espresse in cm - consultare il listino prezzi per le caratteristiche tecniche, i codici degli articoli e delle finiture./Dimensions are stated in cm - for technical characteristics, article code numbers and finishing see price list;
- 3 Per l'integrazione con i tavoli DV812 vedi relativo catalogo / For the integration with DV812 tables see relative catalog
- * Vano attrezzabile 1° livello/Equipppable compartment first level;
- Vano attrezzabile 1° livello con supporto per integrazione scrivania/Equipppable compartment first level with bracket for desk integration;
- ◻ Vano attrezzabile 1° livello con supporto per integrazione scrivania e canalizzazione/Equipppable compartment first level with bracket for desk integration and cable management;
- 1 Vano attrezzabile 2° livello/Equipppable compartment second level;
- ◻ Tutti gli articoli della serie DV505 - RIO non sono in pronta consegna. Per la disponibilità contattare l'ufficio commerciale./All the items of the DV505 - RIO series are not in prompt delivery. Please contact the commercial department to check availability.
- ☑ Con serratura/With lock.

Mensole/Shelf

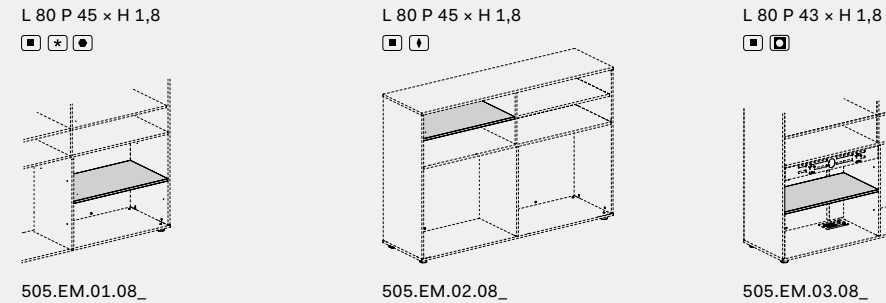

505.EM.01.08_ L 80 P 45 x H 1,8
 505.EM.02.08_ L 80 P 45 x H 1,8
 505.EM.03.08_ L 80 P 43 x H 1,8

Orgatower P 65/Orgatower P 65

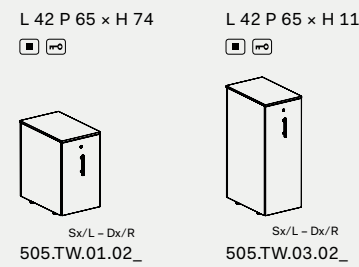

L 42 P 65 x H 74
 505.TW.01.02_ Sx/L - Dx/R
 L 42 P 65 x H 115
 505.TW.03.02_ Sx/L - Dx/R

Supporti per tavoli su Orgatower P 65/Brackets for desks on Orgatower P 65

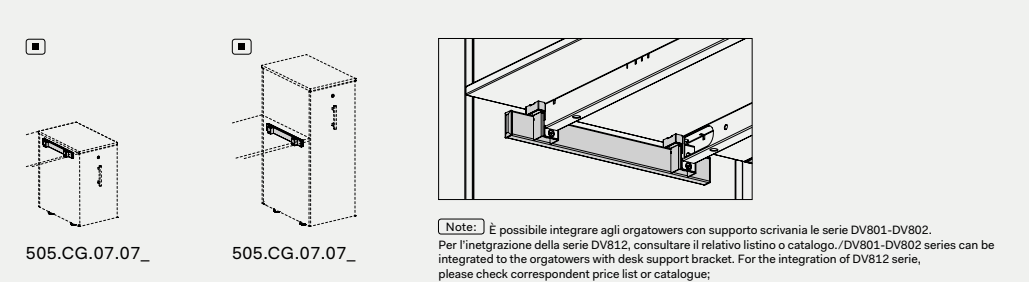

[Note:] È possibile integrare agli orgatowers con supporto scrivania le serie DV801-DV802. Per l'integrazione della serie DV812, consultare il relativo listino o catalogo./DV801-DV802 series can be integrated to the orgatowers with desk support bracket. For the integration of DV812 series, please check correspondent price list or catalogue;

Orgatower P 80/Orgatower P 80

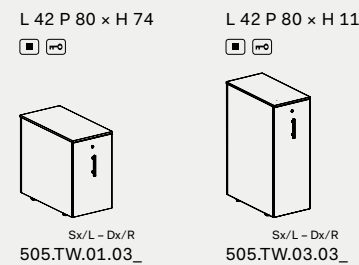

L 42 P 80 x H 74
 505.TW.01.03_ Sx/L - Dx/R
 L 42 P 80 x H 115
 505.TW.03.03_ Sx/L - Dx/R

Supporti per tavoli su Orgatower P 80/Brackets for desks on Orgatower P 80



[Note:] È possibile integrare agli orgatowers con supporto scrivania le serie DV801-DV802. Per l'integrazione della serie DV812, consultare il relativo listino o catalogo./DV801-DV802 series can be integrated to the orgatowers with desk support bracket. For the integration of DV812 series, please check correspondent price list or catalogue;

Note:

- 1 Per la scelta degli accessori vari, consultare il relativo listino o catalogo./To choose accessories, please check correspondent price list or catalogue;
- 2 Le dimensioni sono espresse in cm - consultare il listino prezzi per le caratteristiche tecniche, i codici degli articoli e delle finiture./Dimensions are stated in cm - for technical characteristics, article code numbers and finishing see price list;
- 3 Per l'integrazione con i tavoli DV812 vedi relativo catalogo / For the integration with DV812 tables see relative catalog
- ◻ Tutti gli articoli della serie DV505 - RIO non sono in pronta consegna. Per la disponibilità contattare l'ufficio commerciale./All the items of the DV505 - RIO series are not in prompt delivery. Please contact the commercial department to check availability.
- ☑ Con serratura/With lock.

DV522 Roma

Design:
Antonio Morello

IT Le librerie ad “ante scorrevoli” sono caratterizzate dalle molteplici combinazioni cromatiche e formali che si possono configurare grazie alla varietà di ante in melaminico o in vetro. Il meccanismo che permette alle ante di scorrere è predisposto per agganciare con facilità le stesse che sono anche provviste di particolare “soft-closing” nella fase di fine corsa.

EN The bookshelves with “sliding doors” are characterised by their chromatic and formal combination possibilities, supported by the variety of melamine and glass doors. The sliding rail mechanism is conceived to allow an easy installation of the doors and is also equipped with a special soft close device.







**Librerie ante scorrevoli /
Bookshelves with sliding doors**

Altezza	Height	Larghezza	Width	Profondità	Depth
A - 90 cm	H - 35 1/2"	L - 180 cm	W - 70 3/4"	P - 36.3 cm	D - 14 1/4"
A - 170 cm	H - 67"				

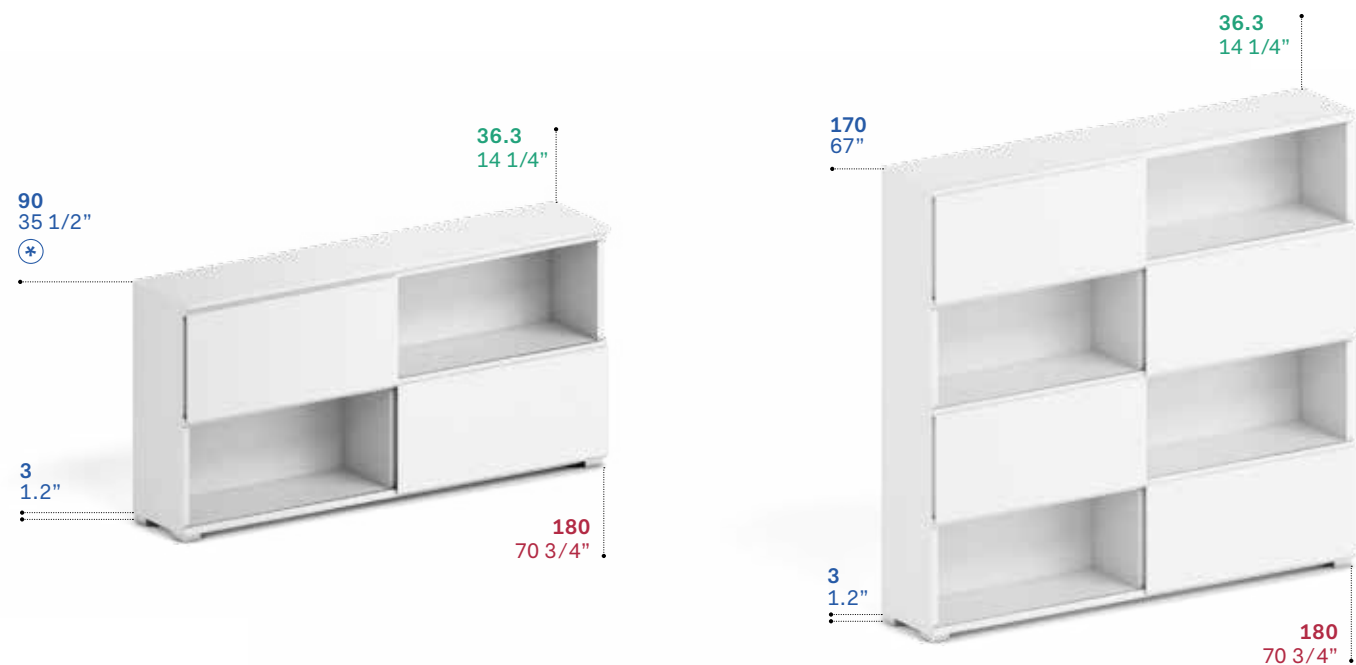

* Altezza con top Optional /
Height with top Optional

**Tipologie librerie ante scorrevoli H: 88.2 cm /
Bookshelves types with sliding doors H: 34 3/4"**



* Con Top (Optional) in abbinamento, sp. 1.8 cm /
With matching (Optional) Top, 3/4" thick

**Tipologie di ante /
Door types**

Ante in cuoio (■), sp. 1.2 cm /
Leather doors (■), 1/2" thick



Ante in vetro retrolaccato, sp. 0.5 cm /
Rear-lacquered glass doors, 1/4" thick



Ante in Melaminico - Impiallacciato (■), sp. 1 cm /
Melamine - Veneered (■) doors, 1/2" thick



■ Solo su richiesta /
With matching (Optional)

Tipologie librerie ante scorrevoli H: 170 cm /
Bookshelves types with sliding doors H: 67"



★ Con Top (Optional) in abbinamento, sp. 1.8 cm /
With matching (Optional) Top, 3/4" thick

Tipologie di ante /
Door types

Ante in cuoio (●), sp. 1.2 cm /
Leather doors (●), 1/2" thick

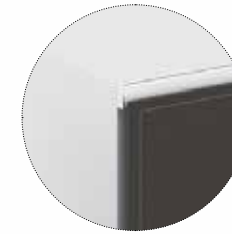

Ante in vetro retrolaccato, sp. 0.5 cm /
Rear-lacquered glass doors, 1/4" thick



Ante in Melaminico - Impiallacciato (●), sp. 1 cm /
Melamine - Veneered (●) doors, 1/2" thick



● Solo su richiesta /
With matching (Optional)

Contenitori/Storage units

Scocca e ripiani sp. 3 cm, in melaminico/Body and shelves 3 cm thick, in melamine



Ante scorrevoli sp. 1 cm e Top (Optional) sp. 1.8 cm, in melaminico/Sliding doors 1 cm thick and Top (Optional) 1.8 cm thick, in melamine

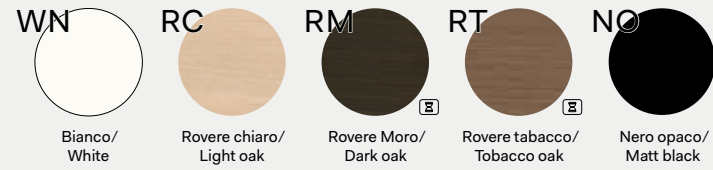

Ante scorrevoli sp. 0.5 cm, in vetro temprato/Sliding doors 0.5 cm thick, tempered glass



Ante scorrevoli sp. 1 cm e Top (Optional) sp. 1.8 cm, in impiallacciato/Sliding doors 1 cm thick and Top (Optional) 1.8 cm thick, veneered

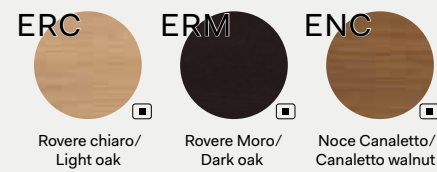

Ante scorrevoli sp. 1.2 cm, in cuoio con cuciture/Sliding doors 1.2 cm thick, in leather with stitches



Note

■ Prodotti non in pronta consegna. Per la disponibilità contattare l'ufficio commerciale/Items not in prompt delivery. Please contact the commercial department to check availability.

Ⓜ Fino ad esaurimento. / Until exhaustion.

Librerie ante scorrevoli/Bookshelves with sliding doors

L 180 P 34,5 x H 170

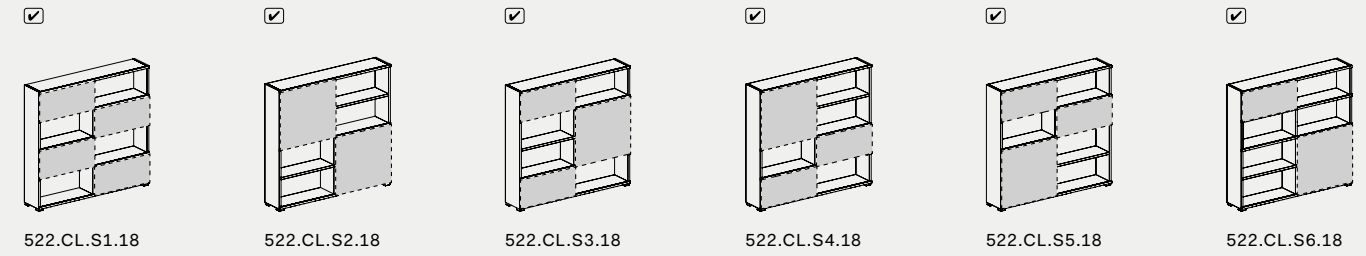

L 180 P 34,5 x H 170

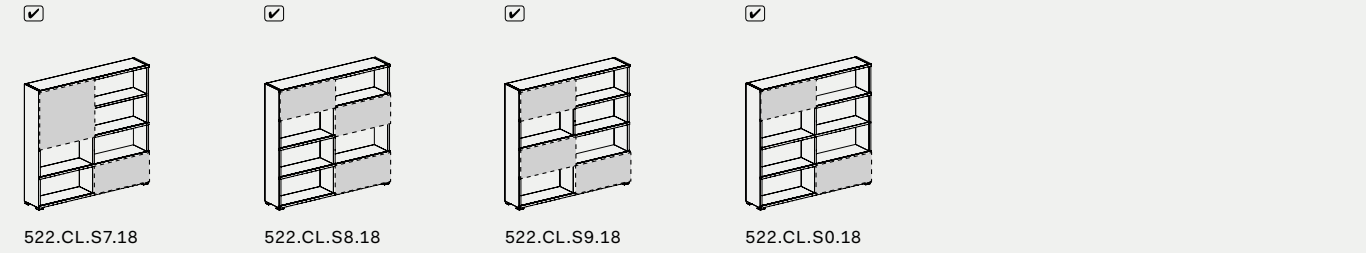

L 180 P 34,5 x H 88,2

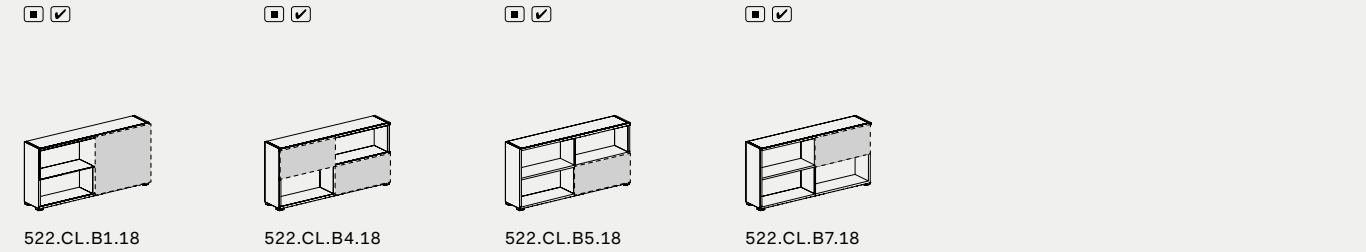

Ante scorrevoli in melaminico - impiallacciato /Melamine - veneered sliding doors

L 90 P 1 x H 40,5

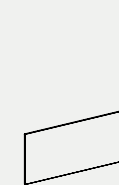

522.CL.A4.09_

L 90 P 1 x H 81,5



522.CL.A8.09_

Ante scorrevoli in vetro /Glass sliding doors

L 90 P 0,5 x H 40,5



522.CL.V4.09

L 90 P 0,5 x H 81,5



522.CL.V8.09

Ante scorrevoli in cuoio /Leather sliding doors

L 90 P 1,2 x H 40,5



522.CL.P4.09_

L 90 P 1,2 x H 81,5

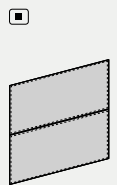

522.CL.P8.09_

Top (Optional)

L 180 P 36,3 x H 1,8

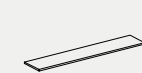

522.CU.TA.18_

Note:

Ⓜ Le finiture impiallacciato e cuoio non sono in pronta consegna. Per la disponibilità contattare l'ufficio commerciale/Veneered and leather finishes are not in prompt delivery. Please contact the commercial department to check availability;

② Le dimensioni sono espresse in cm - consultare il listino prezzi per le caratteristiche tecniche, i codici degli articoli e delle finiture/Dimensions are stated in cm - for technical characteristics, article code numbers and finishing see price list;

✓ Le ante rappresentate nelle librerie non sono comprese nei codici di vendita e quindi sono da ordinare a parte, scegliendole tra quelle in melaminico, vetro o cuoio (H 40,5 o H 81,5) come indicato nella composizione da realizzare/The doors shown on the bookshelves are not included in our sales code numbers, therefore they need to be ordered separately, choosing from the melamine, glass or leather finishes (H 40,5 or H 81,5) as indicated in the composition to be created;

■ Prodotti non in pronta consegna. Per la disponibilità contattare l'ufficio commerciale/Items not in prompt delivery. Please contact the commercial department to check availability.

DV525 Riga

Design:
Antonio Morello

IT Libreria componibile realizzata in melaminico, grosso spessore, può essere posizionata a parete o in centro stanza. Possibilità di molteplici abbinamenti cromatici fra scocche, ante e schiene nelle diverse finiture disponibili.

EN Modular library made in melamine, important thickness, which can be placed against the wall or in the middle of the room. Possibility of multiple color combinations between body, doors and back panels in the different finishes available.







**Libreria componibile /
Modular bookshelf**

Altezza	Height	Larghezza	Width	Profondità	Depth
A - 129 cm	H - 50 3/4"	L - 45.4 cm	W - 17 7/8"	P - 41.2 cm	D - 16 1/4"
A - 171 cm	H - 67 1/4"	L - 86.6 cm	W - 34"		
A - 212 cm	H - 83 1/2"				
A - 254 cm	H - 100"				

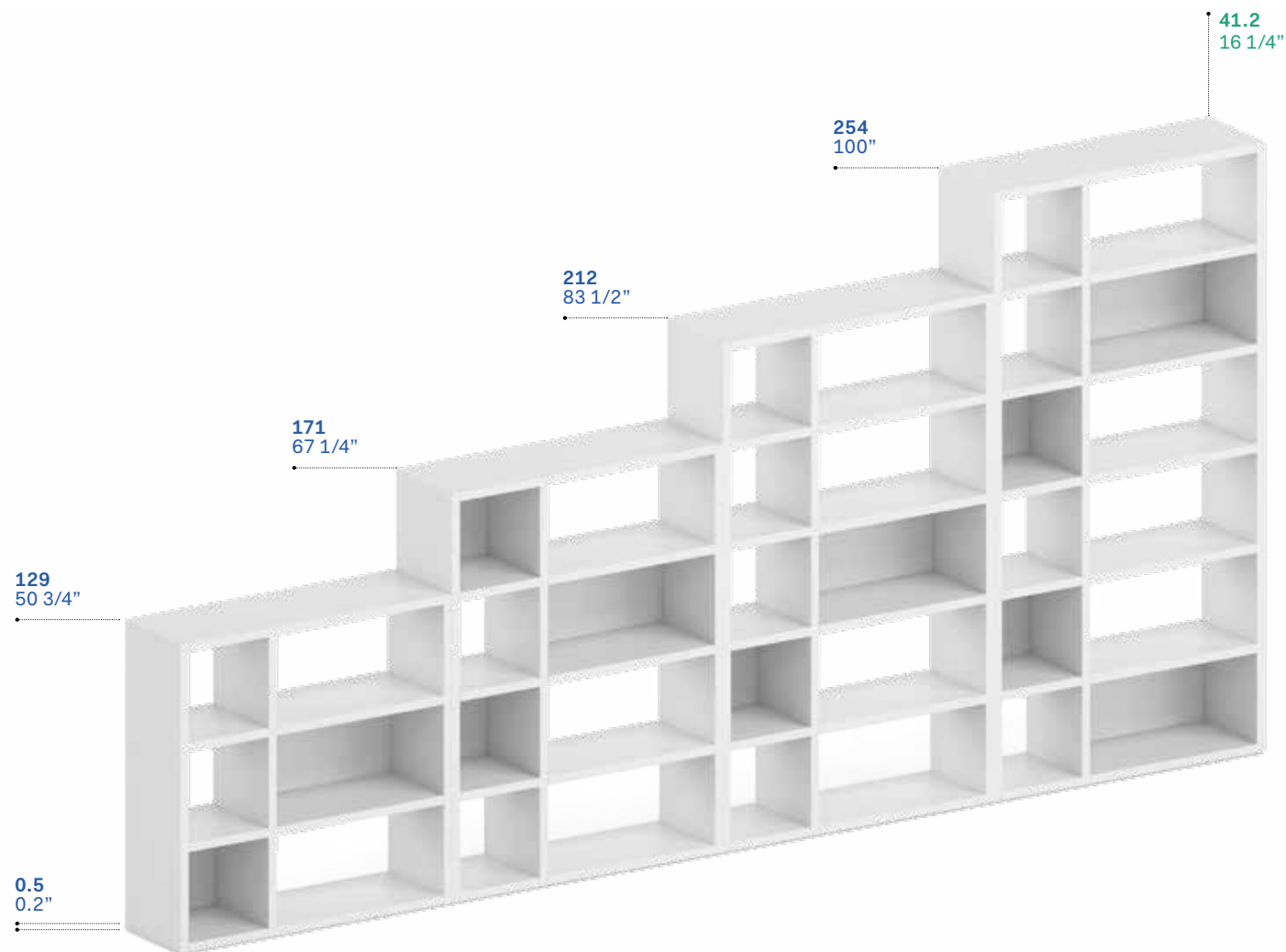

Larghezza moduli 45.4 - 86.6 cm /
Width modules 17 7/8" - 34"

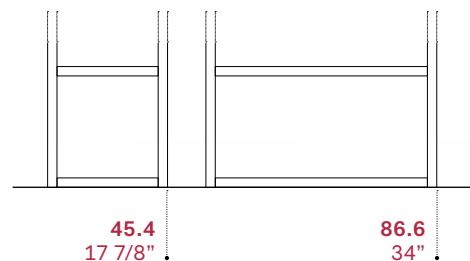

Esempi di composizioni / Composition examples

**Schiena esterna di finitura * /
External finishing back panel ***

Altezza	Height	Larghezza	Width	Profondità	Depth
A - 41 cm	H - 16 1/4"	L - 41 cm	W - 16 1/4"	P - 1.8 cm	D - 3/4"
A - 41 cm	H - 16 1/4"	L - 82.2 cm	W - 32 2/4"	P - 1.8 cm	D - 3/4"

**Schiena interna ** /
Internal back panel ****

Altezza	Height	Larghezza	Width	Profondità	Depth
A - 37.7 cm	H - 14 3/4"	L - 37.7 cm	W - 14 3/4"	P - 1.8 cm	D - 3/4"
A - 37.7 cm	H - 14 3/4"	L - 78.9 cm	W - 31"	P - 1.8 cm	D - 3/4"

Comp. 1

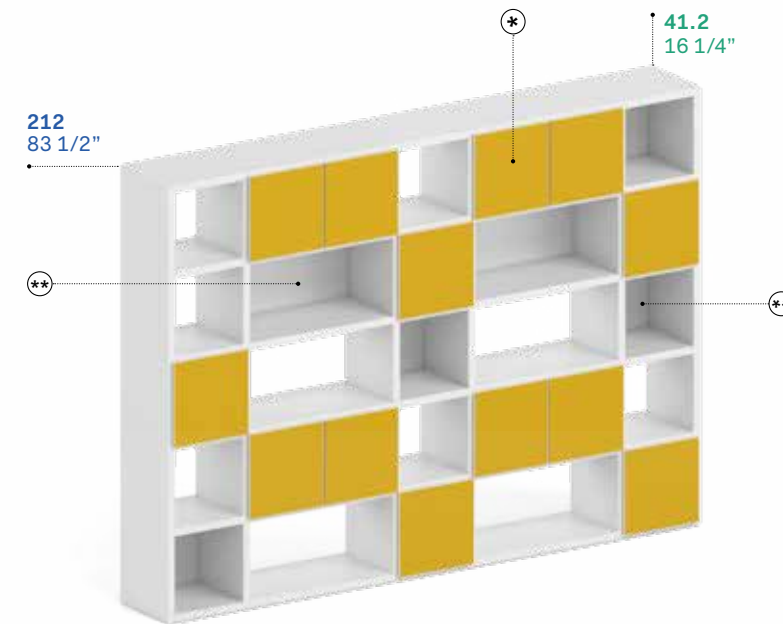

Comp. 2

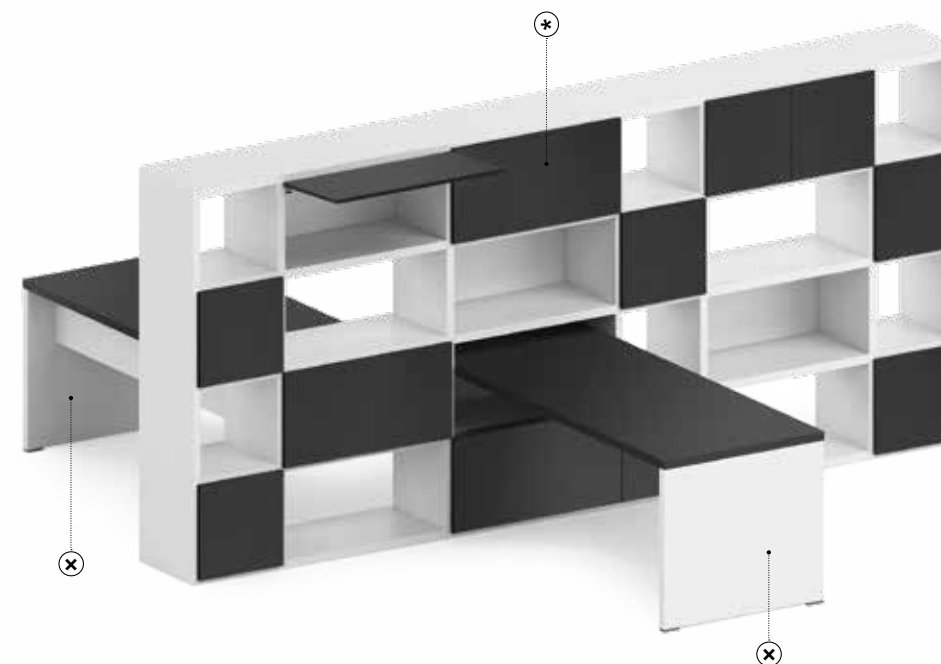

**Tavoli scrivania integrabili alla libreria componibile x /
Desk for integration to the modular library x**

Altezza	Height	Larghezza	Width	Profondità	Depth
A - 74 cm	H - 29 1/4"	L - 199 cm	W - 78 1/2"	P - 78.8 cm	D - 31"

Note: Posizionamento a filo anteriore L: 160 cm. Posizionamento a filo posteriore L: 192.5 cm. Posizionamento centrale e posizionamento con due scrivanie contrapposte L: 178.4 cm. / Internal positioning W: 63". External positioning W: 75 3/4". Central positioning and positioning with two desks W: 70 1/4".

Contenitori/Storage units

Struttura portante sp. 3.8 cm, in melaminico con bordi perimetrali in ABS nei lati in vista sp. 0.15 cm / Carrying structure 3.8 cm thick, in melamine with 0.15 cm ABS profiles on visible edges



Piani di lavoro e gambe pannellate sp.3.8 cm, schiena sp. 1.8 cm in melaminico con bordi in ABS sp. 0.15 cm / Worktops and paneled legs in 3.8 cm thickness, back panel in 1.8 cm thick melamine with 0.15 cm thick ABS edge-profiles



Schienze e ante sp. 1.8 cm, in impiallacciato in tinta con bordi perimetrali in ABS in tinta / Back panels and doors 1.8 cm thick, veneered with ABS edge-profiles, in same color

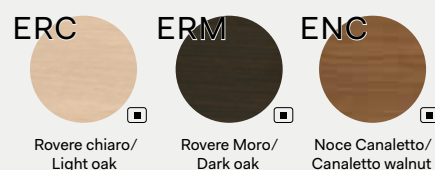

Schienze e ante sp.1.8 cm, in laminato con bordi perimetrali in ABS sp. 0.15 cm in tinta / Back panels and doors 1.8 cm thick, in laminate with 0.15 cm ABS edge-profiles, in same color



Schienze e ante sp.1.8 cm, in melaminico con bordi perimetrali in ABS sp. 0.15 cm colore bianco / Back panels and doors 1.8 cm thick, in melamine with white-coloured 0.15 cm ABS edge-profiles

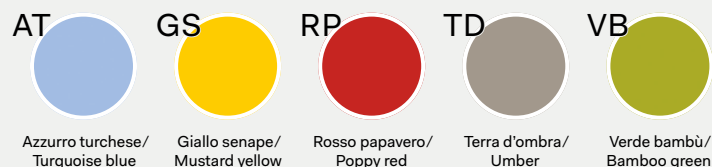

Schienze e ante sp.1.8 cm, in melaminico con bordi perimetrali in ABS sp. 0.15 cm in tinta / Back panels and doors 1.8 cm thick, in melamine with 0.15 cm ABS edge-profiles, in same color



Note:
 [] Prodotti non in pronta consegna. Per la disponibilità contattare l'ufficio commerciale / Items not in prompt delivery. Please contact the commercial department to check availability.
 [] Fino ad esaurimento. / Until exhaustion.

Scocca / Body

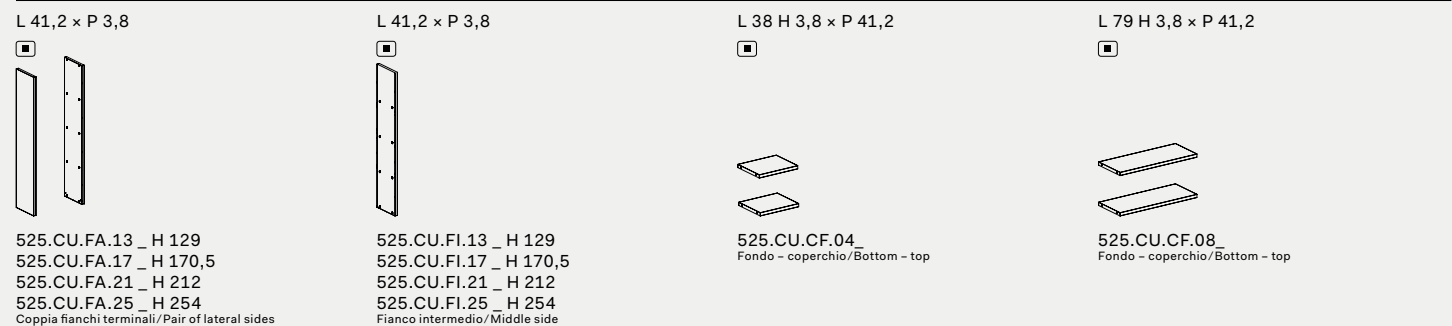

Note: N.B.: sulla scocca non sono presenti fori o pre-fori. Per il montaggio di ante, push-pull e schiene è necessario acquistare la dima. / N.B.: Drills or pre-drills are not present on the body. For assembly of doors, push-pull and back panels, it is necessary to order the drilling tool.

Ripiani L 38 / Shelves W 38



Ripiani L 79 / Shelves W 79



Tavoli scrivania integrabili / Connectible desks



Dima / Drilling template



Canalizzazione / Wire management

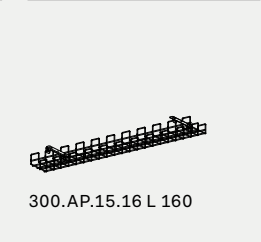

Ante / Doors

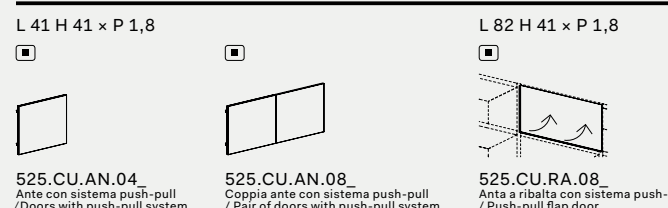

Schienze interne / Inner back panel

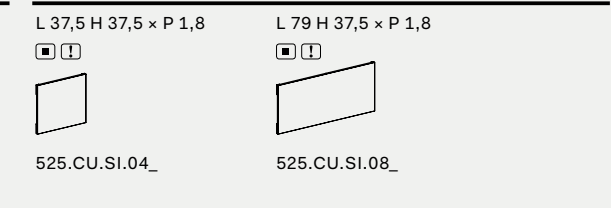

Schienze esterne / Outer back panel

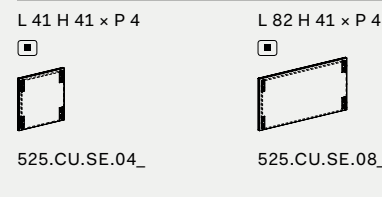

Esempio di composizione H 212 / Composition example H212

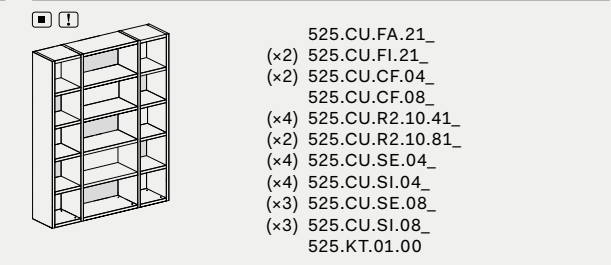

Note: È obbligatorio integrare alle librerie componibili almeno 1 schiena (interna o interna + esterna di finitura) per ogni due colonne / It is obligatory to integrate at least 1 back panel (internal or internal + external finishing panel) each two columns

Note:
 [] Le dimensioni sono espresse in cm - consultare il listino prezzi per le caratteristiche tecniche, i codici degli articoli e delle finiture / Dimensions are stated in cm - for technical characteristics, article code numbers and finishing see price list;
 [] Le librerie con solo schienali interni vanno sempre fissate a muro. E' obbligatorio fissare a muro le librerie con altezza superiore a 175 cm - 69" per evitare il ribaltamento. Il sistema di ancoraggio a pavimento o a soffitto per le librerie posizionate a centro stanza non è previsto a listino, è quindi a carico del cliente;
 [] Tutti gli articoli della serie DV525 - RIGA non sono in pronta consegna. Per la disponibilità contattare l'ufficio commerciale / All the items of the DV525 - RIGA series are not in prompt delivery. Please contact the commercial department to check availability.
 [] Ante e schienali in questi colori sono bordate in ABS perimetrale, colore bianco / Doors and back panels in above colours are manufactured with a white ABS edge-profile;
 [] Bookshelves with only internal back panels need to be fixed to the wall. It is obligatory to fix against the wall the libraries higher than 175 cm - 69", in order to prevent tipping. The fixing mechanism to the floor or ceiling for libraries positioned in the middle of the room, is not provided in the Price List, it is at client's expense.

DV527 Taba

Design:
Antonio Morello

IT Libreria metallica a moduli disponibili in diverse altezze nei colori antracite e bianco. Realizzata con tubolari in alluminio a sezione quadrata e collegati mediante giunti in zama. Leggera e minimale, permette di realizzare soluzioni contemporanee e di tendenza assicurando la massima funzionalità.

EN Metal bookcase with modules, available in different heights, in anthracite or white color. Made of squared aluminum tubes, connected by zamak joints. Light and minimal design, allows to create a contemporary and trendy solution ensuring maximum functionality.







**Moduli singoli /
Single modules**

Altezza A - 40 cm	Height H - 15 3/4"	Larghezza L - 40 cm	Width W - 15 3/4"	Profondità P - 40 cm	Depth D - 15 3/4"
A - 78 cm	H - 30 3/4"	L - 80 cm	W - 31 1/2"		
A - 116 cm	H - 45 3/4"				
A - 154 cm	H - 60 3/4"				
A - 192 cm	H - 75 1/2"				

**Esempi di composizione/
Composition Examples**

- 1** Modulo terminale aperto
L: 78 cm - H: 154 cm /
Terminal open module
W: 33 3/4" - H: 60 3/4"
- 2** Modulo intermedio
L: 38 cm - H: 154 cm /
Middle module
W: 15" - H: 60 3/4"
- 3** Modulo intermedio
L: 78 cm - H: 154 cm /
Middle module
W: 30 3/4" - H: 60 3/4"
- 4** Modulo terminale
L: 80 cm - H: 154 cm /
Terminal module
W: 31 1/2" - H: 60 3/4"

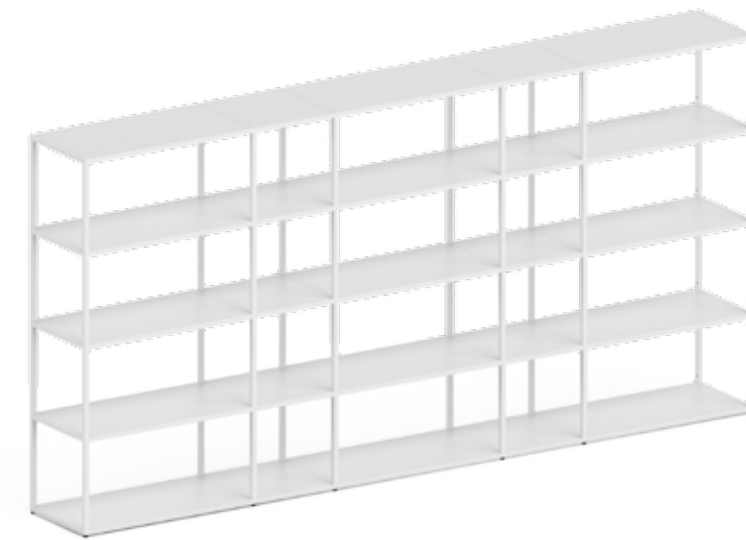
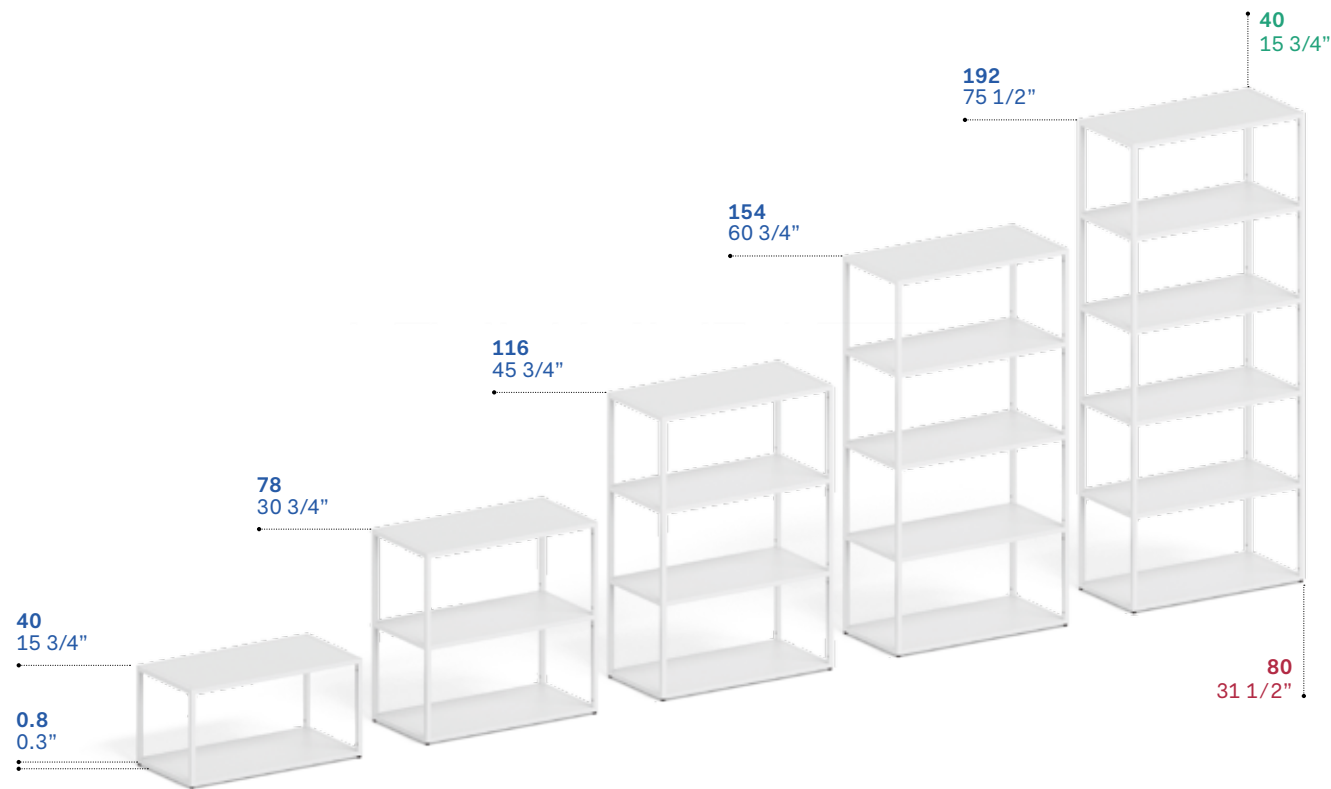
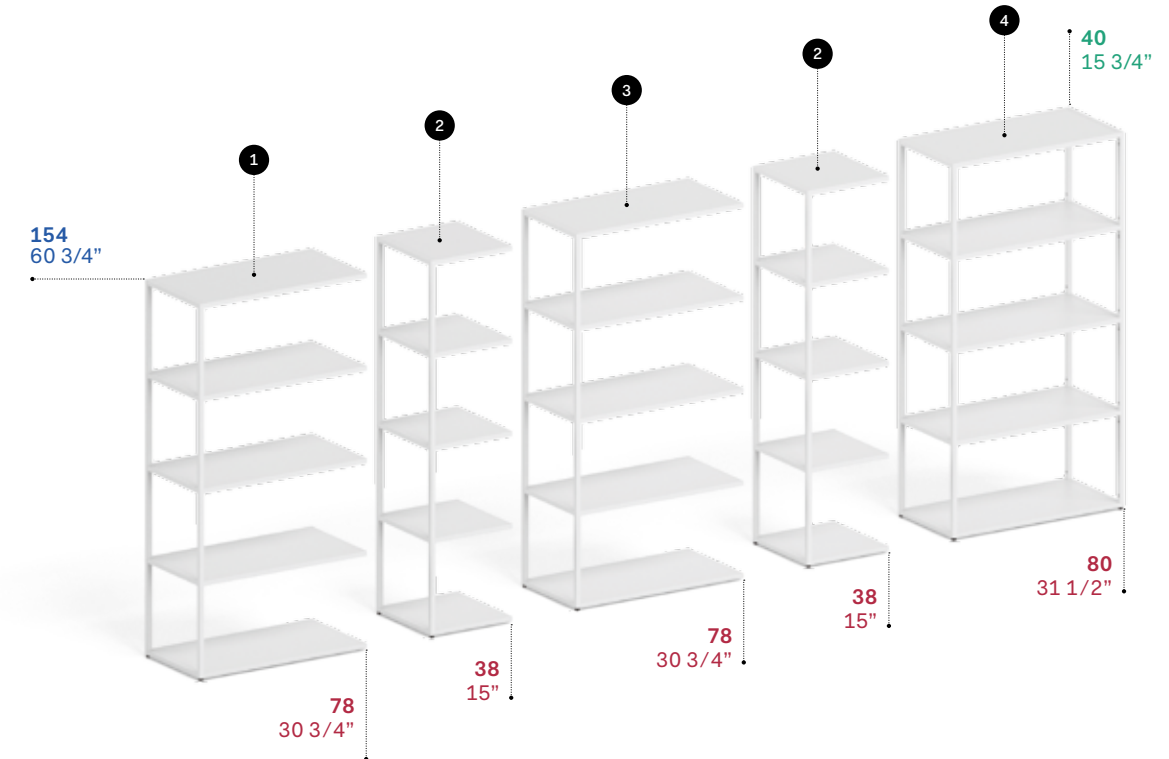
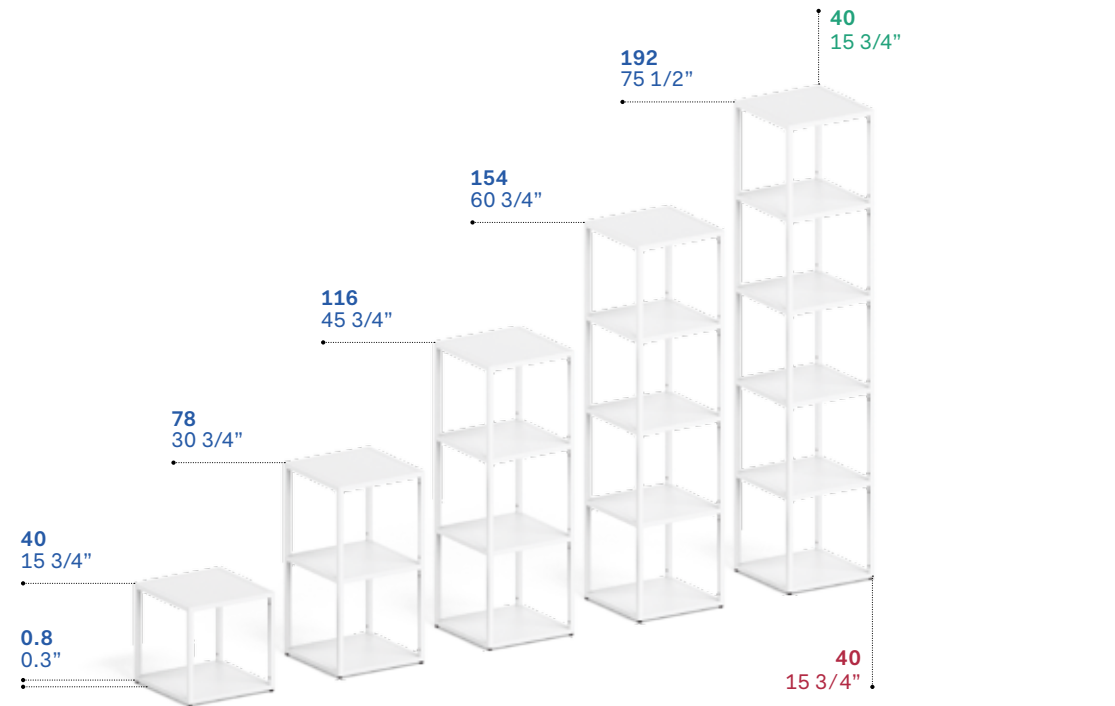

[Note:] Per le composizioni con moduli di altezze diverse è necessario "chiudere" la composizione utilizzando il modulo singolo, il modulo terminale o il modulo terminale aperto /
For compositions with modules of different heights it is necessary to "close" the composition using the single module, the terminal module or the open terminal module.

Vaschette - Fioriere /
Tray - Planter

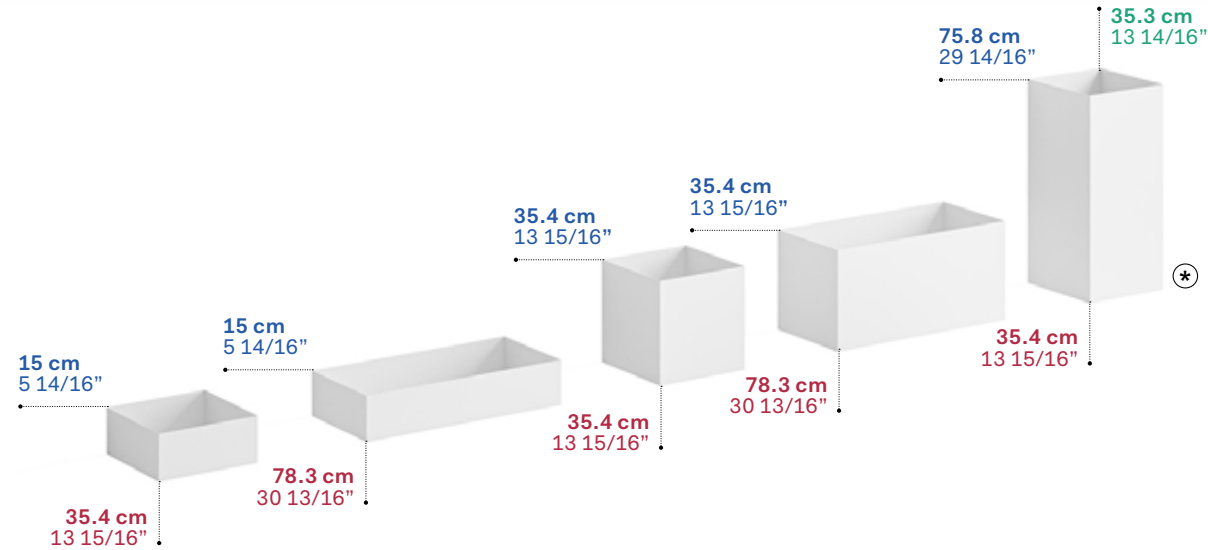

Esempi di composizione /
Composition Examples



* Questa vaschetta può essere utilizzata solamente con i moduli H. 78 cm /
This tray can only be used with modules H. 30 3/4"

Libreria componibile/Modular bookshelf

Struttura in metallo verniciato con tubolari sezione quadrata, 2x2 cm /
Painted metal structure composed of 2x2 cm thick square tubes

Vaschette - Fioriere/Tray - Planter

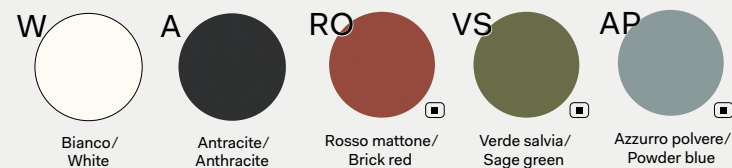
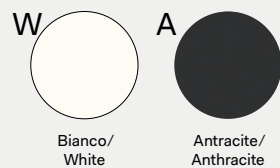

Note

Prodotti non in pronta consegna. Per la disponibilità contattare l'ufficio commerciale. / Items not in prompt delivery. Please contact the commercial department to check availability.

Moduli singoli/Single modules

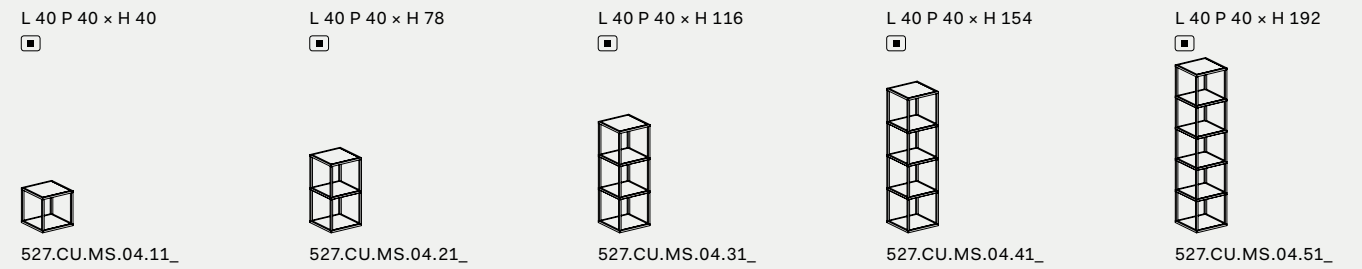

Moduli terminali/ Terminal modules ^A

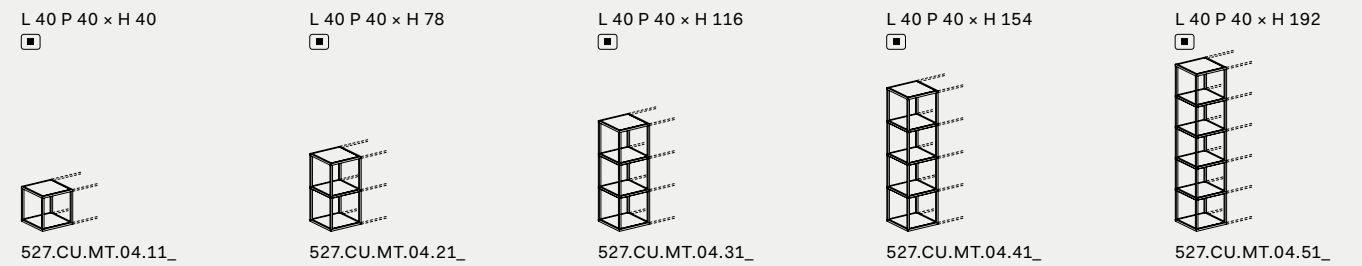

Moduli Intermedi/ Middle modules ^B

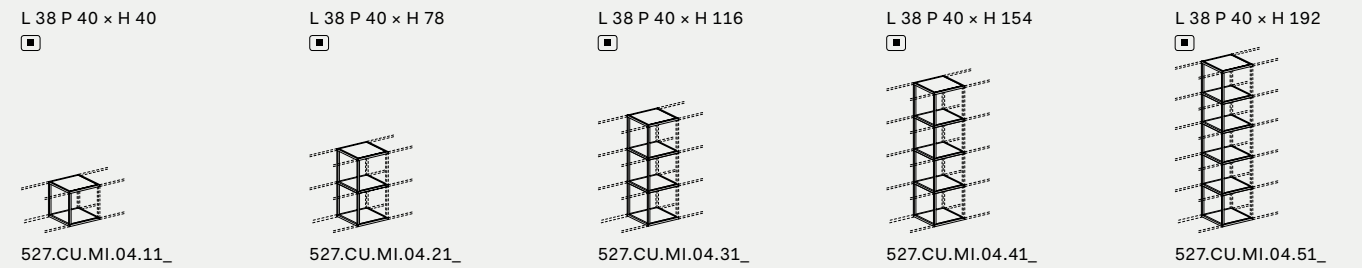

Moduli terminali aperti/ Open terminal modules ^C

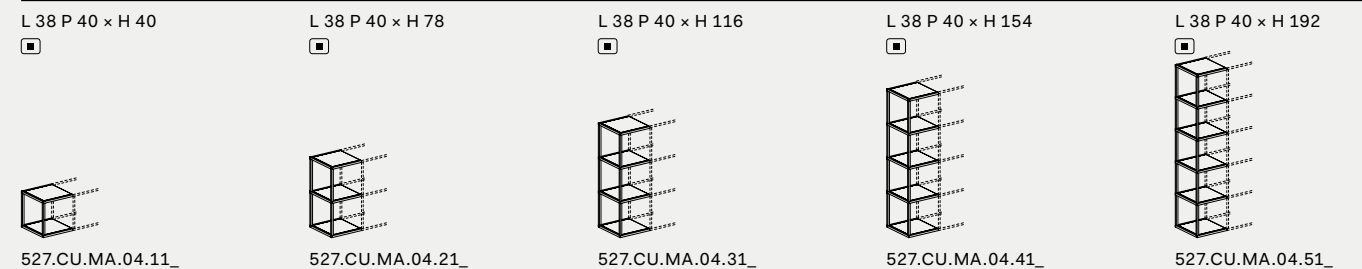

Moduli singoli/Single modules



Note:

Le dimensioni sono espresse in cm - consultare il listino prezzi per le caratteristiche tecniche, i codici degli articoli e delle finiture/ Dimensions are stated in cm - for technical characteristics, article code numbers and finishing see price list;

Tutti gli articoli della serie DV527 - TABA non sono in pronta consegna. Per la disponibilità contattare l'ufficio commerciale. / All the items of the DV527 - TABA series are not in prompt delivery. Please contact the commercial department to check availability.

Moduli terminali/ Terminal modules **A**

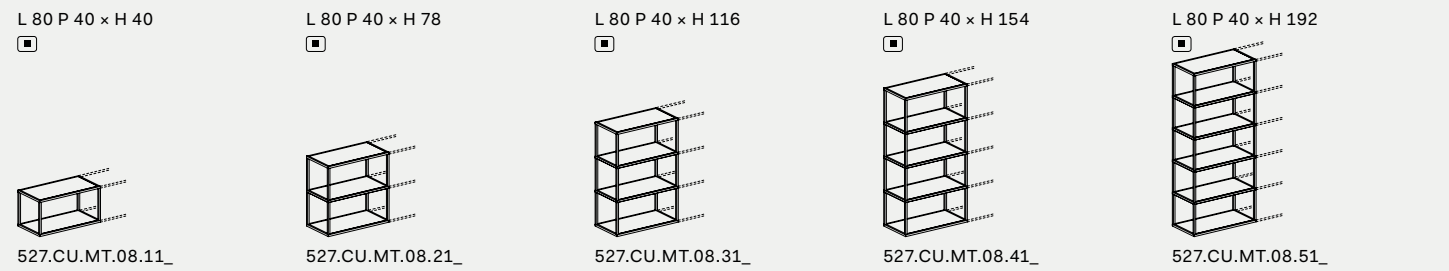

Moduli Intermedi/ Middle modules **B**

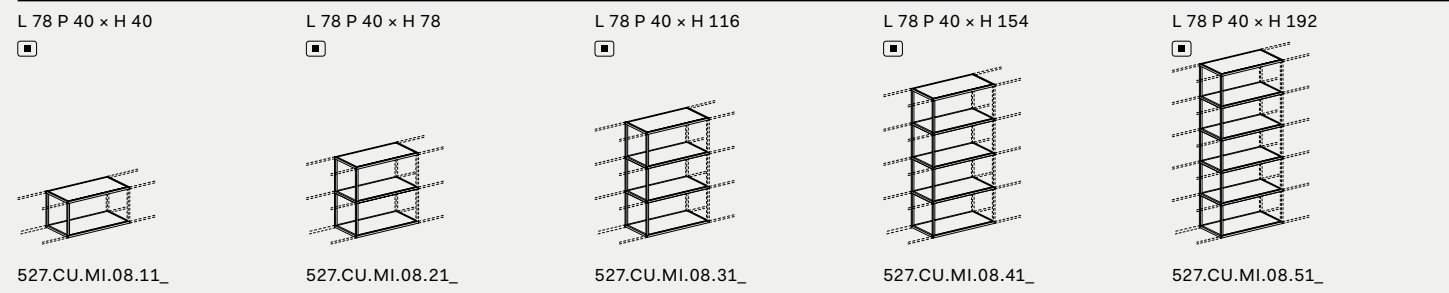

Moduli terminali aperti/ Open terminal modules **C**

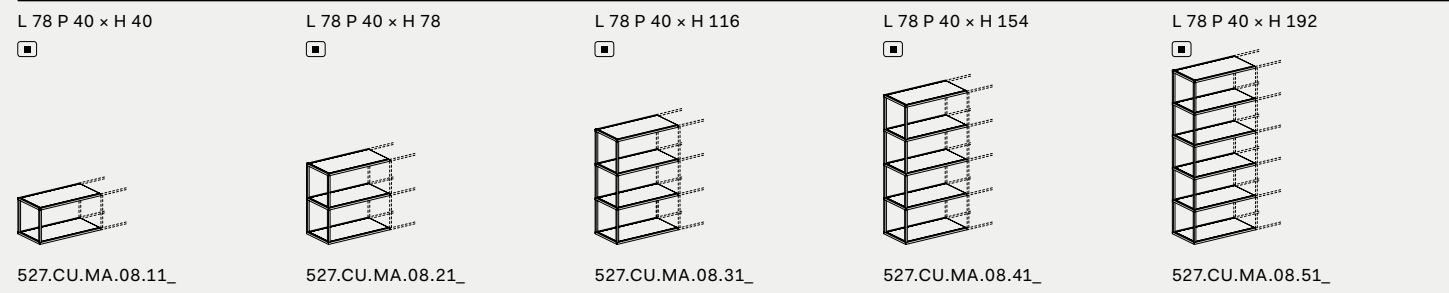

Kit di fissaggio a muro / Kit for wall fixing

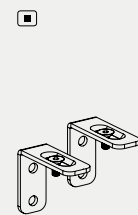

527.KT.01.00_

Esempio di composizione/ Composition example

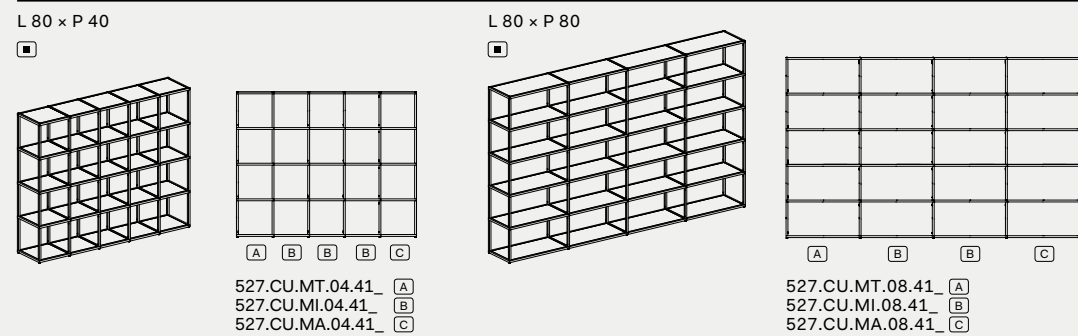

Nelle composizioni con moduli con la stessa altezza, esternamente utilizzare 1 modulo terminale **A** ed 1 modulo terminale aperto **C**
/In the compositions with modules with the same height, externally use 1 terminal module **A** and 1 open terminal module **C**

Note:

1 Le dimensioni sono espresse in cm - consultare il listino prezzi per le caratteristiche tecniche, i codici degli articoli e delle finiture/Dimensions are stated in cm - for technical characteristics, article code numbers and finishing see price list;

2 Tutti gli articoli della serie DV527 - TABA non sono in pronta consegna. Per la disponibilità contattare l'ufficio commerciale /All the items of the DV527 - TABA series are not in prompt delivery. Please contact the commercial department to check availability.

Vaschette - fioriere/ Tray - planter

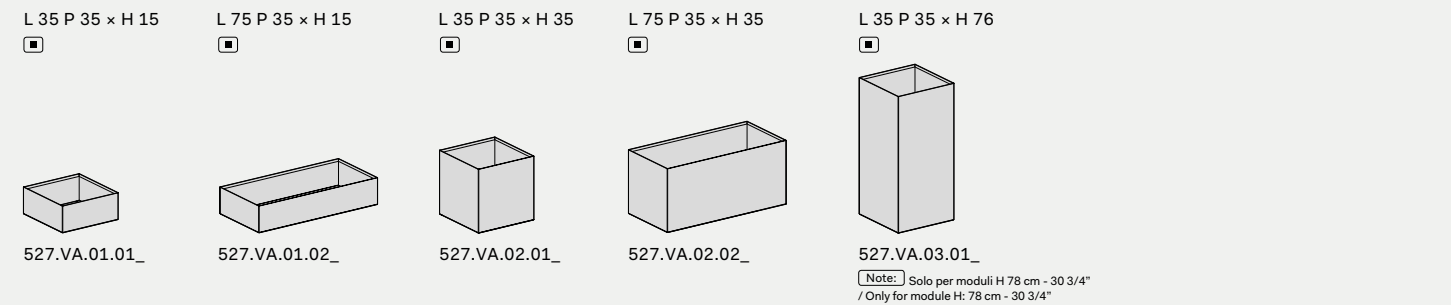

Esempio di composizione/ Composition example

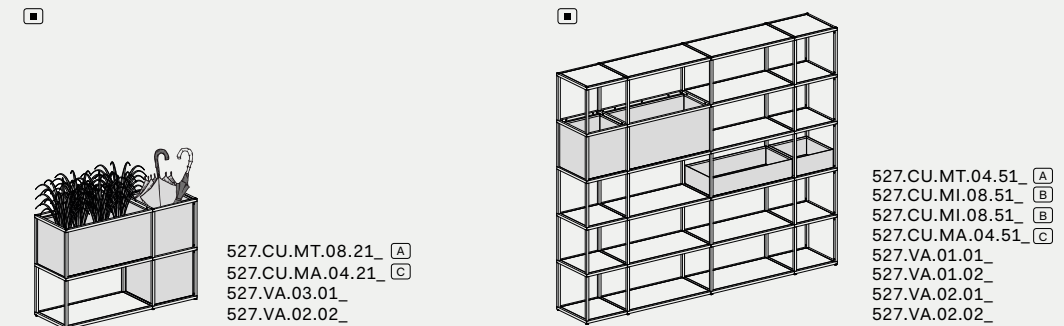

Note:

1 Le dimensioni sono espresse in cm - consultare il listino prezzi per le caratteristiche tecniche, i codici degli articoli e delle finiture/Dimensions are stated in cm - for technical characteristics, article code numbers and finishing see price list;

2 Tutti gli articoli della serie DV527 - TABA non sono in pronta consegna. Per la disponibilità contattare l'ufficio commerciale /All the items of the DV527 - TABA series are not in prompt delivery. Please contact the commercial department to check availability.

DV530 Boiserie

Design:
Antonio Morello

IT Eleganti e di forte impatto estetico, le “boiserie” permettono di completare con stile qualsiasi ambiente di lavoro. Disponibili in due altezze nelle diverse finiture, si abbinano alle varie serie di scrivanie proposte a catalogo e possono essere accostate tra di loro o sovrapposte sui contenitori universali. Le mensole sono disponibili in vetro acidato.

EN The “boiserie” elegant and aesthetically strong, furnish with style any working environment. Available in two heights and several finishes, they match various desks proposed in our catalogues. They can be positioned side by side or on top of universal storage units. The shelves are in acetated glass.







Boiserie

Altezza	Height
A - 123 cm	H - 48 1/2"
A - 207.5 cm	H - 81 3/4"



Larghezza	Width
L - 180 cm	W - 70 3/4"



Profondità	Depth
P - 3.5 cm	D - 1 1/4"
P - 24.5 cm	D - 9 3/4"



Sp. 0.8
1/4" Thick

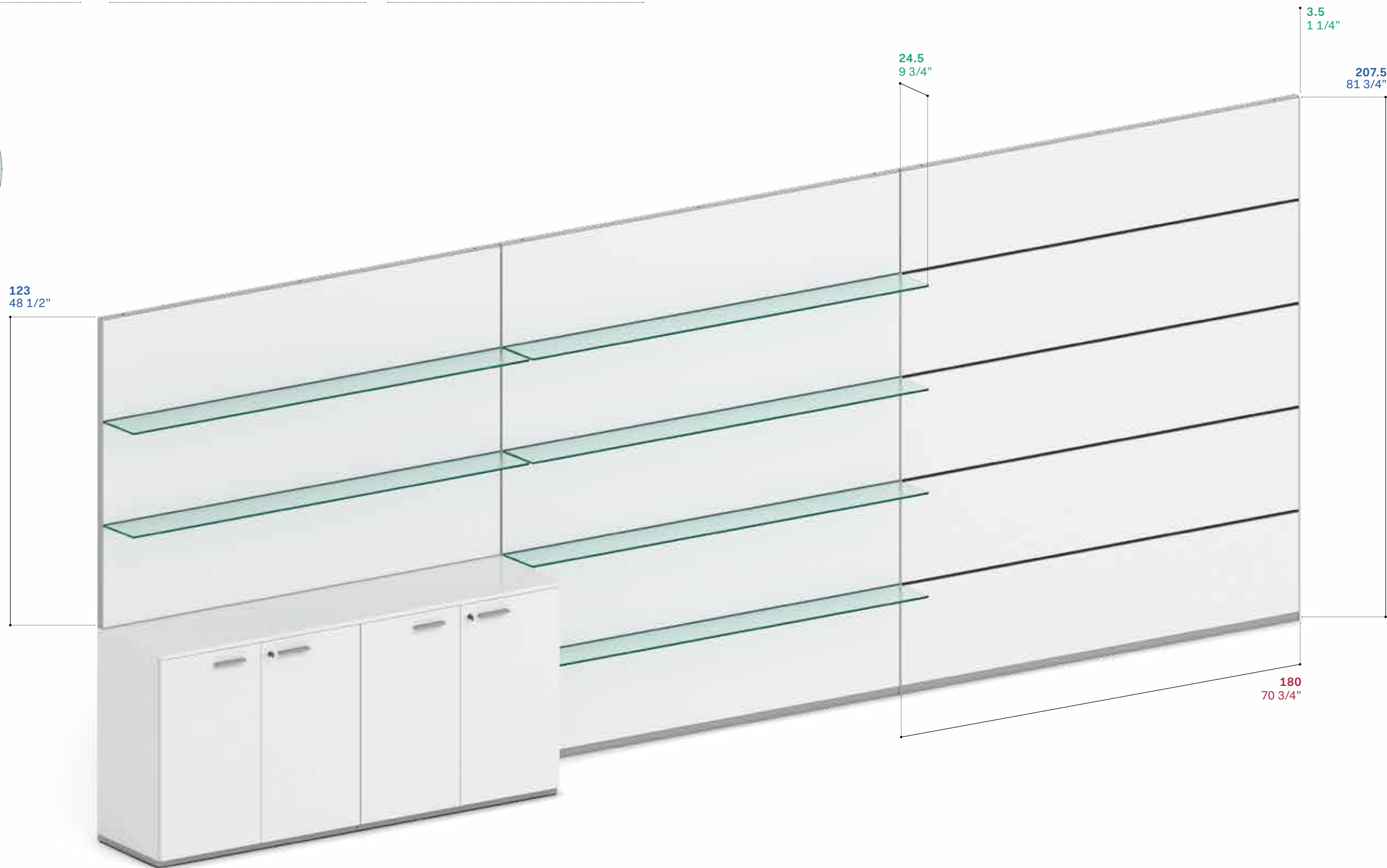
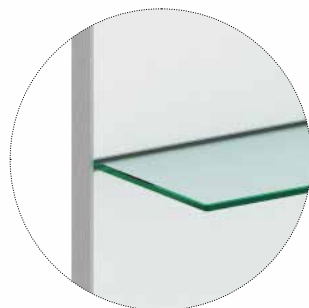

Esempi di composizioni /
Composition examples

Comp. 1



Comp. 4



Comp. 2



Comp. 3



Comp. 5



Comp. 6



Pannelli boiserie/Boiserie panels

Pannelli sp. 1.8 cm, in melaminico (*) o laminato (**)/Panels 1.8 cm thick, in melamine (*) or laminate (**)

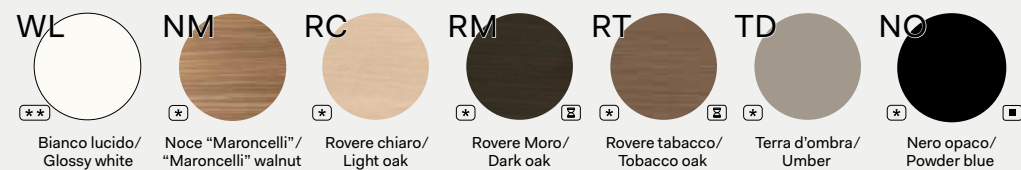

Pannelli sp. 1.8 cm, in impiallacciato/Panels 1.8 cm thick, veneered

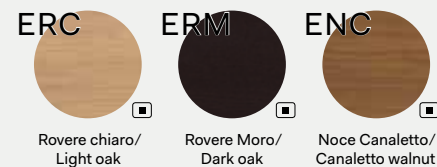

Mensole vetro / Glass shelves

Mensole sp. 0.8 cm, in vetro temprato/Shelves 0.8 cm thick, tempered glass



Profili e zoccoli/Profiles and base frames

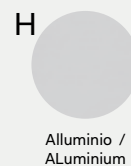

Note

■ Prodotti non in pronta consegna. Per la disponibilità contattare l'ufficio commerciale/Items not in prompt delivery. Please contact the commercial department to check availability.

☒ Fino ad esaurimento. / Until exhaustion.

Boiserie

L 180 P 1,8 x H 207,5 L 180 P 1,8 x H 123 L 179 P 24 x H 0,8 L 180 P 24,5 x H 207,5 L 180 P 24,5 x H 123



530.CB.TR.18_

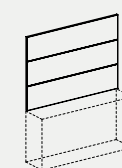

530.CB.SP.18_

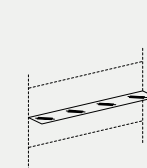

530.CB.RV.18_



530.CB.T1.18_

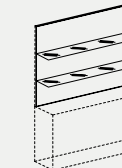

530.CB.S1.18_

Esempi di composizione/Examples of composition

L 180 P 45 x H 207,5

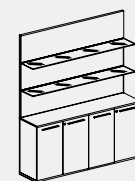

L 270 P 45 x H 209,3

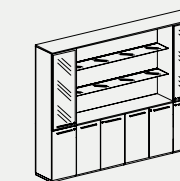
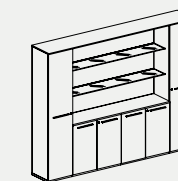
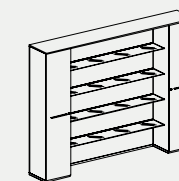

Note:

☒ La finitura impiallacciato non è in pronta consegna. Per la disponibilità contattare l'ufficio commerciale /Veneered finish is not in prompt delivery. Please contact the commercial department to check availability;

☒ Le dimensioni sono espresse in cm – consultare il listino prezzi per le caratteristiche tecniche, i codici degli articoli e delle finiture/Dimensions are stated in cm – for technical characteristics, article code numbers and finishing see price list;

■ Prodotti non in pronta consegna. Per la disponibilità contattare l'ufficio commerciale/Items not in prompt delivery. Please contact the commercial department to check availability.

DV545 Seul

Design:
Antonio Morello

IT I “Contenitori con ante scorrevoli”, disponibili in diverse tipologie dimensionali, completano ed arricchiscono la famiglia dei prodotti destinati all’archiviazione. In evidenza la qualità, la pulizia formale di scocche e ante dotate di un efficiente e ricercato sistema di scorrimento su binario con apertura-chiusura “soft-closing”.

EN The “Storage units with sliding doors” are available in different dimensions; they complete and enrich the range of items dedicated to archiving. Standing out are the quality, the clean lines of bodies and doors, that are equipped with an efficient and sophisticated “soft-opening and closing” rail system.



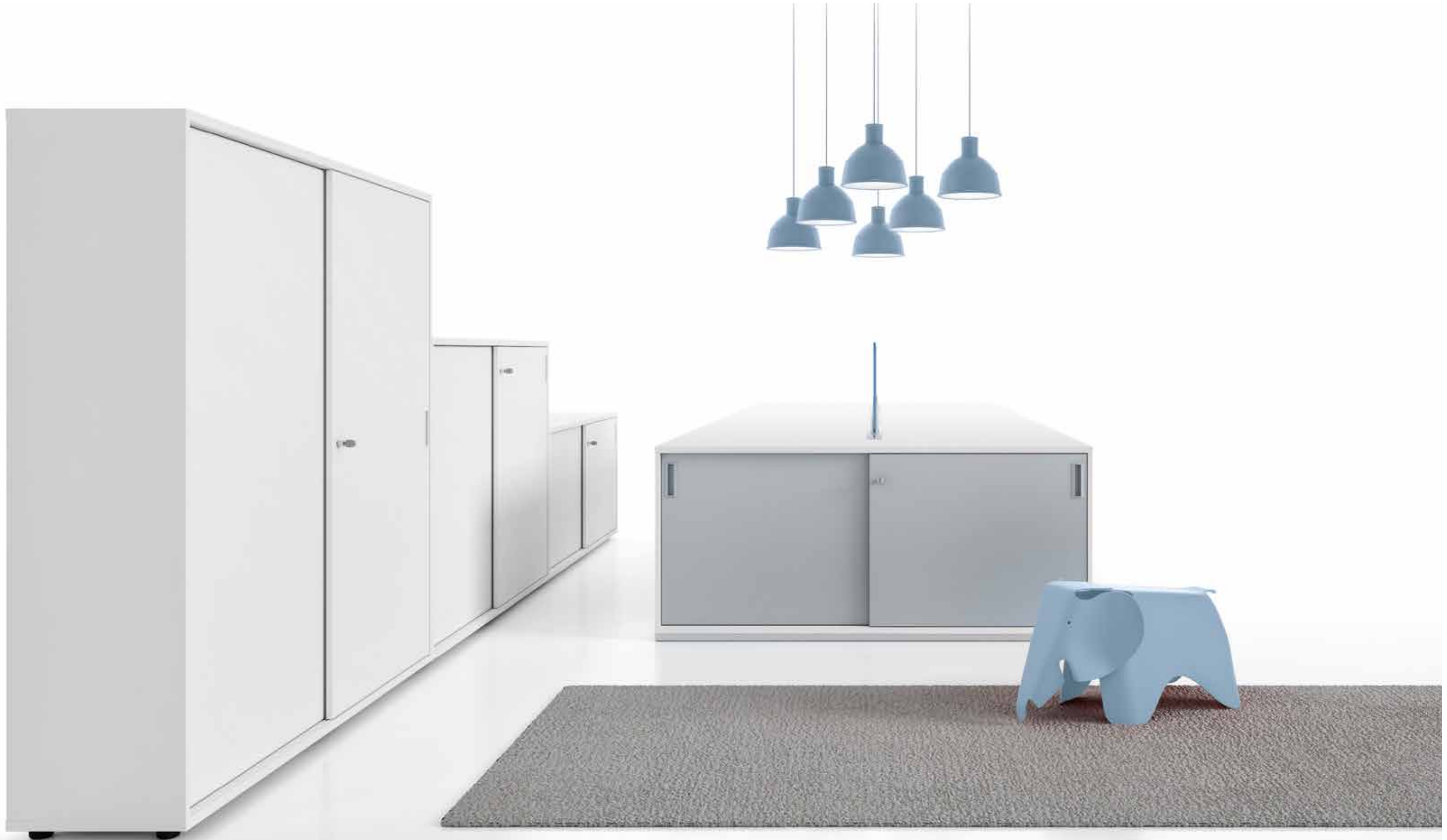

Contenitori ante scorrevoli / Storage units sliding doors

Altezza	Height	Larghezza	Width	Profondità	Depth
A - 74 cm	H - 29 1/4"	L - 136.5 cm	W - 53 3/4"	P - 40.5 cm	D - 16"
A - 115 cm	H - 45 1/4"	L - 166.5 cm	W - 65 1/2"		
A - 164.5 cm	H - 64 3/4"				

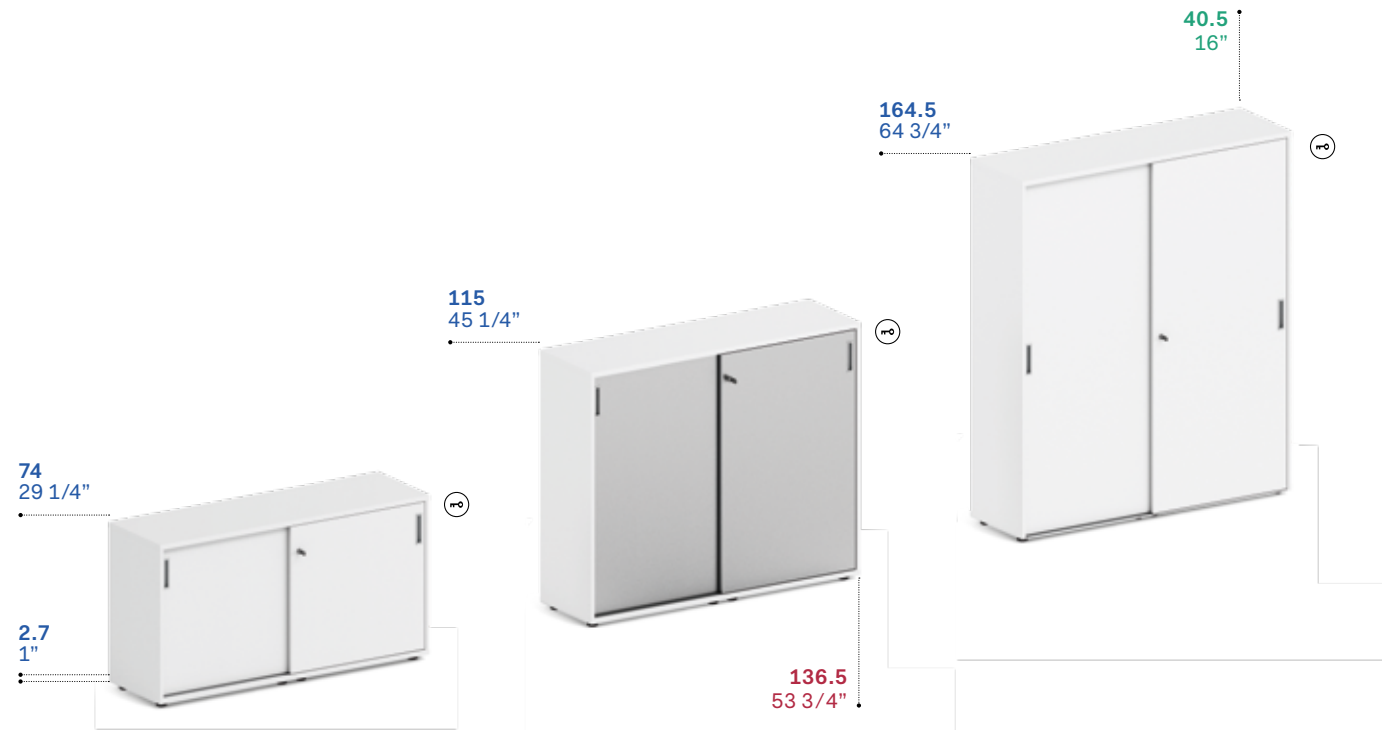

☞ Con serratura / With lock

Capacità contenitiva / Storage capacity

14 Dox
L: 136.5 - W: 53 3/4"

18 Dox
L: 166.5 - W: 65 1/2"

28 Dox
L: 136.5 - W: 53 3/4"

36 Dox
L: 166.5 - W: 65 1/2"

42 Dox
L: 136.5 - W: 53 3/4"

54 Dox
L: 166.5 - W: 65 1/2"



Note: Portata singolo ripiano: Kg 20 / Portata massima di ogni contenitore: Kg 180 / Portata massima di ogni contenitore: Kg 180 / Single shelf reach: 44 lbs. / Maximum static load of each storage unit: 396 lbs. / Maximum static load of each storage unit: 396 lbs.

Zoccolo / Metal base (Optional)

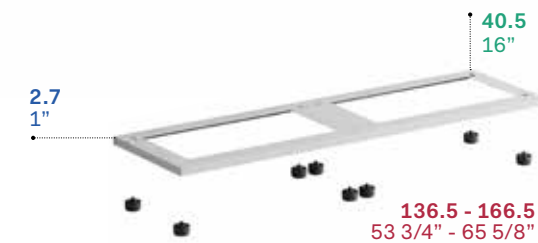

Note: Tutti i contenitori si possono completare con gli zoccoli metallici (Optional) / All storage units can be completed with metal bases (Optional)

Esempi di composizioni con DV807 e DV801 /
Composition examples with DV807 and DV801

Altezza	Height	Larghezza	Width	Profondità	Depth
1 A - 74 cm	H - 29 1/4"	L - 136.5 cm	W - 53 3/4"	P - 40.5 cm	D - 16"
2 A - 115 cm	H - 45 1/4"	L - 166.5 cm	W - 65 1/2"	P - 40.5 cm	D - 16"

Comp. 1



Comp. 2



☑ Con serratura /
With lock

Contenitori / Storage units

Scocca sp. 1.8 cm, in melaminico / Body 1.8 cm thick, in melamine

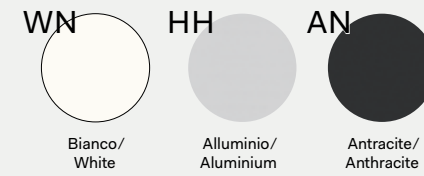

Ante scorrevoli sp. 1.8 cm, in melaminico con bordo ABS sp. 0.15 cm colore alluminio / Sliding doors 1.8 cm thick, in melamine with aluminium-coloured ABS edge-profiles 0.15 cm thick

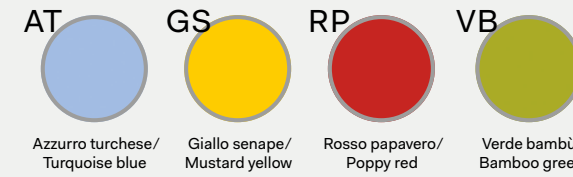

Ante scorrevoli sp. 1.8 cm, in melaminico con bordo ABS sp. 0.15 cm in tinta / Sliding doors 1.8 cm thick, in melamine with ABS edge-profiles 0.15 cm thick, in same color



Note

☒ Fino ad esaurimento/Until exhaustion.

Contenitori ante scorrevoli / Sliding doors storage units

P 40,5 x H 74
☑ ☒

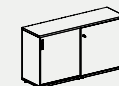

545.CA.S1.13_L 136,5
545.CA.S1.16_L 166,5

P 40,5 x H 115
☑ ☒

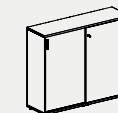

545.CA.S2.13_L 136,5
545.CA.S2.16_L 166,5

P 40,5 x H 164,5
☑ ☒

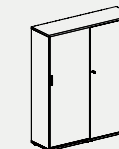

545.CA.S3.13_L 136,5
545.CA.S3.16_L 166,5

Zoccoli metallici / Metal base frames

P 40,5 x H 2,8
☑

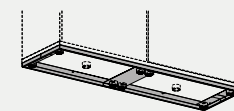

545.ZZ.01.13 L 136,5
545.ZZ.01.16 L 166,5

Note:

☑ Le dimensioni sono espresse in cm - consultare il listino prezzi per le caratteristiche tecniche, i codici degli articoli e delle finiture / Dimensions are stated in cm - for technical characteristics, article code numbers and finishing see price list;

☑ Tutti gli articoli della serie DV545 - Ante scorrevoli non sono in pronta consegna. Per la disponibilità contattare l'ufficio commerciale / All the items of the DV545 - Sliding doors series are not in prompt delivery. Please contact the commercial department to check availability;

☑ Con serratura / With lock.

DV549 Lockers

Design:
Antonio Morello

IT I “Lockers” sono dei pratici e utili contenitori destinati a diversi ambienti di lavoro in cui si presenta la necessità di contenere o custodire documenti ed effetti personali. Modulari e componibili, essi si possono adattare secondo le svariate richieste del cliente. Attuali, freschi, giocosi, diventano eleganti e riconoscibili soprattutto nelle versioni con le ante colorate: disponibili con serrature in diverse tipologie e con numeri integrabili.

EN The “Lockers” are practical and useful storage units for different working environment where the keeping or warding of documents and personal belongings is needed. Modular units, adaptable to various needs of each customer. Topical, fresh, playful, they become elegant and recognizable especially in the version with coloured doors, available with different types of locks and possibility of integrating numbers.

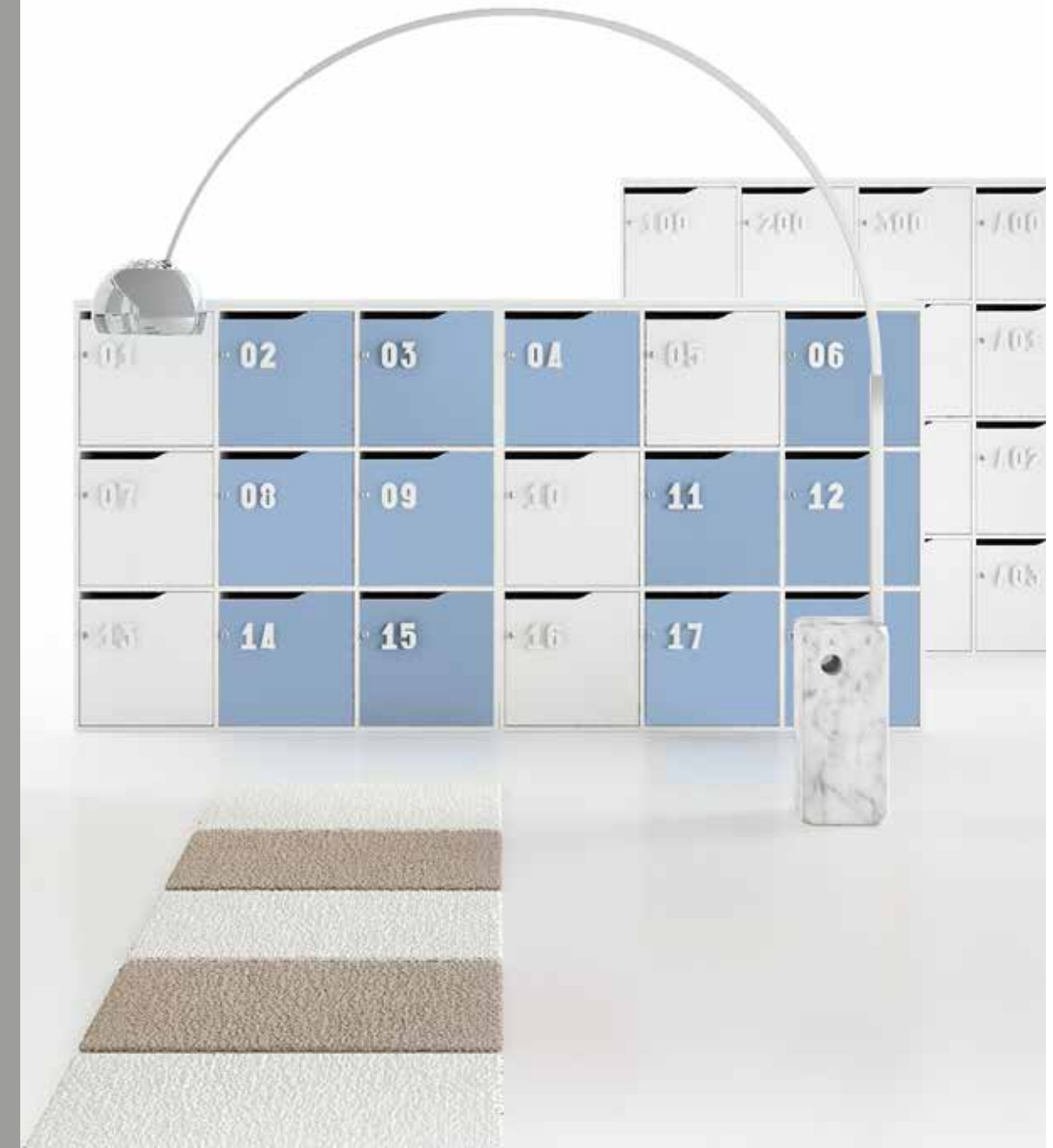





Lockers

Altezza		Height		Larghezza		Width		Profondità		Depth	
⊕	A - 144.6 cm	⊕	H - 57"	⊕	L - 142.3 cm	⊕	W - 56"	⊕	P - 45.2 cm	⊕	D - 17 3/4"
⊕	A - 191.5 cm	⊕	H - 75 2/4"	⊕	L - 189 cm	⊕	W - 74 2/4"	⊕	P - 47 cm	⊕	D - 18 2/4"

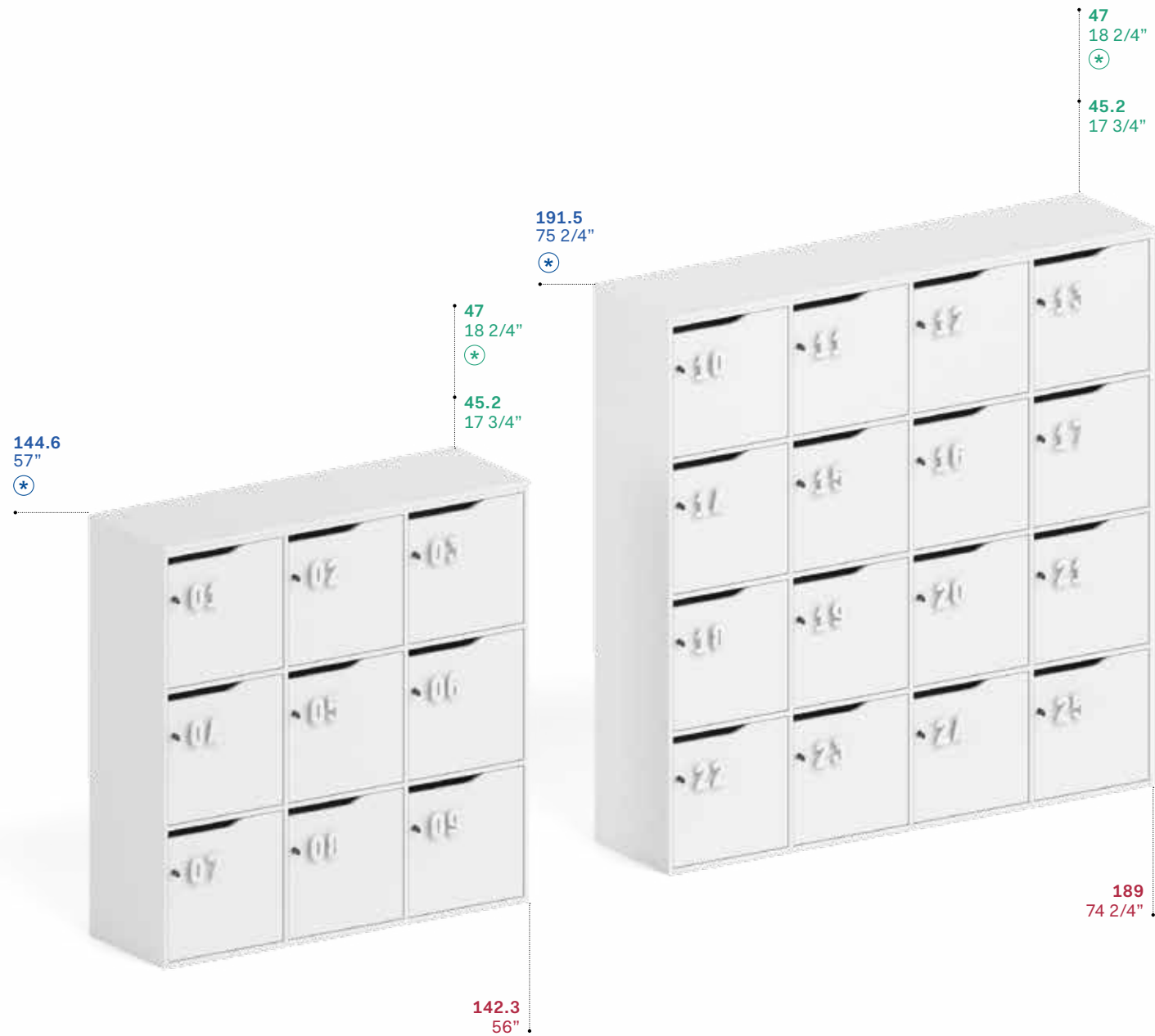

⊕ Profondità scocca più numeri / Body depth including numbers

⊕ Altezza con Top / Height whit Top

Tipologie Lockers / Lockers types

Anta base sp. 1.8 cm con serratura / Basic door 3/4" thick with lock



Anta base sp. 1.8 cm con serratura con combinazione a 4 cifre (Optional) / Basic door 3/4" thick, with lock and 4 digit combination (Optional)

Numeri / Numbers

Numeri disponibili da aggiungere, alle ante già predisposte, in base alla composizione scelta / Available numbers to be added to the doors, already set up depending on chosen combination



Tipologie Lockers /
Lockers types



Tappetino antiscivolo
sp. 1.5 mm (Optional) /
Anti-slip mat 0.06" (Optional)

Tipologie di tops /
Tops types

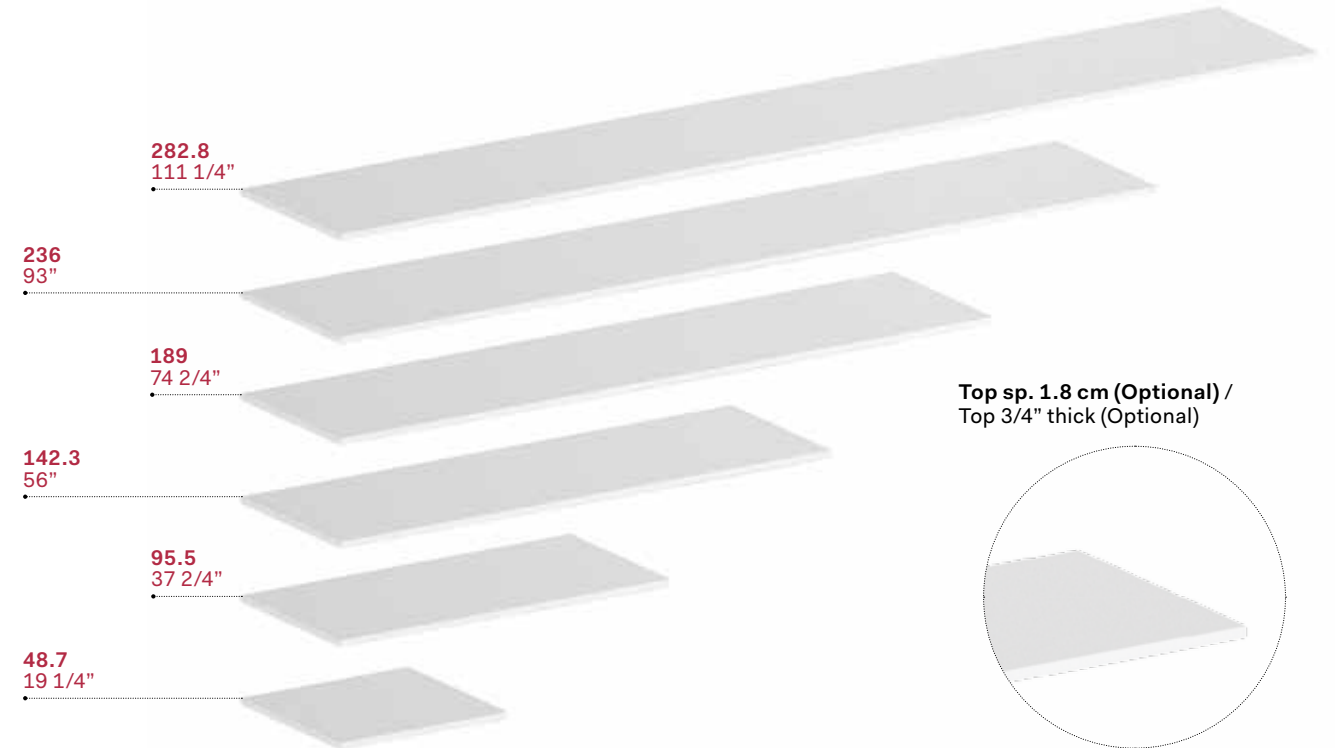

Contenitori/Storage units

Scocca, ripiani e top sp. 1.8 cm, in melaminico/Body, shelves, top 1.8 cm thick, in melamine

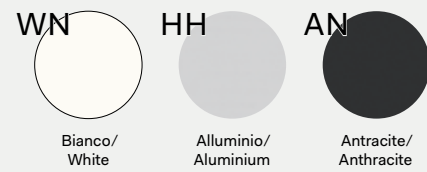

Ante sp.1.8 cm, in melaminico con bordi perimetrali in ABS sp. 0.15 cm colore bianco/Doors 1.8 cm thick, in melamine with white-coloured 0.15 cm ABS edge-profiles

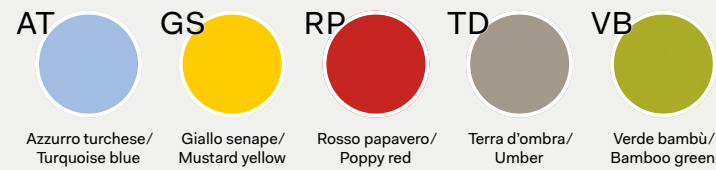

Ante sp. 1.8 cm, in melaminico con bordo ABS sp. 0.15 cm in tinta/Doors 1.8 cm thick, in melamine with ABS edge-profiles 0.15 cm thick, in same color

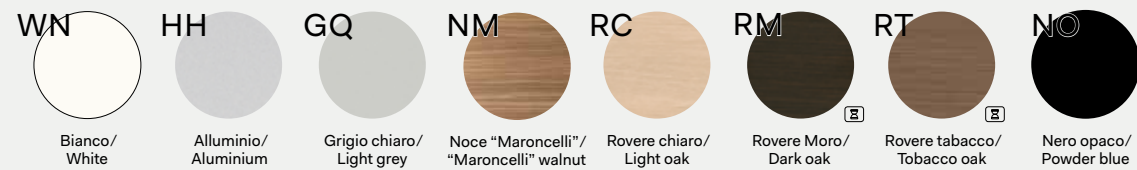

Note

☒ Fino ad esaurimento. / Until exhaustion.

Lockers

L 48,5 P 45 x H 142,8 L 46,8 P 45 x H 142,8 L 48,5 P 45 x H 189,6 L 46,8 P 45 x H 189,6 L 142,3 P 45 x H 142,8 L 189 P 45 x H 189,6 P 45 x H 1,8

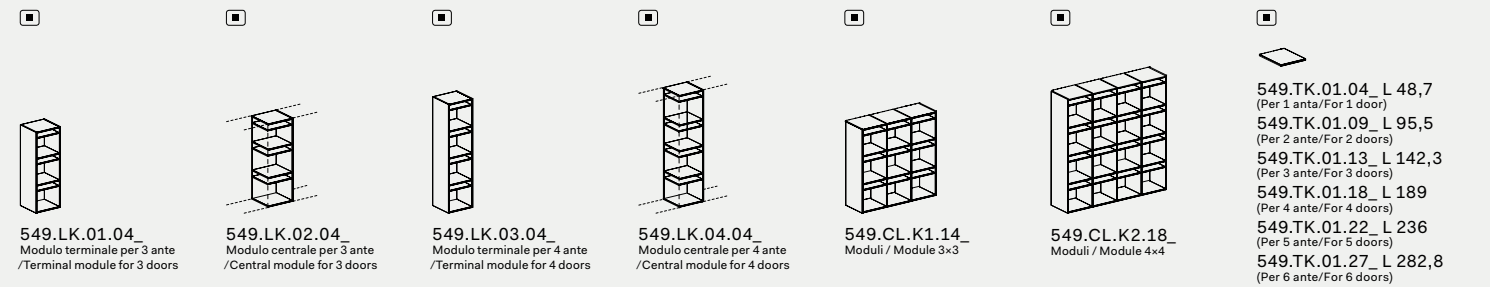

Note: ☒ Per l'integrazione dei TOP vedi "Manuale Tecnico"/Check the "Technical book" for the integration of TOP

Tipologia di ante/Type of doors

L 45 P 1,8 x H 45

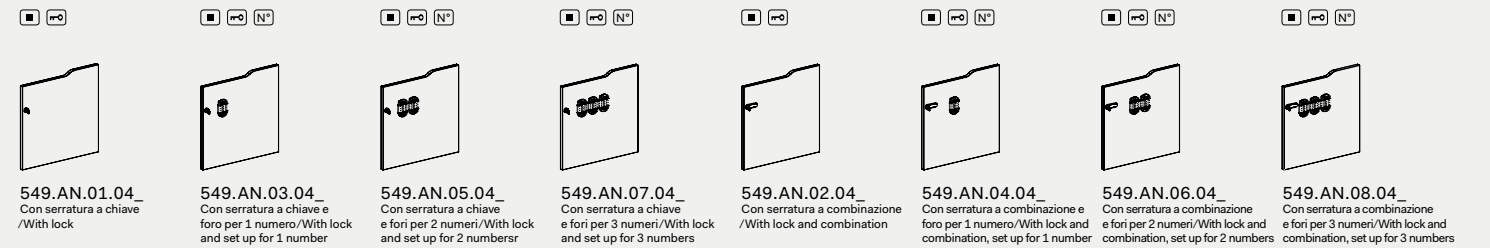

N° Numeri da aggiungere all'ordine/Numbers to be added to the order

Accessori/Accessories



L 45 P 40,5 x H 0,15

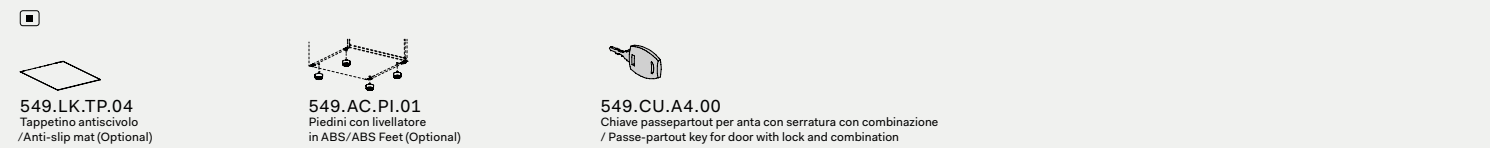

Note:

① Le dimensioni sono espresse in cm – consultare il listino prezzi per le caratteristiche tecniche, i codici degli articoli e delle finiture/Dimensions are stated in cm – for technical characteristics, article code numbers and finishing see price list;

☒ Tutti gli articoli della serie DV549-LOCKERS non sono in pronta consegna. Per la disponibilità contattare l'ufficio commerciale/All the items of the DV549-LOCKERS series are not in prompt delivery. Please contact the commercial department to check availability;

☒ Con serratura/With lock.

DV550 Cassettiere / Pedestals

Design:
Antonio Morello

IT Le “cassettiere universali” sono disponibili in versione melaminico, laminato, impiallacciato e metallo. Sono previsti specifici accessori per l’attrezzatura dei cassetti interni.

EN The “universal pedestals” are available in melamine, laminate, veneered and metal versions and can be completed with useful specific accessories to tidy the drawer space.



























**Cassettiere universali /
Universal pedestals**

Altezza	Height
A - 55.5 cm	H - 21 3/4"    
A - 55.6 cm	H - 22" 

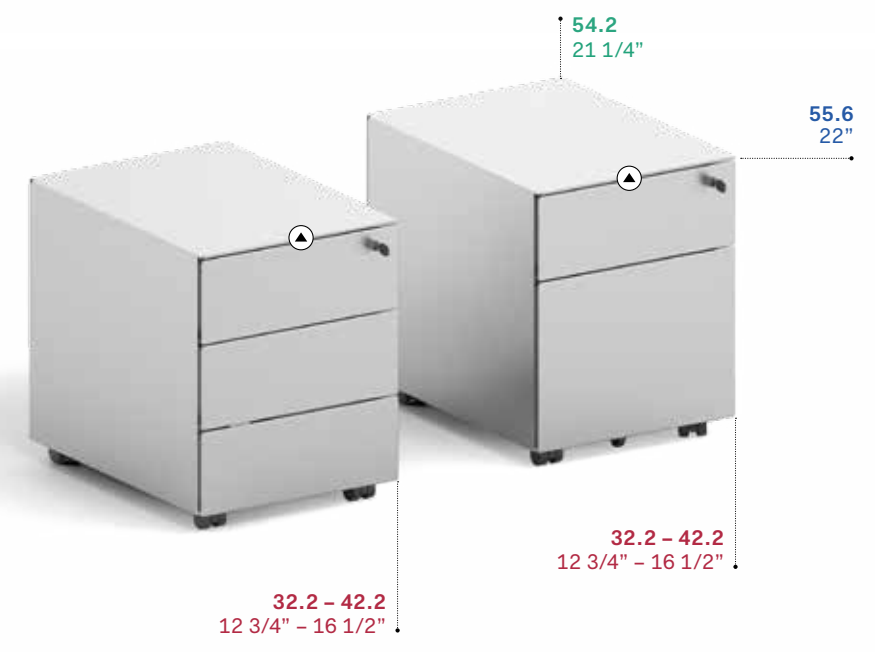
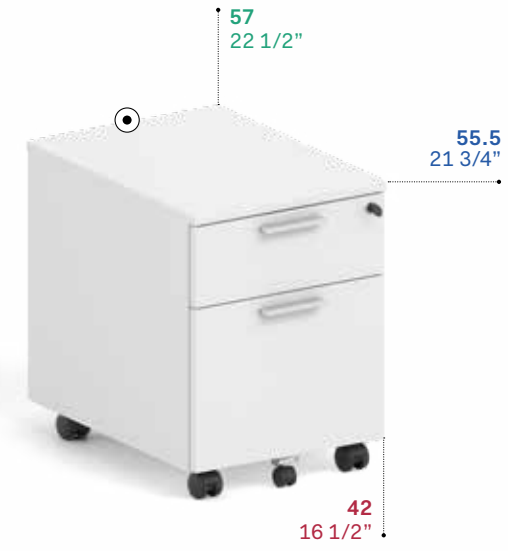
Larghezza	Width
L - 42 cm	W - 16 1/2"    
L - 32.2 cm	W - 12 3/4" 
L - 42.2 cm	W - 16 1/2" 

Profondità	Depth
P - 57 cm	D - 22 1/2"    
P - 54.2 cm	D - 21 1/4" 



-  Melaminico / Melamine
-  Laminato / Laminate
-  Impiallacciato (su richiesta) / Veneered (on request)
-  Metallo / Metal

Cassettiere in finitura Melaminico Laminato Impiallacciato /
 Finish pedestals Melamine Laminate Veneered

Cassettiera su ruote 3 cassetti /
 Pedestals on castors with 3 drawers



Noce "Maroncelli" /
 "Maroncelli" Walnut

Rovere Tabacco /
 Tobacco oak

Grigio Chiaro /
 Light grey

Nero opaco /
 Matt black

Cassettiera su ruote, 2 cassetti di cui 1 classificatore /
 Pedestals on castors with 2 drawers, 1 of which for hanging folders



Rovere Chiaro /
 Light oak

Bianco opaco /
 Matt white



Bianco lucido /
 Glossy white

Cassettiera in laminato
 Laminate Pedestals

Fino ad esaurimento. / Until exhaustion.

**Ruote /
 Castors**

Standard

Optional



Ruote in nylon nere
 H: 6 cm - Ø 5 cm /
 Black nylon castors
 H: 2 1/4" - Ø 2"

Ruote in alluminio e gomma bianca
 H: 7.75 cm - Ø 6 cm /
 Aluminium and white rubber castors
 H: 3" - Ø 2 1/4"

Cassettiere in metallo /
 Metal pedestals

Cassettiera su ruote, 2-3 cassetti di cui 1 classificatore /
 Pedestal on castors, with 2-3 drawers 1 of which for hanging folders



Finitura bianco /
 White finish

Finitura alluminio /
 Aluminium finish

Cassettiera su ruote, 2-3 cassetti di cui 1 classificatore /
 Pedestal on castors, with 2-3 drawers 1 of which for hanging folders



Finitura antracite /
 Anthracite finish

**Mobile di servizio su ruote /
 Service units on castors**



Ruote in alluminio e gomma bianca
 H: 7.75 cm - Ø 6 cm /
 Aluminium and white rubber castors
 H: 3" - Ø 2 1/4"



Maniglie /
 Handles

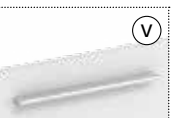

Capacità del cassetto classificatore / Folder drawer capacity

Cassettiera in finitura / Finish Pedestal
 L: 42.2 - W: 16 1/2"



30 Cartella / Folders (A)

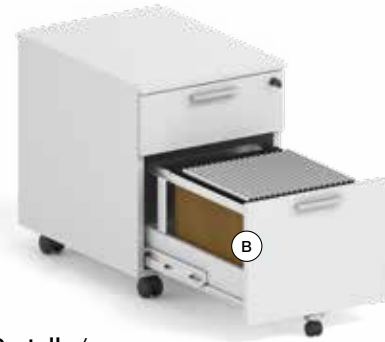

20 Cartella / Folders (B)

Cassettiera in metallo / Metal pedestal
 L: 32.2 - W: 12 3/4"



14 Cartella / Folders (A)

14 Cartella / Folders (B)

Cassettiera in metallo / Metal pedestal
 L: 42.2 - W: 16 1/2"



30 Cartella / Folders (A)

20 Cartella / Folders (B)

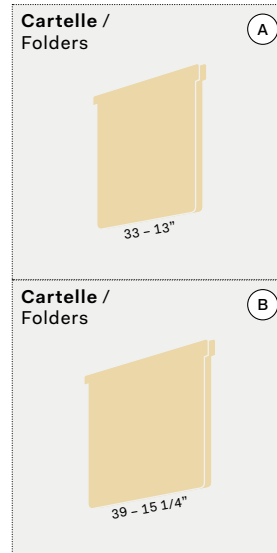

- Melaminico / Melamine
- Laminato / Laminate
- Impiallacciato (su richiesta) / Veneered (on request)
- Metallo / Metal

Cassettiere portanti / Carrying pedestals

Top "Optional":

sp. 1.8 cm - 3/4" thick
sp. 2.5 cm - 1" thick
sp. 3.8 cm - 1 1/2" thick

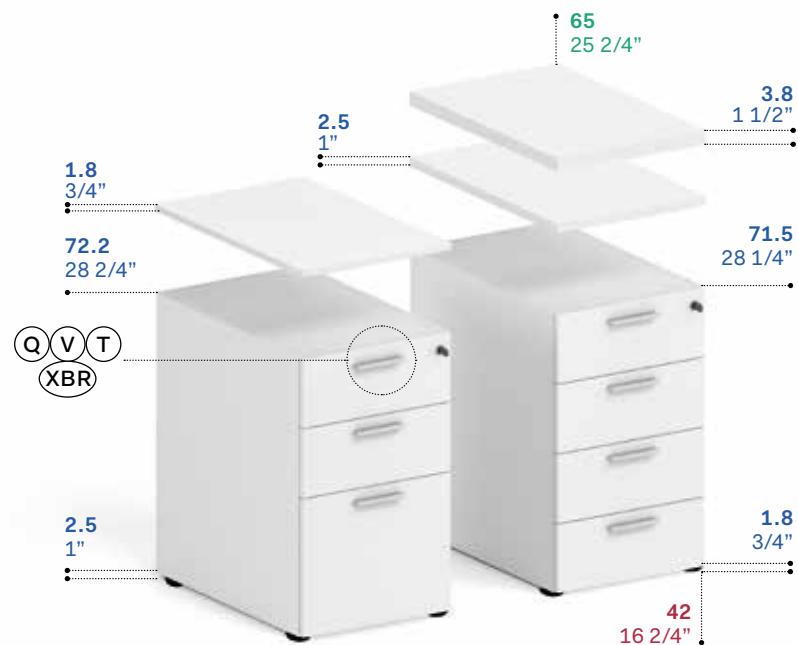

Maniglie / Handles

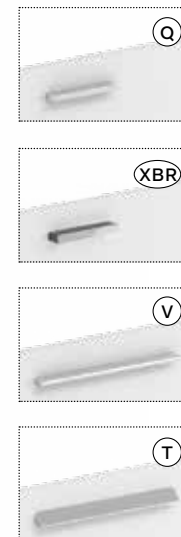

Accessori per contenitori - cassettiere / Accessories for storage units - pedestals



Vaschetta portacancelleria per cassetto (L: 32.2 cm) / Stationary tray for drawers (W: 12 3/4")



Vaschetta portacancelleria per cassetto (L: 42.2 cm) / Stationary tray for drawers (W: 16 2/4")



Cuscino per cassettiera e cuscino per mobile di servizio / Cushion for pedestal and cushion for service unit

DV550 Cassettiere / Pedestals

Finiture cromatiche / Colour finishes

Cassettiere in melaminico (*) o laminato (**)/Pedestals in melamine (*) or laminate (**)



Cassettiere in impiallacciato / Veneered pedestals

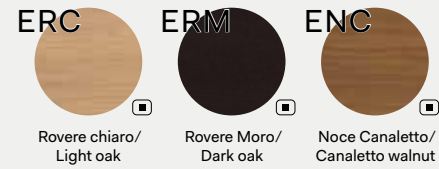

Cassettiere metalliche/Metal pedestals

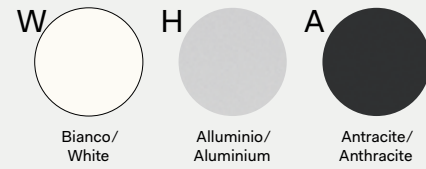

Cassettiere portanti 4 cassetti o 3 cassetti in melaminico/Carrying pedestals in melamine with 4 drawers or 3 drawers



Top. sp. 1.8 - 2.5 - 3.8 cm, in melaminico / Top. 1.8 - 2.5 - 3.8 cm thick, in melamine



Zoccoli in alluminio/Aluminium plinth

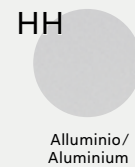

Mobili di servizio su ruote/Service units on castors

Cappello, ante e frontali cassetti sp. 1.8 cm, in melaminico (*) o laminato (**) / Top, doors and drawer fronts 1.8 cm thick, in melamine (*) or laminate (**)

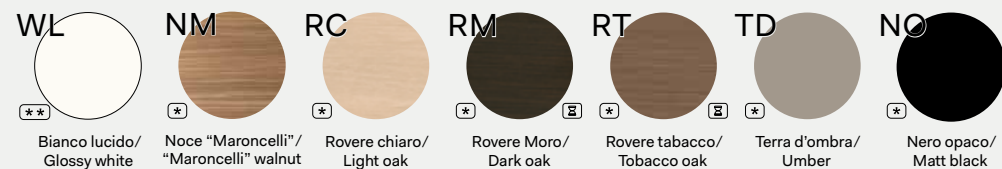

Cappello, ante e frontali cassetti sp. 1.8 cm, in impiallacciato / Top, doors and drawer fronts 1.8 cm thick, veneered

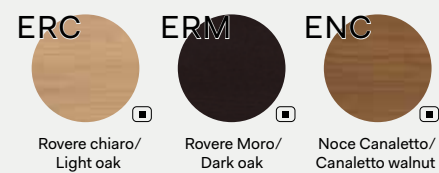

Scocca in melaminico colore alluminio / Melamine body in aluminium finish

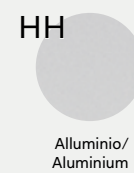

Note

■ Prodotti non in pronta consegna. Per la disponibilità contattare l'ufficio commerciale / Items not in prompt delivery. Please contact the commercial department to check availability.

Ⓜ Fino ad esaurimento. / Until exhaustion.

DV550 Cassettiere / Pedestals

Finiture cromatiche / Colour finishes

Maniglie/Handles

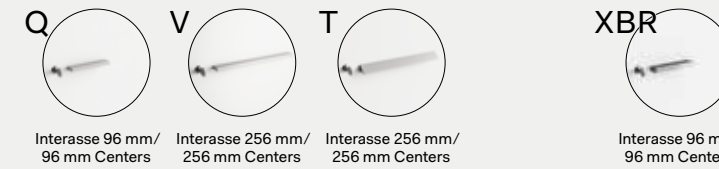
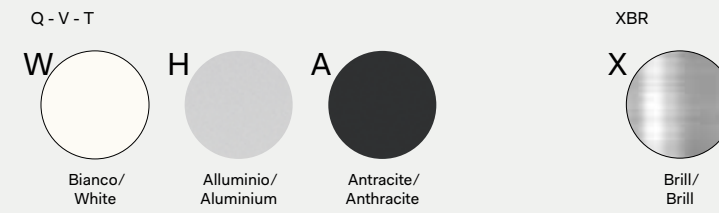

DV550 Cassettiere / Pedestals

Dati tecnici / Technical data

Cassettiere/Pedestals

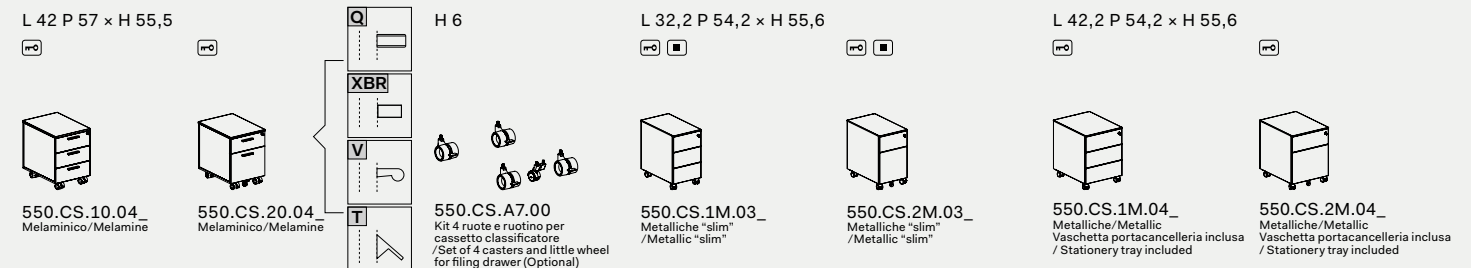

Cassettiere portanti/Carrying pedestals

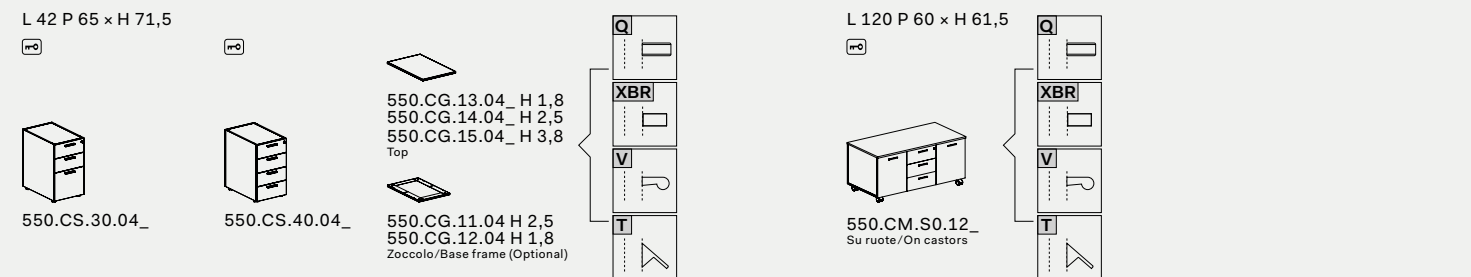

Accessori per cassettiere e contenitori/Accessories for pedestals and storage units

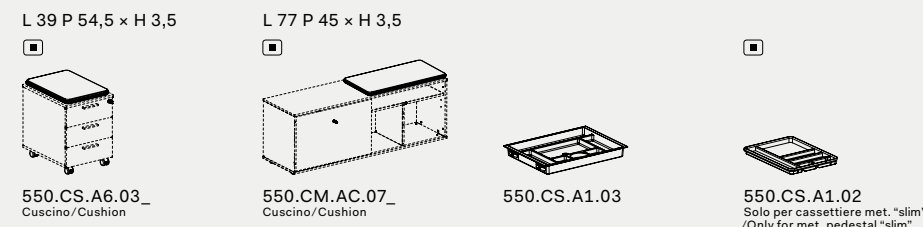

Note:

1 La finitura impiallacciato non è in pronta consegna. Per la disponibilità contattare l'ufficio commerciale / Veneered finish is not in prompt delivery. Please contact the commercial department to check availability;

2 Per portacancelleria cassetti, vedi capitolo DV300-Accessori/For stationary tray, see chapter DV300-Accessories;

3 Le dimensioni sono espresse in cm - consultare il listino prezzi per le caratteristiche tecniche, i codici degli articoli e delle finiture / Dimensions are stated in cm - for technical characteristics, article code numbers and finishing see price list;

■ Prodotti non in pronta consegna. Per la disponibilità contattare l'ufficio commerciale / Items not in prompt delivery. Please contact the commercial department to check availability;

Ⓜ Fino ad esaurimento/Until exhaustion;

🔒 Con serratura/With lock.

Cod.	Pag.
DV300 Byblos	178
DV300 Caffee Tables	184
DV300 Accessories	190

DV300 Accessories

DV300 Byblos

Design:
Antonio Morello

IT Originale lampada a Led integrabile a molteplici nostre serie di tavoli sia direzionali che operativi. Struttura in alluminio e diffusore in metacrilato, molto utile per realizzare tavoli biblioteca.

EN Original Led lamp integrable to many of our series, both in the executive and workstations. Aluminum frame and methacrylate light diffuser, very useful for creating library desks.







Lampada Led in alluminio / Aluminium Led lamp

Altezza
A - 37 cm

Height
H - 14 1/2"



Larghezza
L - 200 cm

Width
W - 78 3/4"



Profondità
P - 14.5 cm

Depth
D - 5 3/4"

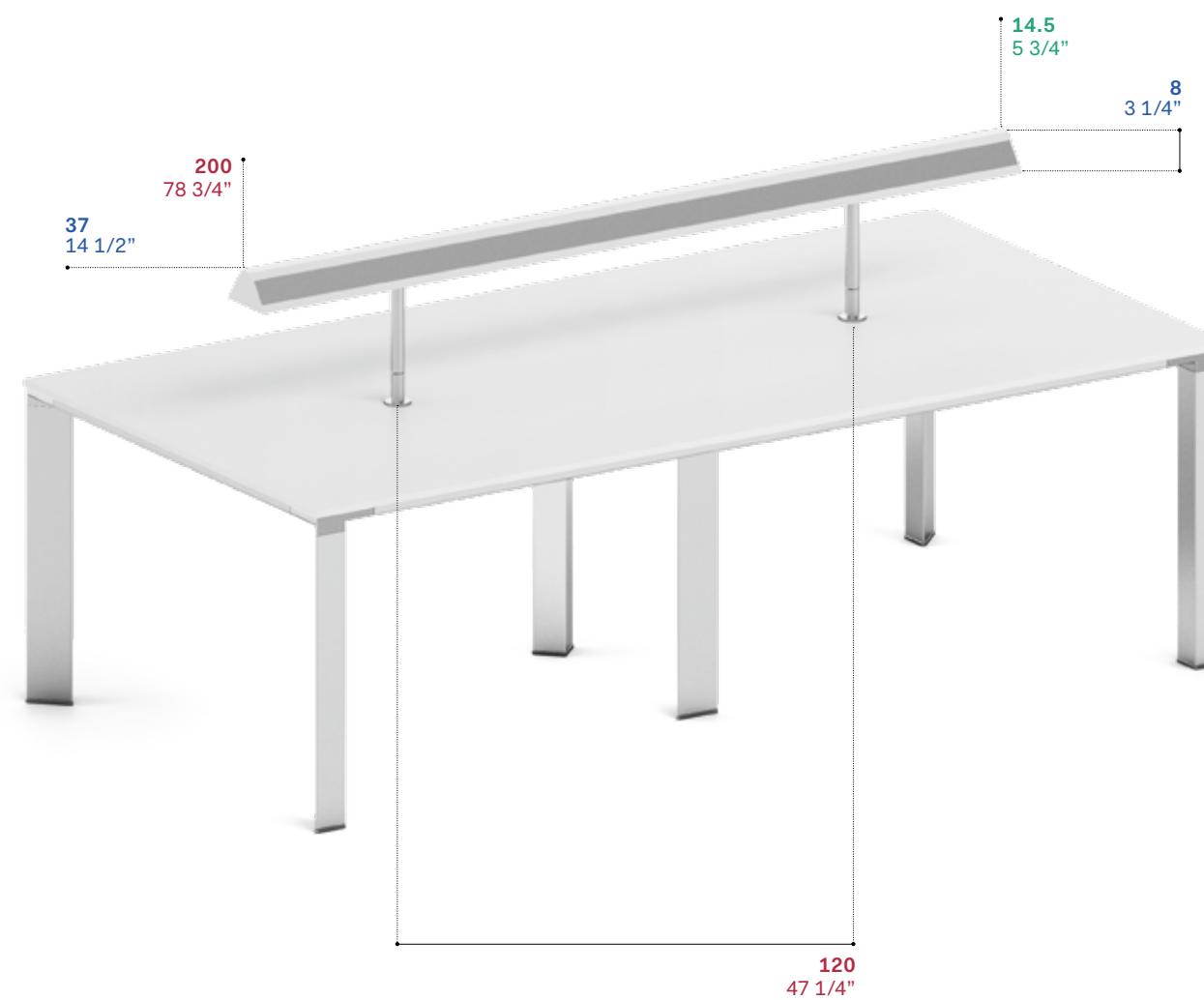

Finiture / Finishes



Alluminio "anodizzato" / Anodized aluminum
Nero "anodizzato" / Anodized black

DV300 Tavolini caffè/ Coffee Tables

Design:
Antonio Morello

IT Famiglia di tavolini caffè e attesa con diverse varianti di piani, gambe e materiali anche di prestigio come il "gres". Adattabili ad ogni tipo di esigenza, situazione e contesto per creare soluzioni d'arredo innovative e sorprendenti.

EN Family of coffee and waiting tables with different variants of tops, legs and materials, including prestigious materials such as "gres". Adaptable to any type of need, situation and context to create innovative and surprising furnishing solutions.





Tavolini caffè /
Coffee tables

A1
Con gambe coniche in Legno /
With Wooden conical legs

A2
Con gambe Metalliche DV804 /
With DV804 Metal legs

A3
Con gambe Metalliche /
With Metal legs



Note: Per tutte le altre finiture consultare i relativi capitoli all'interno del listino prezzi /
For all other finishes, please refer to the relevant chapters in the price list

Tavolini caffè /
Coffee tables

Tavolini caffè con gambe Alluminio /
Coffee tables with Aluminum legs

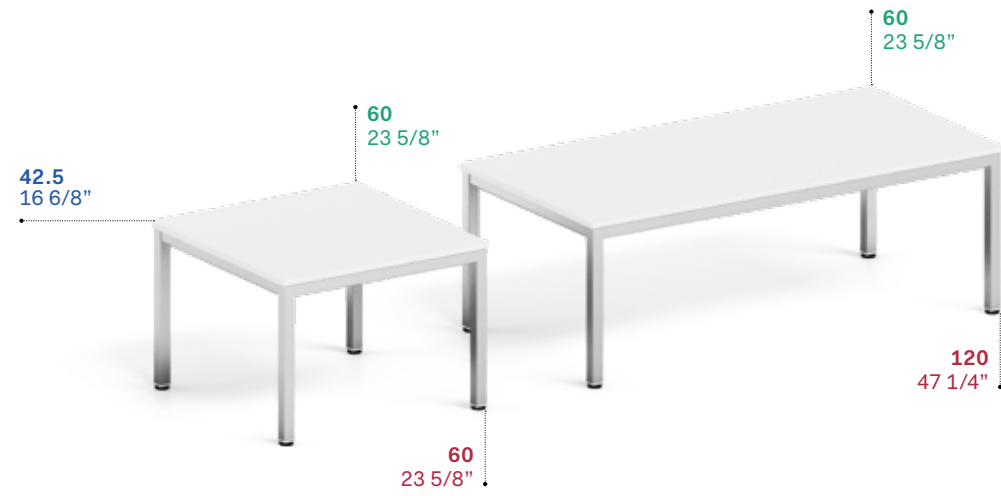

Tavolini caffè con piano in Vetro Acidato e gambe Alluminio /
Coffee tables with Acetated Glass top and Aluminium legs

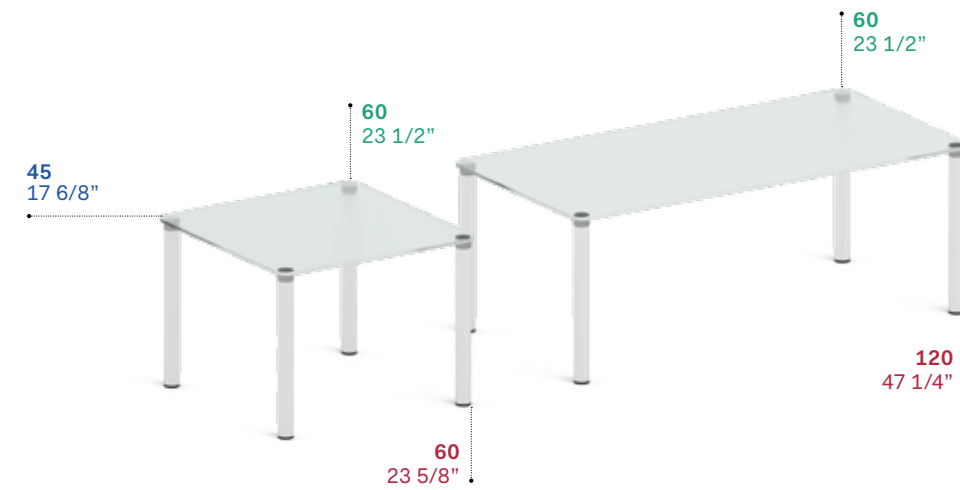

Tavolini caffè con gambe pannellate /
Coffee tables with panelled legs

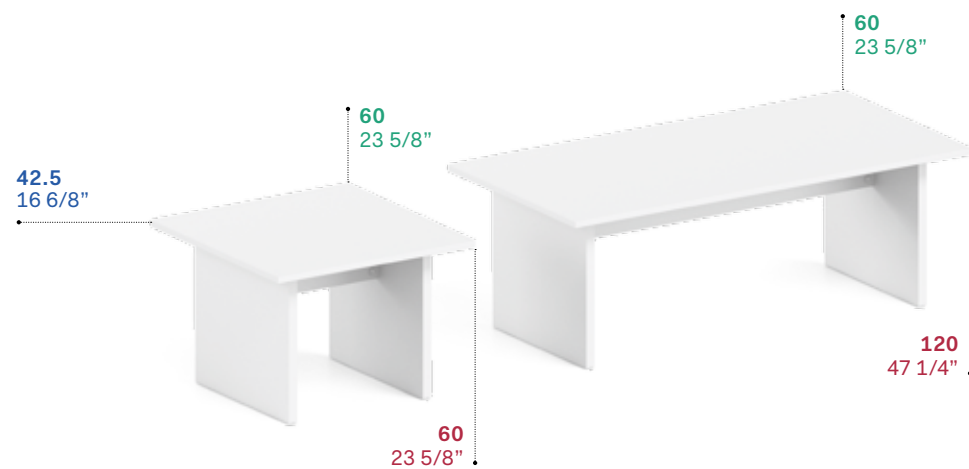

Tavolini caffè con gambe pannellate a "L" e "X", sp. 3.8 cm /
Coffee tables with "L" and "X" panelled legs, sp. 1 1/2" thick

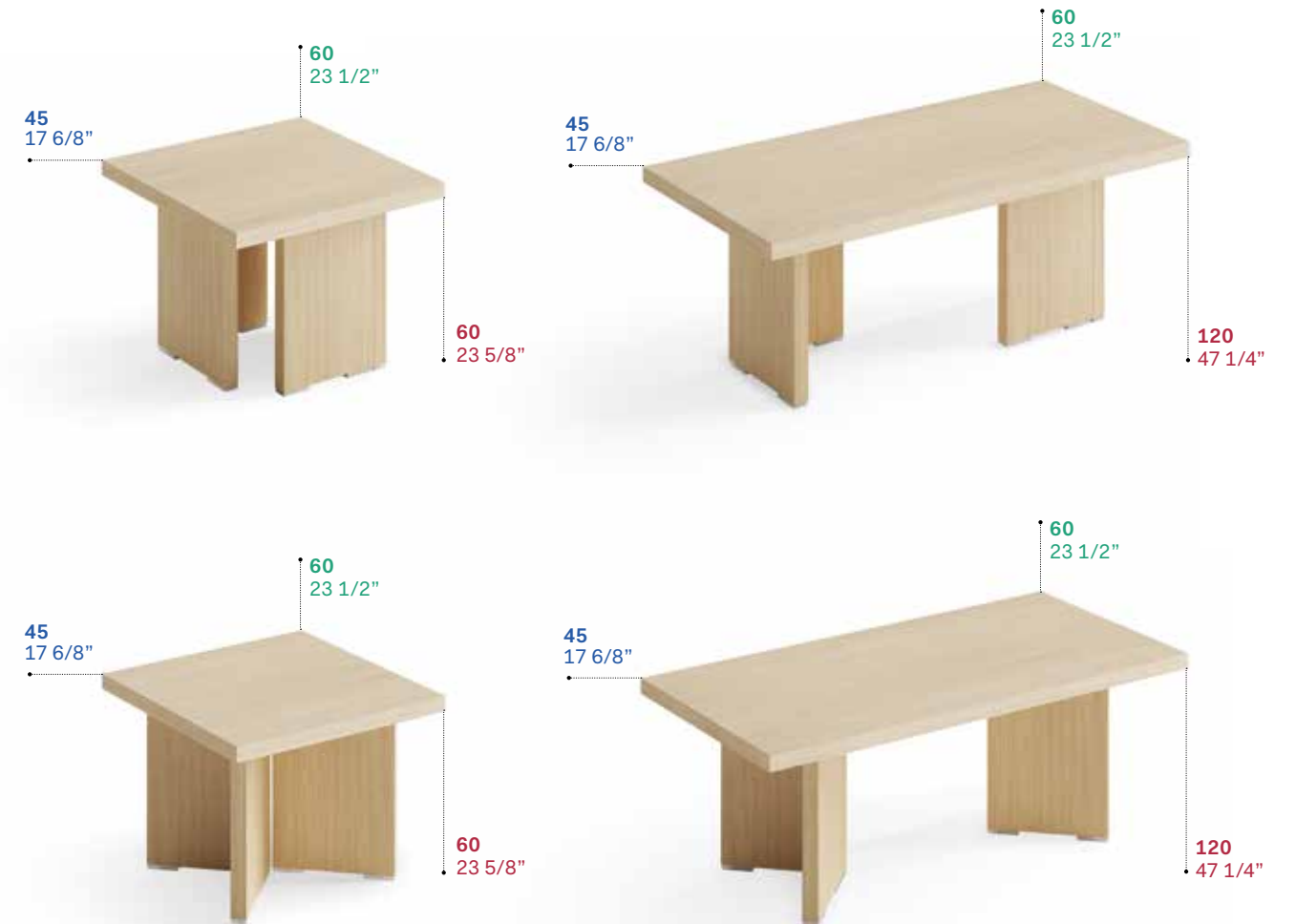

Note: Per tutte le altre finiture consultare i relativi capitoli all'interno del listino prezzi /
For all other finishes, please refer to the relevant chapters in the price list

Note: Per tutte le altre finiture consultare i relativi capitoli all'interno del listino prezzi /
For all other finishes, please refer to the relevant chapters in the price list

Tavoli su gamboni regolabili con sistema pneumatico a pedale /
Table with adjustable column with pneumatic pedal system

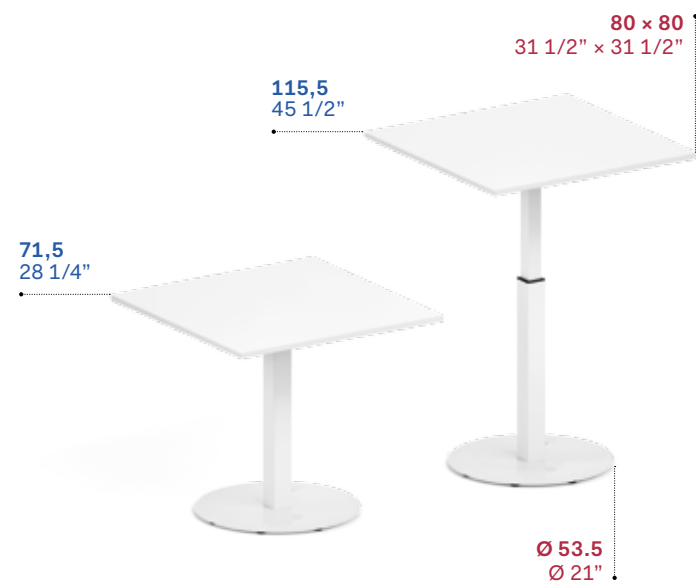
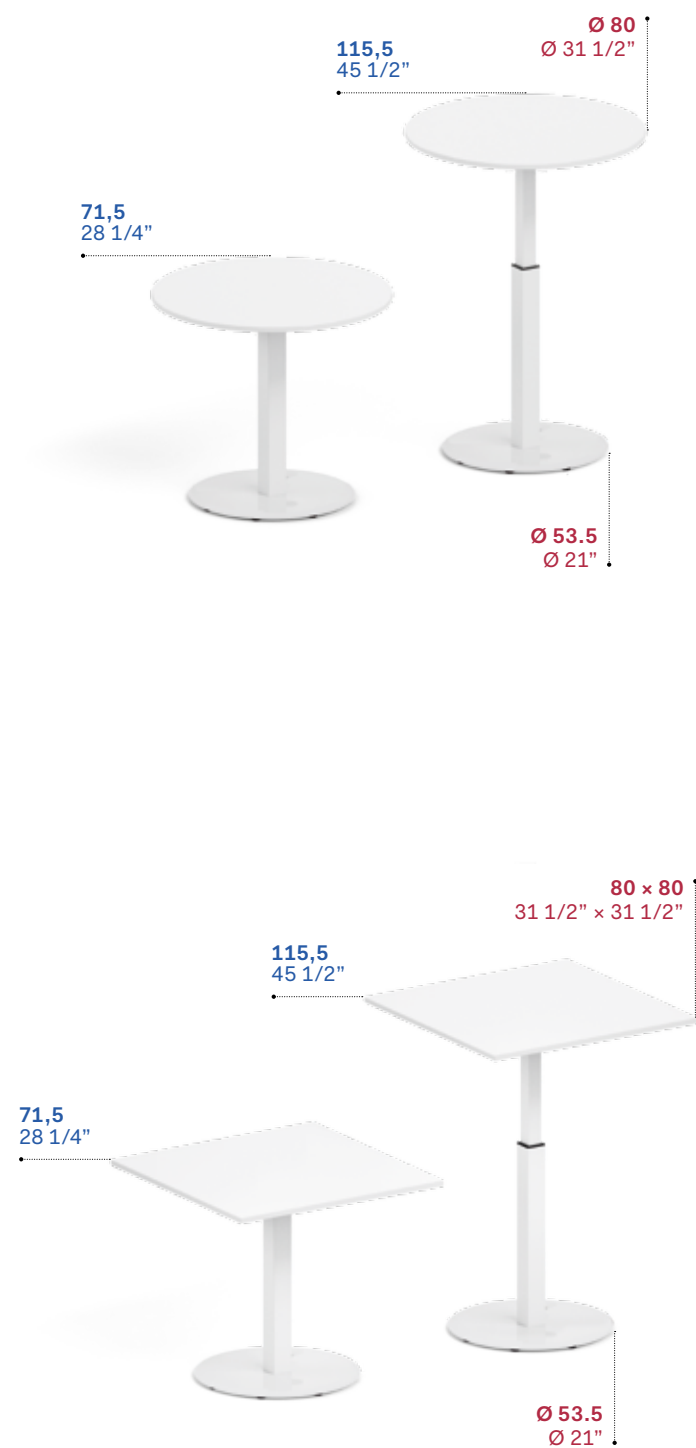

Note: Per tutte le altre finiture consultare i relativi capitoli all'interno del listino prezzi /
For all other finishes, please refer to the relevant chapters in the price list

Tavolo su ruote, accatastabile orizzontalmente, con piano ribaltabile /
Desk on castors, stackable horizontally, with foldable



Modesty panels in tessuto tecnico /
Modesty panels with technical fabric



Note: Per tutte le altre finiture consultare i relativi capitoli all'interno del listino prezzi /
For all other finishes, please refer to the relevant chapters in the price list

**Frontal panel /
Frontal panels**

Frontal panel in vetro stratificato retrolaccato sp. 0.8 cm /
Frontal panel in laminated rear-lacquered glass 1/4" thick

Frontal panel in melaminico sp. 1 cm, con morsetti
/ Frontal panel in melamine 1/4" thick, with clamps



Frontal panel rivestito in tessuto con telaio perimetrale metallico /
Frontal panel covered in fabric with external metal frame



**Frontal panel in melaminico sp. 1 cm /
Frontal panels in melamine 1/2" thick**



**Accessori per "Frontal panel in Melaminico" /
Accessories for "Melamine Frontal panels"**

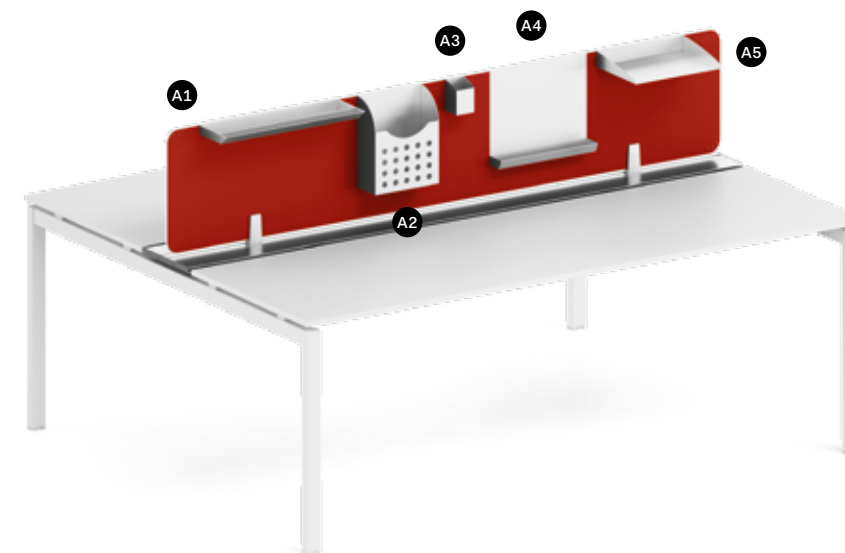

- A1** Vaschetta porta cancelleria colore Alluminio / Aluminium coloured stationery tray
- A2** Tasca verticale colore Alluminio / Aluminium coloured vertical paper holder
- A3** Portapenne colore Alluminio / Aluminium coloured pen holder
- A4** Portanotes con magneti / Board for notes with magnets
- A5** Portafogli singolo colore Alluminio / Aluminium coloured paper holder

Accessori per canalizzazione/elettificazione /
Accessories for wire-management/electrification



Top access in alluminio 2 vie L: 24.5 – 34.5 – 44.5 cm /
2 way aluminium top access W: 9 3/4" – 13 2/4" – 17 2/4"

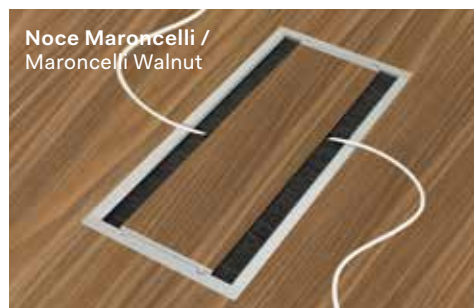

Noce Maroncelli /
Maroncelli Walnut



Rovere chiaro /
Light oak



Rovere moro /
Dark oak



Rovere tabacco /
Tobacco oak

Top access rivestiti nelle finiture lignee (su richiesta) / Top access covered with wooden finishes (on demand)



Top access rivestito in cuoio bianco (su richiesta) /
Top access white leather covered (on demand)



Top access con integrazione multipresa elettrica / Top access with electrical socket integration

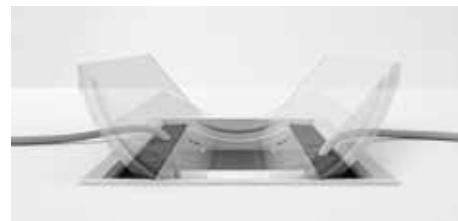

Top access in alluminio bianco e nero /
Top access white and black aluminium



Fino ad esaurimento /
Until exhaustion



Top access in alluminio 1 via (per piani di lavoro spessore max. 3.8 cm) /
1 way aluminium top access (for worktops 1/2" maximum thickness)



Top access elettrificato, in alluminio L: 21 – 25.5 – 39 cm (vedi listino) /
Aluminium wired top access W: 8 1/4" – 10" – 15 3/8" (see price list)



Torretta a scomparsa, aperta e chiusa, con 2 prese Schuko + 2 kit dati / Wired tower system, opened and closed, with 2 Schuko sockets + 2 data outlets



Tappi passacavi / Outlet lids

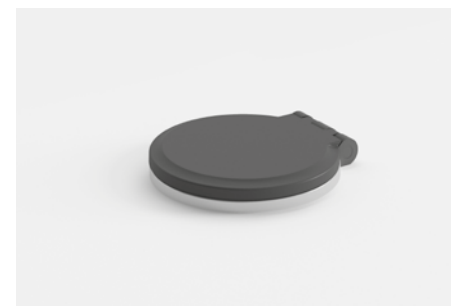

Tappo elettrificato, Ø 8 cm (vedi listino) / Electrified grommets, Ø 3 1/8" (see price list)

Accessori per canalizzazione/elettificazione /
Accessories for wire-management/electrification



Canalina ispezionabile in filo di acciaio /
Inspectable cable channel with aluminium coloured steel rods

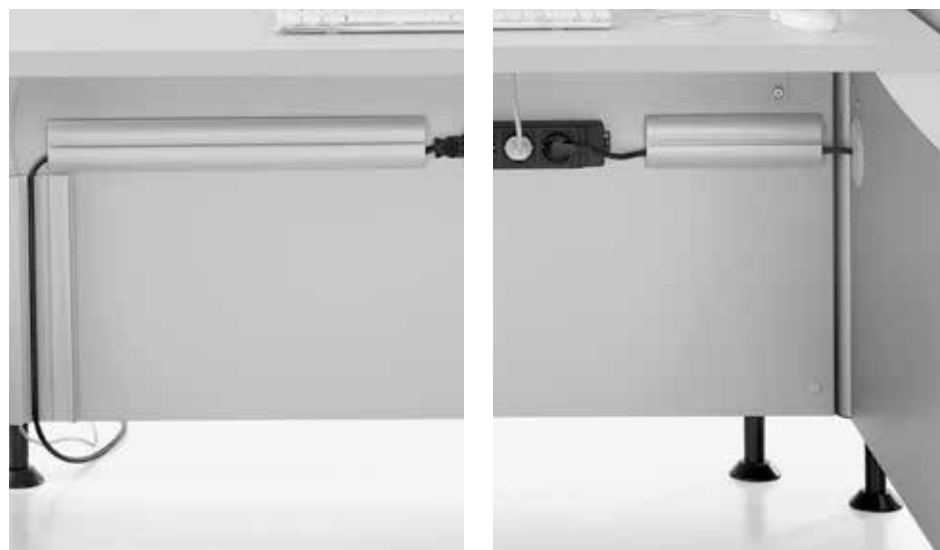

Canalina ispezionabile in PVC /
Inspectable PVC cable channel



Binario con clips fermacavi, per raccordi /
Channel with cables-holder clips, for
connection elements



Canale passacavi ispezionabile in PVC con cerniere in ABS /
Inspectable PVC cable channel with ABS hinges



Canale + vertebra passacavi /
Cable channel and vertebra



Clip passacavi / Cable clips



Colonna passacavi su piedini / Wire column on feet



Vertebra passacavi / Cable vertebra



Colonna metallica passacavi ispezionabile con altezza regolabile da 64 cm - a 73 cm /
Inspectable metallic cable channel column with adjustable height, from 25 1/4" to 28 3/4"



**Bracci porta video /
Arms for video support**



**Braccio porta video mobile su piano /
Draw-out frame for folders for storage**



**Doppio braccio porta video mobile su piano /
2 dynamic arms for video support on deskbase**



**Braccio porta video mobile su piano /
Dynamic arm for video support on deskbase**



**Doppio braccio porta video mobile su piano /
2 dynamic arms for video support on deskbase**



**Braccio porta video statico su palo /
Static arm for video support on deskbase**



**Doppio braccio porta video statico su palo /
2 static arms for video support on pole**



**Braccio porta video statico su palo /
Static arm for video support on pole**



**Doppio braccio porta video statico su palo /
2 static arms for video support on pole**



Accessori vari /
Various accessories



Portadox in lamiera bianco /
Binder holder in white sheet metal



Box multiuso / Storage box



Porta CPU su ruote /
CPU holder on castors



Porta CPU sospeso con cinghie, serie
DV804 E-PLACE (per le altre serie vedi
relativi cataloghi) / CPU holder suspended
with straps series DV804 E-PLACE
(for other series see relevant catalogs)



Mensole con supporti / Shelves with brackets

Complementi /
Complements



Contentore pensile chiuso / Closed hanging storage



Contentore pensile aperto / Open hanging storage



Dettaglio chiave / Key detail



Presca USB sottopiano (2 prese USB, solo ricarica) /
Under-worktop USB socket (2 USB socket, charger only)



Porta penne e mensola in metallo bianco /
White metal pen holder and shelf

DV300 Accessories

Finiture cromatiche / Colour finishes

Frontal panels in vetro stratificato sp. 0.8 cm / Glass frontal panels stratified glass 0.8 cm thick

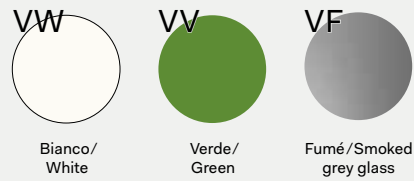

Frontal panels in melaminico / Melamine frontal panels

Frontal panels sp. 1 cm, in melaminico con bordo ABS sp. 0.15 cm colore alluminio / Frontal panels 1 cm thick, in melamine with aluminium-coloured ABS edge-profile 0.15 cm thick



Frontal panels in tessuto / Fabric frontal panels

Rivestimento in lana "Soft" 100%/100% "Soft" wool cover

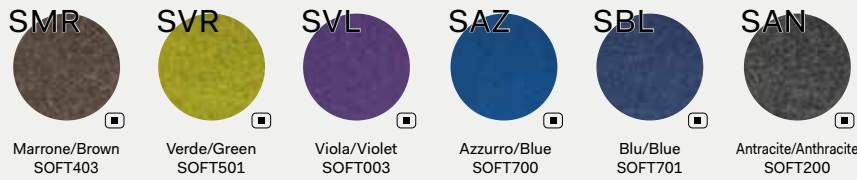

Rivestimento in poliestere / Polyester coating

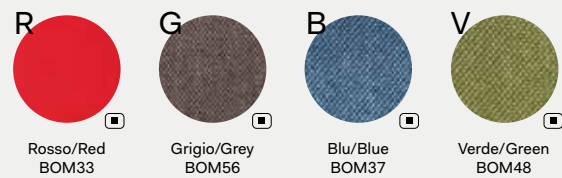

Frontal panels in tessuto acustici / Acoustic fabric frontal panels

Rivestimento in poliestere / Polyester coating

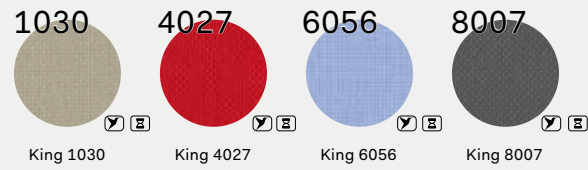

Rivestimento in tessuto 100% poliestere Trevira CS / 100% polyester Trevira CS fabric coating

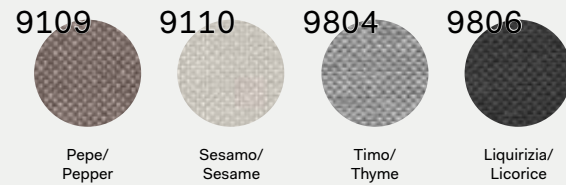

Morsetti e supporti / Clamps and supports

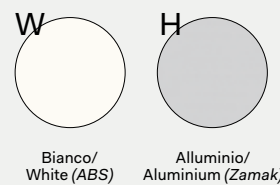

Prodotti non in pronta consegna. Per la disponibilità contattare l'ufficio commerciale / Items not in prompt delivery. Please contact the commercial department to check availability.

Prodotti Colibri / Colibri products.

Fino ad esaurimento. / Until exhaustion.

DV300 Accessories

Dati tecnici / Technical data

Lampade/Lights

L 200 P 14,5 x H 37



300.AC.50.20_

Note: Da integrare ai tavoli riunione / To be integrated with meeting tables

Tavolini caffè / Coffee tables



Tavoli su gamboni regolabili / Tables on adjustable metal column

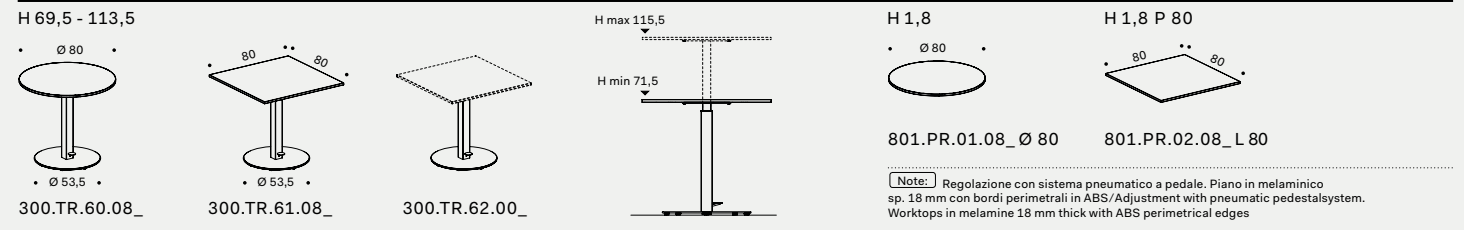

Note: Regolazione con sistema pneumatico a pedale. Piano in melaminico sp. 18 mm con bordi perimetrali in ABS / Adjustment with pneumatic pedestal system. Worktops in melamine 18 mm thick with ABS perimetrical edges

Colonne e gamboni / Metal columns

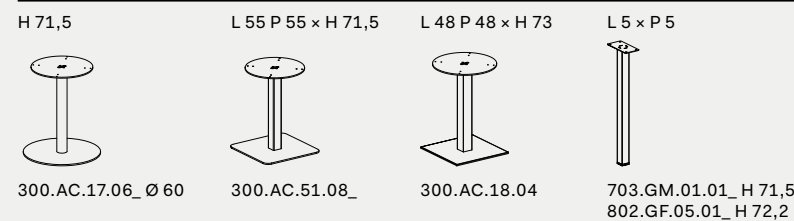

Tavoli su ruote con piano ribaltabile / Tables on castors with flip worktop

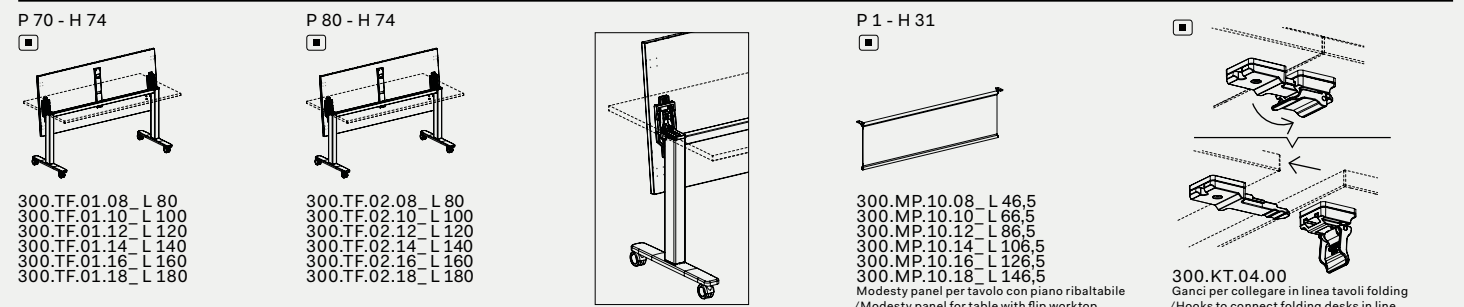

Morsetti e supporti in ABS per frontal panels Sp. 0,5 - 0,8 - 1 - 3 / ABS clamps for frontal panels T. 0,5 - 0,8 - 1 - 3 ^(A)

300.FP.27.00 Per piani/For worktops
300.FP.29.00 Per gamba (serie DV801 e DV802) /For leg (series DV801 and DV802)
300.FP.32.00 Per piano-gamba (serie DV801 e DV802)/For worktop-leg (series DV801 and DV802)
300.FP.30.00 Per gamba (serie DV805) /For leg (serie DV805)
300.FP.31.00 Per piano-gamba (serie DV805) /For worktop-leg (serie DV805)
300.FP.28.00 Per piani-binari /For worktops-track
300.FP.33.00 Free standing per piani /Free standing for worktops

Per frontal panels/For frontal panels ^(FP1) ^(FP6S) ^(FPP) ^(FP08) ^(FPC1) ^(FPC2)

Morsetti e supporti in ZAMA per frontal panels Sp. 0,5 - 0,8 - 1 - 3 / Zamak clamps for frontal panels T. 0,5 - 0,8 - 1 - 3 ^(Z)

300.FP.10.00 Per piani/For worktops
300.FP.20.00 Per gamba (serie DV801 e DV802) /For leg (series DV801 and DV802)
300.FP.21.00 Per piano-gamba (serie DV801 e DV802)/For worktop-leg (series DV801 and DV802)
300.FP.23.00 Per gamba (serie DV805) /For leg (serie DV805)
300.FP.24.00 Per piano-gamba (serie DV805) /For worktop-leg (serie DV805)
300.FP.22.00 Per piani-binari /For worktops-track
300.FP.33.00 Free standing per piani /Free standing for worktops
300.FP.26.00 Per FP 1; Per profilo attrezzabile (serie DV801)/For FP 1; For accessory profile (serie DV801)

Per frontal panels/For frontal panels ^(FP1) ^(FP6S) ^(FPP) ^(FP08) ^(FPC1) ^(FPC2)

Frontal panels H 65

P 1 x H 65 ^(A)
P 0,5 x H 65 ^(P)

300.FP.09.06_ L 64
300.FP.09.07_ L 79
300.FP.09.09_ L 99
300.FP.09.11_ L 119
300.FP.09.13_ L 139 ^(*)
300.FP.09.15_ L 159 ^(*)
300.FP.09.17_ L 179 ^(*)
300.FP.09.19_ L 199 ^(*)
Melaminico/Melamine

300.FP.69.06 L 64
300.FP.69.11 L 119
300.FP.69.13 L 139 ^(*)
300.FP.69.15 L 159 ^(*)
Plexiglass

Frontal panels H 65 con supporto freestanding integrato / Frontal panels with freestanding bracket integrated

L 77 P 18 x H 65 ^(A) L 77 P 18 x H 65 ^(Z) L 77 P 18 x H 65 ^(A) L 77 P 18 x H 65 ^(Z)

300.FR.20.07_ Melaminico / Melamine
300.FR.20.07_ Melaminico / Melamine
300.FR.21.07 Plexiglass
300.FR.21.07 Plexiglass

Frontal panels con supporti integrati / Frontal panels with clamps

L 77 P 1 x H 39 ^(A) L 77 P 1 x H 39 ^(Z)

300.FR.19.07_ Per piani melaminico /For worktops melamine
300.FR.19.07_ Per piani melaminico /For worktops melamine

Frontal panels Sp. 0,8 - 1

P 1 x H 39 P 0,8 x H 39 ^(V)

300.FP.06.06_ L 64
300.FP.06.07_ L 79
300.FP.06.09_ L 99
300.FP.06.11_ L 119
300.FP.06.13_ L 139
300.FP.06.15_ L 159
300.FP.06.17_ L 179
300.FP.06.19_ L 199
Melaminico/Melamine

300.FP.V1.06_ L 64
300.FP.V1.07_ L 79
300.FP.V1.09_ L 99
300.FP.V1.11_ L 119
300.FP.V1.13_ L 139
300.FP.V1.15_ L 159
300.FP.V1.17_ L 179
300.FP.V1.19_ L 199
Vetro/Glass

Frontal panel fonoassorbenti Sp. 3 / Acoustic frontal panels T. 3

P 3 x H 39 ^(*) P 3 x H 59 ^(*) P 3 x H 39 ^(*)

300.FP.40.06_ L 64
300.FP.40.07_ L 79
300.FP.40.09_ L 99
300.FP.40.11_ L 119
300.FP.40.13_ L 139
300.FP.40.15_ L 159
300.FP.40.17_ L 179
Tessuto/Fabric

300.FP.50.13_ L 139
300.FP.50.15_ L 159
Tessuto/Fabric

300.FP.45.13_ L 139
300.FP.45.15_ L 159
Frontal panel per profilo attrezzabile DV801 / Frontal panel for accessories profile DV801

Frontal panels con morsetti integrati / Frontal panels with clamps

P 4 x H 59 ^(*) ^(A) ^(Z)

300.FR.07.14_ L 140
300.FR.07.16_ L 160
Per piani/For worktops

^(*) In caso di BENCH, controllare lo spazio disponibile tra una gamba e l'altra/In the case of BENCH, verify the useful gap between a leg and the next one

Accessori per frontal panels in melaminico/Accessories for melamine frontal panels

L 6,5 P 6,5 x H 8,5 L 50 P 17 x H 3 L 31 P 22 x H 5 L 23 P 10 x H 29 L 35 P 6,5 x H 30

300.FA.01.01 300.FA.02.05 300.FA.04.03 300.FA.06.02 300.FA.08.03

^(*) Il posizionamento degli accessori sui frontal panel in vetro prevede l'utilizzo di una guarnizione in PVC trasparente (Optional su richiesta)/Placement of accessories on glass front panel need the use of a transparent PVC gasket (Optional on request)
Non utilizzabile su frontal panels in plexiglass e frontal panels in tessuto fonoassorbente / Not usable for plexiglass frontal panels and acoustic frontal panels

Note:

⁽¹⁾ Le dimensioni sono espresse in cm - consultare il listino prezzi per le caratteristiche tecniche, i codici degli articoli e delle finiture/Dimensions are stated in cm - for technical characteristics, article code numbers and finishing see price list;

^(*) Prodotti non in pronta consegna. Per la disponibilità contattare l'ufficio commerciale/Items not in prompt delivery. Please contact the commercial department to check availability;
^(A) Piani in Gres porcellanato/Worktops in Porcelain stoneware;
^(E) Fino ad esaurimento/Until exhaustion.

^(A) Morsetti o supporti in ABS /ABS clamps
^(Z) Morsetti o supporti in ZAMA / Zamak clamps
^(P) Plexiglass
^(V) Vetro/Glass.

Canalizzazione - Elettrificazione - Accessori/Wire management - Electrification - Accessories

300.AP.15.04 L 45
300.AP.15.05 L 58
300.AP.15.07 L 78
300.AP.15.08 L 88
300.AP.15.10 L 100
300.AP.15.11 L 110
300.AP.15.14 L 140
300.AP.15.16 L 160

300.AP.30.02 L 24
300.AP.30.06 L 60
300.AP.30.09 L 90
300.AP.30.11 L 110
300.AP.30.14 L 140
300.AP.30.16 L 160

300.CL.01.40 L 115

300.AP.20.00 L 57

804.CL.02.01 L 10
804.CL.02.04 L 45
804.CL.02.06 L 65
804.CL.02.08 L 85
804.CL.02.11 L 110

300.AP.U1.01 Ø 6
300.AP.U2.01 Ø 8
300.AP.U3.01 Ø 10,2

300.AP.T7.01_ Ø 6
300.AP.T8.01_ Ø 8

300.AP.F1.00 300.AP.08.00 300.AP.V1.00 300.AP.31.06 300.AP.V2.15 300.AC.33.02

L 24 P 10 x H 1,5

L 32 x P 12,3 P 17,5

300.AC.38.02_ H 2,4
300.AC.38.03_ H 3

300.AC.36.02_ H 1,8 ^(E)
300.AC.36.03_ H 2,5 ^(E)
300.AC.36.04_ H 3,8 ^(E)
300.AC.36.05_ H 5 ^(E)

300.AC.67.03 Marsupio per top access
300.AC.36_ _ 300.AC.38_ _ / Basket for top access
300.AC.36_ _ 300.AC.38_ _

300.AC.26.02_ L 24,5
300.AC.26.03_ L 34,5
300.AC.26.04_ L 44,5

300.AC.20.02_ L 24,5
300.AC.20.03_ L 34,5
300.AC.20.04_ L 44,5

300.AC.25.02 L 23,5
300.AC.25.03 L 33,5
300.AC.25.04 L 43,5
Marsupio/Basket

L 20,5 L 30 L 42 Ø 8

300.AP.S1.02 300.AP.S1.03 300.AP.S1.04
300.AP.S2.02 UK 300.AP.S2.03 UK 300.AP.S2.04 UK
300.AP.S3.02 US 300.AP.S3.03 US 300.AP.S3.04 US
Per top access 300.AC.26.02 /For top access 300.AC.26.02
Per top access 300.AC.26.03 /For top access 300.AC.26.03
Per top access 300.AC.26.04 /For top access 300.AC.26.04

300.AP.T8.11 300.AP.T8.12 - UK 300.AP.T8.13 - US
Tappo con 1 presa elettrica + USB (solo ricarica) + passacavo / Plug with 1 electrical socket + USB (only charge) + outlet lid

300.AP.T8.14 300.AP.T8.15 - UK 300.AP.T8.16 - US
Tappo con 1 presa elettrica + USB (solo ricarica) + HDMI / Plug with 1 electrical socket + USB (only charge) + HDMI

300.AP.T8.17 300.AP.T8.18 - UK 300.AP.T8.19 - US
Tappo con 1 presa elettrica + USB (solo ricarica) + RJ45 / Plug with 1 electrical socket + USB (only charge) + RJ45

300.AP.T8.20 300.AP.T8.21 - UK 300.AP.T8.22 - US
Tappo con 1 presa elettrica + USB (solo ricarica) + USB dati / Plug with 1 electrical socket + USB (only charge) + USB data

L 21 L 25,5 L 39 L 5 P 3 x H 5

300.AT.A6.02 300.AT.A6.03 300.AT.A6.04
300.AT.A7.02 UK 300.AT.A7.03 UK 300.AT.A7.04 UK
300.AT.A8.02 US 300.AT.A8.03 US 300.AT.A8.04 US

812.AC.08.01 812.AC.08.01 - UK
812.AC.08.01 - US
Presa USB (solo ricarica) / USB Socket (only charge)

300.AP.T4.01 300.AP.T5.01 UK 300.AP.T6.01 US ^(*)

300.AC.16.02_ 300.AC.06.05_

L 40 P 12 x H 10 L 7 P 7 x H 9

300.AB.08.04 Mensolina / Shelf
300.FA.09.01 Portapenna / Pen holder

Note:

⁽¹⁾ Le dimensioni sono espresse in cm - consultare il listino prezzi per le caratteristiche tecniche, i codici degli articoli e delle finiture/Dimensions are stated in cm - for technical characteristics, article code numbers and finishing see price list;

^(*) Prodotti non in pronta consegna. Per la disponibilità contattare l'ufficio commerciale/Items not in prompt delivery. Please contact the commercial department to check availability;

^(*) Articoli prodotti solo su richiesta /Items produced only on demand;
^(E) Fino ad esaurimento/Until exhaustion.

Bracci porta video/Arms for video support

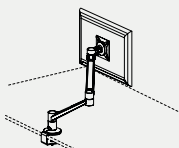
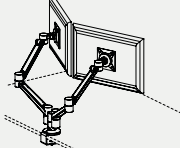
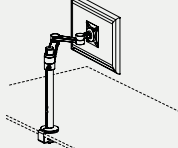
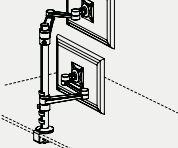
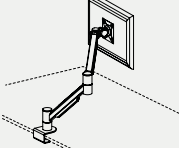
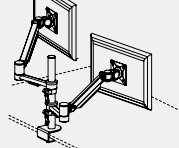
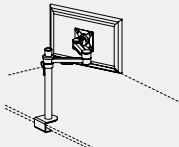
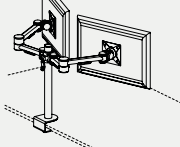
 300.AC.04.01 Braccio porta video mobile su piano /Dynamic arm for video support on deskbase	 300.AC.04.02 Doppio braccio porta video mobile su piano/2 dynamic arms for video support on deskbase	 300.AC.03.01 Braccio porta video statico su palo /Static arm for video support on pole	 300.AC.03.02 Doppio braccio porta video statico su palo/2 static arms for video support on pole	 300.AC.02.01 Braccio porta video mobile su piano /Dynamic arm for video support on deskbase	 300.AC.02.02 Doppio braccio porta video mobile su piano/2 dynamic arms for video support on deskbase
 300.AC.01.01 Braccio porta video statico su palo/Static arm for video support on pole	 300.AC.01.02 Doppio braccio porta video statico su palo/2 static arms for video support on pole				

Pensile / Overhead unit

L 78 P 35 x H 42

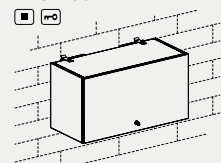

300.AC.75.07_

Mensola con supporti/Wall-shelf with supports

P 30 x H 2,5

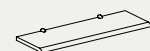

300.AC.M1.09_L 90
300.AC.M1.13_L 130
300.AC.M1.18_L 180

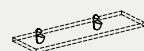

300.AC.M2.00
Coppia ovetti reggi-mensola / Pair of egg-shaped wall-shelf support

Contenitori multiuso/Multipurpose units

L 80 P 40 x H 40

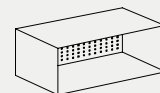

300.AC.15.08
Contenitore porta dox in lamiera / Steel top box

L 35 P 24 x H 35



300.AC.14.03_
Box multiuso / Storage box

Divani/Sofas

L 84 P 80 x H 83



300.AC.D1.08

L 144 P 80 x H 83

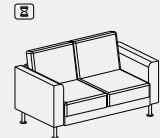

300.AC.D1.14

Note:

1 Le dimensioni sono espresse in cm - consultare il listino prezzi per le caratteristiche tecniche, i codici degli articoli e delle finiture/Dimensions are stated in cm - for technical characteristics, article code numbers and finishing see price list;

2 Prodotti non in pronta consegna. Per la disponibilità contattare l'ufficio commerciale/Items not in prompt delivery. Please contact the commercial department to check availability;

3 Con serratura

DVO S.R.L. con unico socio
Via XX Settembre, 272
Casella Postale n. 65
U.P. Roveredo in Piano
33080 Roveredo in Piano (PN)
Italy

Tel. +39 0434 386 111
Fax +39 0434 386 112
www.dvo.it
info@dvo.it

Art Director
Enzo Berti

Photo
Tobia Berti

Rendering
Nudesignstudio
Lone Studio

Stylist
Mara Zambon

Issue 01
March 2021

Foto e testi copyright
DVO non riproducibili.
La venditrice si riserva
la facoltà di apportare
al prodotto eventuali
modifiche tecniche,
dimensionali ed estetiche
in qualsiasi momento
senza preavviso.

Pictures and text are
DVO copyright, duplicate
forbidden. The selling
Company reserves the
right to introduce changes
to products regarding
sizes and aesthetical
or technical aspects at
any timewithout notice.



DVO S.R.L. - AZIENDA CERTIFICATA / CERTIFIED COMPANY



Richiedi i prodotti certificati FSC® / Request for FSC® certified products

Il marchio della
gestione forestale
responsabile

dvo_

DVO S.R.L. con unico socio
Via XX Settembre, 272
Casella Postale n. 65
U.P. Roveredo in Piano
33080 Roveredo in Piano (PN)
Italy

Tel. +39 0434 386 111
Fax +39 0434 386 112
www.dvo.it
info@dvo.it