

- 1 - VETRO TRASPARENTE
TRANSPARENT GLASS - VERRE TRASPARENT
- 2 - VETRO LACCATO NO-PRINT
LACQUERED NO-PRINT GLASS - VERRE LAQUÉ NO -PRINT
- 3 - VETRO LACCATO
LACQUERED GLASS - VERRE LAQUÉ
- 4 - RIVESTITO IN PELLE
LEATHER COVER - COUVERTURE EN CUIR
- 5 - LACCATO OPACO ANTIGRAFFIO
SCRATCH RESISTANT MATT LACQUERED - LAQUÉ MAT ANTI-RAYURE
- 6 - IMPIALLACCIATO
WOOD VENEER - PLAQUÉ
- 7 - ESSENZA MELAMINICO
MFC TYPES - MÉLAMINÉ
- 8 - GIUNTO IN PRESSOFUSIONE DI ALLUMINIO
JOINTS IN DIE-CAST ALUMINIUM
LIAISON EN ALUMINIUM MOULÉ SOUS PRESSION
- 9 - GAMBA IN ESTRUSO DI ALLUMINIO
EXTRUDED ALUMINIUM LEG - PIÈTEMENT EN EXTRUDÉ ALUMINIUM
- 10 - PIEDINO DI REGOLAZIONE CROMATO
CHROMED LEVELLING FOOT - PATINS DE NIVELLEMENT CHROMÉS
- 11 - TRAVE INTUBOLARE DI ACCIAIO
TUBULAR STEEL BEAM - POUTRE ENTUBULAIRE D'ACIER

**Piani di lavoro in ESSENZA MELAMINICO**

Realizzati con pannelli sp.18mm, rivestiti con carta melaminica classe E1 su due lati, con bordi perimetrali in ABS sp.2mm arrotondati. I piani sono disponibili in 8 finiture, 4 standard e 4 on demand.

Piani di lavoro IMPIALLACCIATI

Realizzati con pannelli sp.19mm, rivestiti con impiallacciatura precomposta con bordi perimetrali arrotondati, disponibile in 4 tinte (2 chiare e 2 scure). Verniciatura con finitura poro aperto.

Piani di lavoro in LACCATO OPACO

Realizzati con pannelli sp.18mm, laccati opachi comprensivi di trattamento antigraffio sul lato superiore del piano. I piani sono disponibili in 14 colori YOGA e laccato RAL.

Piani di lavoro rivestiti in PELLE

Realizzati con pannelli sp.18mm, rivestiti in pelle. Il rivestimento comprende anche tutti i bordi e termina sotto il piano. Cuciture in tinta. I piani rivestiti sono disponibili in 6 colori di Pelle. Pelle bovina mezzo fiore a grana naturale di spessore finito 0,9 – 1,1 mm. Concia al cromo. Tintura passante. Articolo con mano morbida, tatto ceroso e aspetto semiopaco.

Piani di lavoro in VETRO LACCATO

Realizzati in vetro temperato sp.10mm. Il lato superiore è lucido mentre il lato inferiore dei vetri è verniciato a freddo. I piani sono disponibili in 9 colori YOGA e laccato RAL.

Piani di lavoro in VETRO LACCATO NO-PRINT

Realizzati in vetro temperato sp.10mm. Il lato superiore ha un trattamento di satinatura NO-PRINT che elimina "l'effetto impronta", mentre il lato inferiore dei vetri è verniciato a freddo. I piani sono disponibili in 9 colori YOGA e laccato RAL.

Piani di lavoro in VETRO TRASPARENTE

Realizzati in vetro temperato sp.10mm. I piani comprendono tondini in acciaio inox per il fissaggio alla struttura. I piani sono disponibili in 3 differenti finiture e permettono la visibilità delle strutture.

MFC Worktops

Made of panels th.18mm, class E1 melamine faced on two sides, with perimetric rounded ABS edges th.2mm. Worktops are available in 8 different finishes (4 standard and 4 on demand).

WOOD VENEER Worktops

Made of panels th.19mm, faced with precomposed wood veneer with perimetric rounded edges, available in 4 different finishes (2 bright and 2 dark versions). Surface painting with open pore finish.

MATT LACQUERED Worktops

Made of panels th.18mm, matt lacquered with protective treatment (anti scratch) on upper side of worktop. Worktops are available in 14 different YOGA colours or RAL lacquered.

LEATHER COVERED Worktops

Made of panels th.18mm, leather upholstered. The coating also includes all the edges and ends under the worktop. Matching stitches. Covered tops are available in 6 colors of leather. Bovine of European origin, lightly buffed natural grain, finished thickness 0.9 – 1.1 mm. Chrome tannage. Through dyed. Article with a pigmented and protective coat, with a soft, waxy feel and semi-matt appearance.

LACQUERED GLASS Worktops

Made of toughened glass th.10mm. The upper side is polished while the underside of the glass is cold coated. Worktops are available in 9 different YOGA colours or RAL lacquered.

LACQUERED NO-PRINT GLASS Worktops

Made of toughened glass th.10mm. The upper side has a NO-PRINT satin finish which avoids «fingerprint effect», while the underside of the glass is cold coated. Worktops are available in 9 different YOGA colours or RAL lacquered.

TRANSPARENT GLASS Worktops

Made of toughened glass th.10mm. Worktops are supplied with spacers made of stainless steel for connection to structure. Worktops are available in 3 different finishes and allow visibility of structures..

Plans de travail en MÉLAMINÉ

Réalisés avec panneaux de 18 mm d'ép. Revêtus en papier mélaminé de classe E1 sur les deux cotés, chants en ABS ép. 2mm arrondis. Les plateaux sont disponibles en 8 finitions, 4 standard et 4 sur demande.

Plans de travail PLAQUÉS

Réalisés avec panneaux de 19 mm d'ép. Revêtus en placage d'ingénierie avec chants arrondis. Disponible en 4 finitions, 2 claire et 2 foncée. Verni en finition à pore ouvert.

Plans de travail LAQUÉS MAT

Réalisés avec panneaux de 18 mm d'ép, laqués mat et avec traitement anti rayure dessus. Les plateaux sont disponibles en 14 couleurs YOGA et laqués RAL.

Plans de travail avec COUVERTURE EN CUIR

Réalisés avec panneaux de 18 mm d'ép., cuir revêtus. Le revêtement comprend aussi tous les bords et se termine sous le plan de travail. Points correspondants. Sommets couverts sont disponibles en 6 coloris de cuir. Vachette rectifié ou corrigé et grains naturels d'origine Européenne. Epaisseur: 0,9 – 1,1 mm. Teint dans la masse. Cet article de haute qualité a une main très souple sur toute la superfi cie et un touché ciré. Aspect: semi-opaque.

Plans de travail en VERRE LAQUE

Réalisés en verre trempé de 10 mm d'ép. Le dessus du verre est poli, le dessous est verni à froid. Les plateaux sont disponibles en 9 couleurs YOGA et laqués RAL.

Plans de travail en VERRE LAQUÉ NO-PRINT

Réalisés en verre trempé de 10 mm d'ép. Le dessus est imprimé en sérigraphie NO-PRINT avec système "anti trace", le dessous est verni à froid. Les plateaux sont disponibles en 9 couleurs YOGA et laqués RAL.

Plans de travail en VERRE TRANSPARENT

Réalisés en verre trempé de 10 mm d'ép. Les plateaux ont des petits éléments en acier inox pour es fixer à la structure. Les plateaux sont disponibles en 3 finitions et toutes permettent de voir à travers.



PIANI IN ESSENZA MELAMINICO ED IMPIALLACCIATI

WORKTOPS IN MFC TYPES OR WOOD VENEER _ PLATEAUX EN MÉLAMINÉ ET PLAQUÉS

■ ESSENZE MELAMINICHE STANDARD MELAMINE STANDARD TYPES . ESSENCES MELAMINE STANDARD



N3BD Bianco Dance
White Dance . Blanc Dance



N2WE Wengè
Wenge . Wenge



N3RT Rovere Twist
Durmast Twist . Chêne Twist



N3OC Olmo Classic
Elm Classic . Orme Classique

■ ESSENZE MELAMINICHE ON DEMAND MELAMINE ON DEMAND TYPES . ESSENCES MELAMINE ON DEMAND



N3LG Larice Glam
Larch Glam . Mélèze Glam



N3NS Noce Soul
Walnut Soul . Noyer Soul



N3CB Ciliegio Blues
Cherry Blues . Cerise Blues



N3RF Rovere Funk
Durmast Funk . Chêne Funk

■ IMPALLACCIATI WOOD VENEER PLAQUÉS



i1NC Noce chiaro
Light Walnut . Noyer Clair



i1NS Noce scuro
Dark Walnut . Noyer Sombre



i1RO Rovere
Durmast . Chene



i1WE Wengè
Wengè . Wengè



PIANI IN ESSENZA MELAMINICO ED IMPIALLACCIATI

WORKTOPS IN MFC TYPES OR WOOD VENEER _ PLATEAUX EN MÉLAMINÉ ET PLAQUÉS





PIANI LACCATI ANTIGRAFFIO

WORKTOPS SCRATCH RESISTANT LACQUERED _ PLATEAUX LAQUÉS ANTI-RAYURE

■ LACCATI OPACHI MATT LACQUERED LAQUÉES MATES

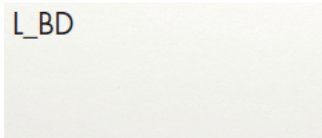

L_BD

L_BD Bianco Dance
White Dance . Blanc Dance



L_GY

L_GY Grigio Yoga
Grey Yoga . Gris Yoga



L_CR

L_CR Cipria Rosata
Rosy Face Powder
Poudre Rose



L_SD

L_SD Sabbia Desertica
Desert Sand . Sable Du Désert



L_VA

L_VA Verde Acido
Acid Green . Vert Acide



L_TS

L_TS Tortora Selvatica
Wild Dove
Tourterelle Sauvage



L_AB

L_AB Arancione Brillante
Bright Orange . Orange Brillant

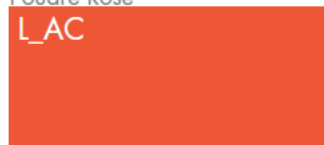

L_AC

L_AC Aragosta Cotta
Steamed Lobster
Langouste Cuite



L_RC

L_RC Rosso Cardinale
Cardenal Red . Rouge Cardinal

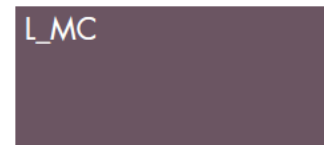

L_MC

L_MC Melanzana Cruda
Raw Aubergine
Aubergine Crue



L_BV

L_BV Blu Vivo
Sparkling Blue . Bleu Vif



L_CL

L_CL Cioccolato al latte
Milk Chocolate
Chocolat au Lait



L_GS

L_GS Grigio Scuro
Dark Grey . Gris Sombre



L_NY

L_NY Nero Yoga
Black Yoga . Noir Yoga



L_RL

L_RL Ral
Ral . Ral



PIANI LACCATI ANTIGRAFFIO

WORKTOPS SCRATCH RESISTANT LACQUERED _ PLATEAUX LAQUÉS ANTI-RAYURE





PIANI RIVESTITI IN PELLE

WORKTOPS LEATHER COVER _ PLATEAUX AVEC COUVERTURE EN CUIR

■ RIVESTIMENTI PELLE LEATHER COVER COUVERTURE EN CUIR



P1BG
P1BG Beige
Beige . Beige



P1AT
P1AT Asfalto
Asphalt . Asphalte



P1BN
P1BN Blu Notte
Blue Night . Bleu Nuit



P1MS
P1MS Marsala
Marsala . Marsala



P1CG
P1CG Castagna
Chestnut . Châtaigne



P1NE
P1NE Nero
Black . Noir





SCHEMA CUCITURE PIANI IN PELLE

LEATHER STITCHING PATTERN PLANS - PLANS DE MOTIF DE COUTURE EN CUIR

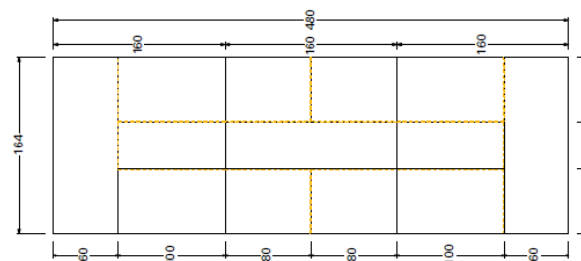
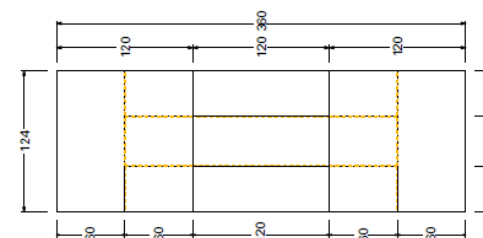
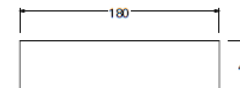
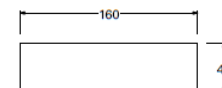
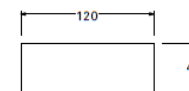
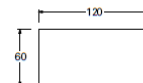
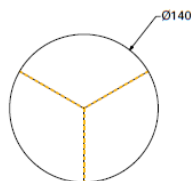
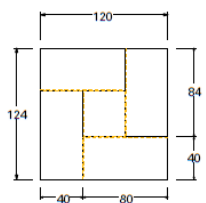
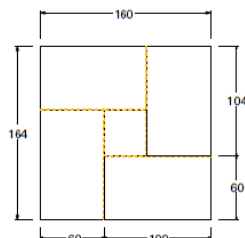
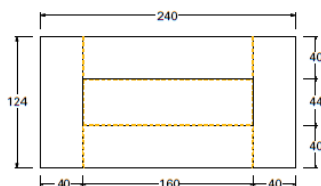
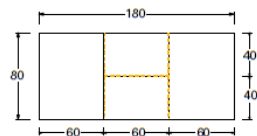
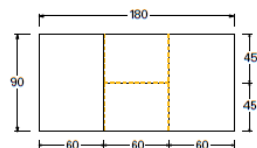
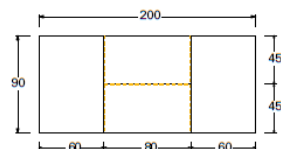
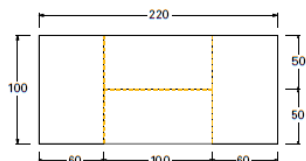



PIANI RIVESTITI IN PELLE

WORKTOPS LEATHER COVER _ PLATEAUX AVEC COUVERTURE EN CUIR





PIANI VETRO LACCATO

WORKTOPS IN LACQUERED GLASS _ PLATEAUX EN VERRE LAQUÉ

VETRI LACCATI LACQUERED GLASSES VERRES LAQUEES

E1BD



E1BD Bianco Dance
White Dance . Blanc Dance

E1GY



E1GY Grigio Yoga
Grey Yoga . Gris Yoga

E1GF



E1GF Grigio Fango
Mud Grey . Gris Boue

E1CT



E1CT Cappuccino
Cappuccino . Cappuccino

E1VA



E1VA Verde Acido
Acid Green . Vert Acide

E1MS



E1MS Marsala
Marsala . Marsala

E1BV



E1BV Blu Vivo
Sparkling Blue . Blue Vif

E1MK



E1MK Moka
Moka . Moka

E1NY



E1NY Nero Yoga
Black Yoga . Noir Yoga

E1RL



E1RL Ral
Ral . Ral

VETRI LACCATI NO-PRINT NO-PRINT LACQUERED GLASSES VERRES LAQUEES NO-PRINT

E3BD



E3BD Bianco Dance
White Dance . Blanc Dance

E3GY



E3GY Grigio Yoga
Grey Yoga . Gris Yoga

E3GF



E3GF Grigio Fango
Mud Grey . Gris Boue

E3CT



E3CT Cappuccino
Cappuccino . Cappuccino

E3VA



E3VA Verde Acido
Acid Green . Vert Acide

E3MS



E3MS Marsala
Marsala . Marsala

E3BV



E3BV Blu Vivo
Sparkling Blue . Blue Vif

E3MK



E3MK Moka
Moka . Moka

E3NY



E3NY Nero Yoga
Black Yoga . Noir Yoga

E3RL



E3RL Ral
Ral . Ral



PIANI VETRO LACCATO

WORKTOPS IN LACQUERED GLASS _ PLATEAUX EN VERRE LAQUÉ





PIANI VETRO TRASPARENTE

WORKTOPS IN CLEAR GLASS _ PLATEAUX EN VERRE TRANSPARENTES

■ VETRI TRASPARENTI CLEAR GLASS VERRES TRANSPARENTES

E1EC



E1EC Extrachiaro
Extra light . Extra clair

E3VS



E3VS Satinato NO-PRINT
NO-PRINT Satinated
Satiné NO-PRINT

V1GE



V1GE Grigio Europeo
European Grey . Gris Européen





PIANI VETRO TRASPARENTE

WORKTOPS IN CLEAR GLASS _ PLATEAUX EN VERRE TRANSPARENTES



E1EC



V1GE





GAMBE - GIUNTI - TRAVI

LEGS - JOINTS - BEAMS _ PIÈTEMENTS - LIAISON - POUTRE

Gambe e giunti scrivania

Gambe realizzate in estruso di alluminio a sezione trapezoidale 54x35mm sp.3mm con piedino di livellamento in finitura cromata.

Giunto in pressofusione di alluminio.

Gamba e giunto sono verniciati e disponibili in 3 finiture superficiali: finitura goffrato, laccato e cromato.

Travi

Travi realizzate in tubolare di acciaio sezione quadrata 40x40mm sp.2mm. Le travi per i piani coprenti sono standard in finitura A2GY. Mentre per i piani trasparenti la trave segue il colore della gamba e del giunto.

Carter centrale tavolo riunioni

Struttura interna in tubolare di acciaio sezione interna 40x40mm sp.2mm, carter esterno in lamiera di acciaio microforata sp.1mm e con piedino di livellamento in finitura cromata. Il carter comprende un tappo passacavi cromato che consente l'uscita dei cavi di elettrificazione. Disponibile in 3 finiture superficiali: finitura goffrato, laccato e cromato.

Legs and joints of desk

Legs made of extruded aluminium profile with trapezoidal section 54x35mm th.3mm with levelling foot in chrome finish

Joints in die-cast aluminium.

Legs and joints are painted and available in 3 different surface finishes: textured finish, lacquered or chromed.

Beams

Beams made of steel tube with square section 40x40mm th.2mm. The beams for blind worktops are with standard finish A2GY. The beam for transparent worktops follows colour of leg and joint.

Central vertical panel for meeting tables

Internal structure made of steel tube with square section 40x40mm th.2mm, cover made of micro perforated steel plate th.1mm. Comes with chrome finished levelling feet and chrome finished cable outlet for vertical cable management.

Available in 3 different surface finishes: texture finish, lacquered or chromed.

Piètements et liaisons du bureau

Piètement réalisé en extrusion d'aluminium à section trapézoïdal 54x35mm ép. 3 mm avec patins de nivellement en finition chromée. Liaison en aluminium réalisées en moulage sous pression.

Piètement et liaisons sont vernis et sont disponibles en 3 finitions spéciales: gaufrés, laqués et chromés.

Poutres

Réalisées en tubulaire en acier à section carrée 40x40mm ép. 2mm. Les poutres pour le plateau non-transparents sont avec la finition standard A2GY. La poutre pour les plans transparents suit le couleur du piètement et de la liaison.

Carter centrale des tables de réunion

Structure interne en tubulaire d'acier avec section interne 40x40mm ép. 2mm, carter externe en acier micro-perforé ép. 1mm et avec patin de nivellement en finition chromé. Le carter inclue un bouchon passe-câbles chromé pour la sortie de câbles pour électrification.

Disponibile en 3 finitions spéciales: gaufré, laqué et chromé.



GAMBE - GIUNTI - TRAVI

LEGS - JOINTS - BEAMS _ PIÉTEMENTS - LIAISON - POUTRE

■ ALLUMINIO FINITURA GOFFRATA ALUMINIUM TEXTURED FINISHING ALUMINIUM FINITION GAUFFRÉ



A1BD Bianco Dance
White Dance . Blanc Dance



A1GY Grigio Yoga
Grey Yoga . Gris Yoga



A1NY Nero Yoga
Black Yoga . Noir Yoga

■ ALLUMINIO FINITURA LACCATA ALUMINIUM LACQUERED FINISHING ALUMINIUM FINITION LAQUÉS



A2BD Bianco Dance
White Dance . Blanc Dance



A2GY Grigio Yoga
Grey Yoga . Gris Yoga



A2NY Nero Yoga
Black Yoga . Noir Yoga



A2RL Ral
Ral . Ral

■ ALLUMINIO FINITURA LUCIDA ALUMINIUM LUCID FINISHING ALUMINIUM FINITION POLI



A1CF Cromo Funky
Chrome Funky . Chrome Funky



GAMBE - GIUNTI - TRAVI

LEGS - JOINTS - BEAMS _ PIÉTEMENTS - LIAISON - POUTRE

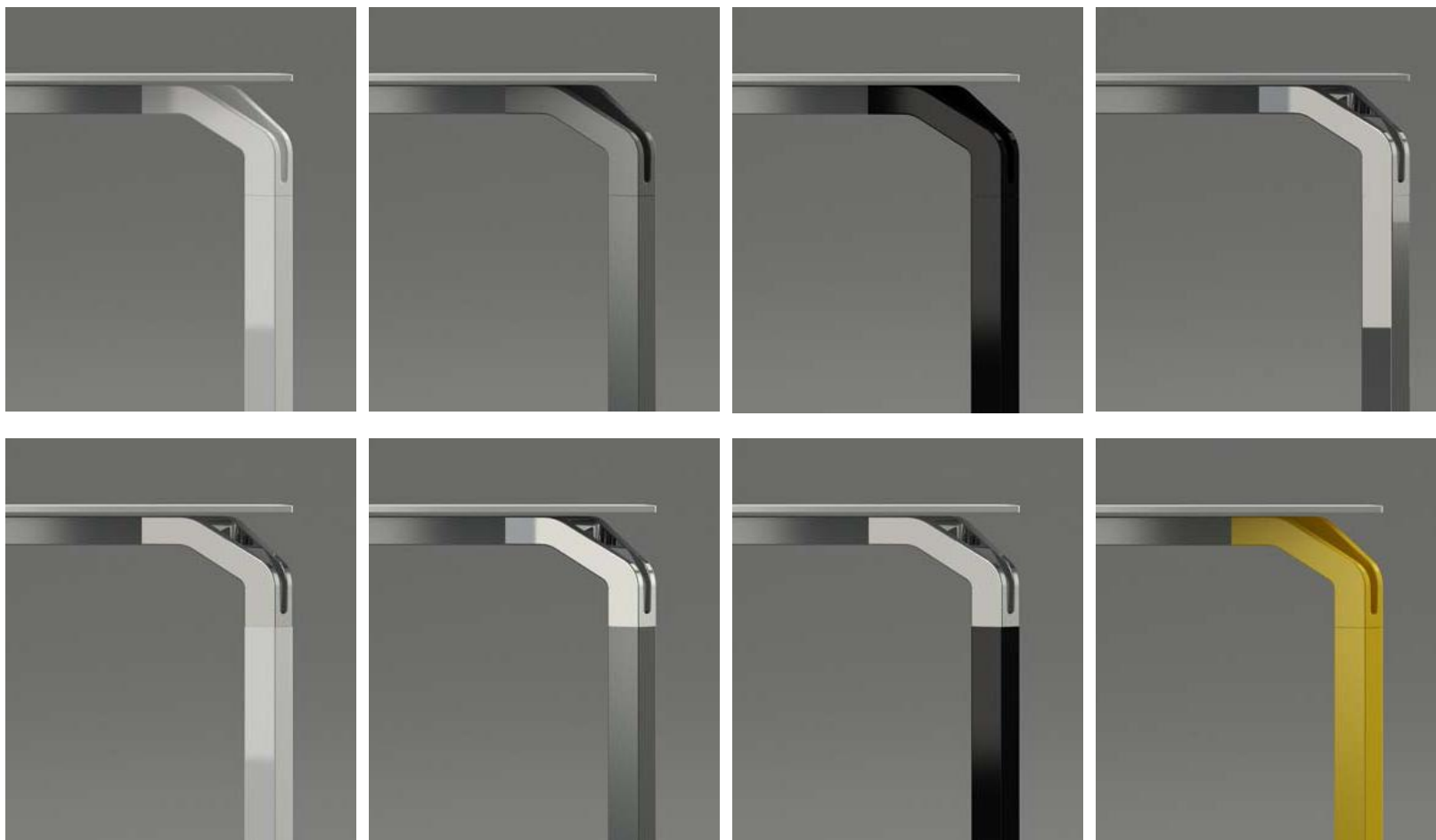



GAMBE - GIUNTI - TRAVI

LEGS - JOINTS - BEAMS _ PIÉTEMENTS - LIAISON - POUTRE





MOBILI STRUTTURALI PER SCRIVANIE O INDIPENDENTI

INDEPENDENT OR DESK STRUCTURAL CONTAINERS - RANGEMENT INDÉPENDANTE OU DE SOUTIEN AUX BUREAUX





MOBILI STRUTTURALI PER SCRIVANIE O INDIPENDENTI

INDEPENDENT OR DESK STRUCTURAL CONTAINERS - RANGEMENT INDÉPENDANTE OU DE SOUTIEN AUX BUREAUX

Struttura

Realizzata con pannelli sp.18mm, rivestiti con carta melaminica classe E1 su due lati, con bordi perimetrali in ABS sp.1mm arrotondati.

Piedini di livellamento H.45mm in ABS.

Disponibili in 2 finiture melaminico, 14 laccati opaco YOGA e laccato RAL. Possibilità di inserire zoccolo a telaio nelle finiture melaminico delle strutture o cromo.

Top e fianchi di finitura

Realizzata con pannelli sp.18mm, rivestiti con carta melaminica classe E1 su due lati, con bordi perimetrali in ABS sp.2mm arrotondati.

Disponibili in 9 finiture essenza melaminico, 4 impiallacciati, 14 laccati opaco YOGA e laccato RAL.

Ante scorrevoli

Sistema di scorrimento su doppio binario, con meccanismo di rallentamento di chiusura.

Le ante scorrevoli possono essere in 6 versioni: essenza melaminico classe E1, impiallacciato, laccati opaco YOGA, laccati RAL, vetro telaio alluminio 20/45 con maniglia incorporata nel telaio, vetro NO-PRINT su supporto melaminico.

Cassetti

Cassetti su guide in metallo ad estrazione totale con chiusura ammortizzata e serratura centralizzata.

I frontali possono essere in 6 versioni: essenza melaminico classe E1, impiallacciato, laccati opaco YOGA, laccati RAL, vetro telaio alluminio 20/45 con maniglia incorporata nel telaio, vetro NO-PRINT su supporto melaminico.

Structure

Made of panels th.18mm, class E1 melamine faced on two sides, with perimetric rounded ABS edges th.1mm. ABS levelling feet H.45mm.

Available in 2 MFC finishes, 14 different matt lacquered YOGA finishes or RAL lacquered. Optional plynth frame with MFC finishes of structure or chromed.

Finishing top and sides

Made of panels th.18mm, class E1 melamine faced on two sides, with perimetric rounded ABS edges th.2mm. Available in 9 MFC finishes, 4 wood veneer finishes, 14 different matt lacquered YOGA finishes or RAL lacquered.

Sliding doors

Sliding system on double track, with slow motion closing mechanism.

The sliding doors can be in 6 different versions: class E1 melamine faced, veneered, matt lacquered YOGA, lacquered RAL, glass aluminum framed 20/45 with a built in frame handle, glass NO-PRINT on MFC panel.

Drawers

Drawers on metal runners for full extension, with soft motion closing and central locking. The drawer fronts are available in 6 different versions: class E1 melamine faced, veneered, matt lacquered YOGA, lacquered RAL, glass aluminum framed 20/45 with a built in frame handle, glass NO-PRINT on MFC panel.

Structure

Réalisés avec panneaux de 18 mm d'ép. Revêtus en papier mélaminé de classe E1 sur les deux côtés, chants en ABS ép. 1mm arrondis. Patins de nivellement H45 mm en ABS. Disponible en 2 finitions mélaminées, 14 laquées mat YOGA et laquée RAL. Possibilité d'ajouter un socle avec les finitions mélaminées ou chromées.

Tops et panneaux de finition

Réalisés avec panneaux de 18 mm d'ép. Revêtus en papier mélaminé de classe E1 sur les deux côtés, chants en ABS ép. 2mm arrondis.

Disponibles en 9 finitions mélaminées, 4 plaquées 14 laquées mat YOGA et laquées RAL.

Portes coulissantes

Système de glissement sur double binaire, avec mécanisme de fermeture douce.

Les portes coulissantes peuvent être en 6 versions: mélaminé classe E1, plaqué, laqué mat YOGA, laqué RAL, verre avec cadre alu 20/45 avec poignée intégrées aux cadre, verre NO-PRINT sur support mélaminé.

Tiroirs

Tiroirs sur guides en métal à ouverture totale, avec fermeture douce et serrure centralisée. Les façades peuvent être en 6 versions: mélaminé classe E1, plaqué, laqué mat YOGA, laqué RAL, verre avec cadre alu 20/45 avec poignées intégrées aux cadre, verre NO-PRINT sur support mélaminé.



CONFIGURAZIONE SCRIVANIE CON MOBILI STRUTTURALI

CONFIGURATION OF DESKS WITH STRUCTURAL CONTAINERS - BUREAUX EN CONFIGURATION AVEC RANGEMENT DE SOUTIEN

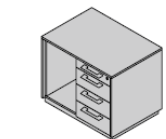
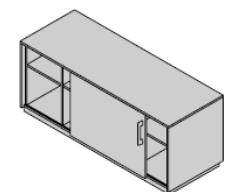
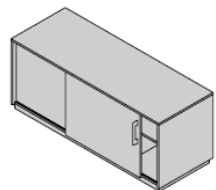
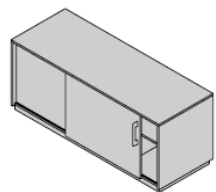

L 220 P 100

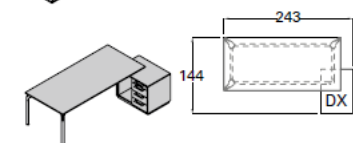
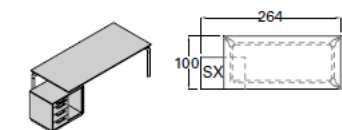
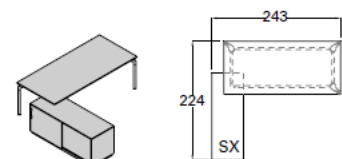
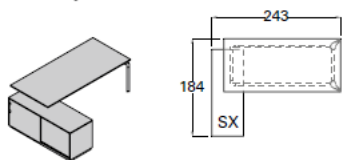
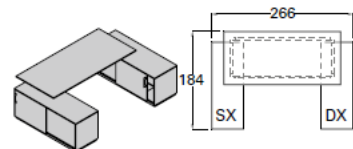
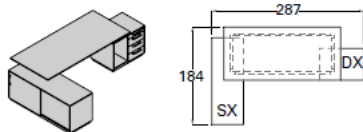

L 200 P 90

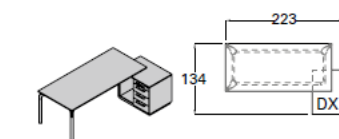
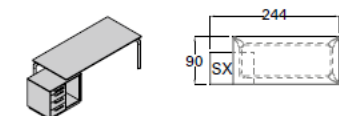
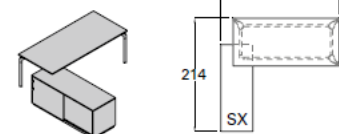
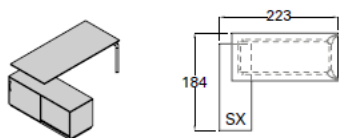

L 180 P 90

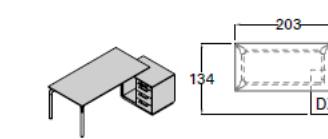
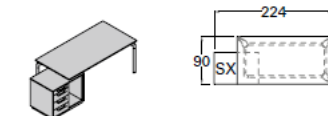
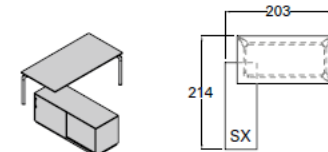
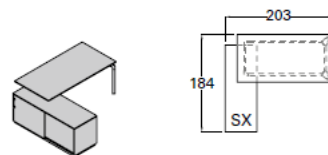

L 160 P 164

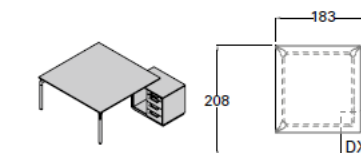
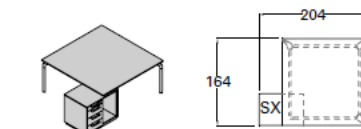
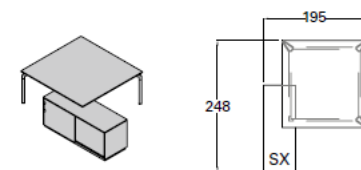
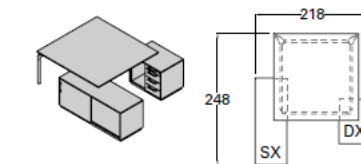
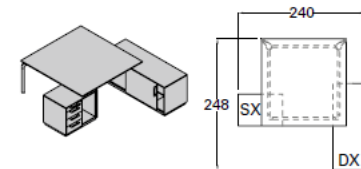



CASSETTIERE E MOBILI DI SERVIZIO

PEDESTALS AND SERVICE UNITS _ CAISSONS ET MEUBLES DE RANGEMENT



**CASSETTIERE E MOBILI DI SERVIZIO****PEDESTALS AND SERVICE UNITS _ CAISSONS ET MEUBLES DE RANGEMENT****Mobili di Servizio**

Realizzati con pannelli sp.18mm rivestiti con carta melaminica classe E1 su due lati bordati in ABS 1mm. Struttura disponibile in 2 finiture melaminico, 14 laccati opaco YOGA e laccati RAL. Frontali disponibili in 5 finiture essenza melaminico classe E1, 4 impiallacciati, 14 laccati opaco YOGA e laccati RAL. Cassetti ad estrazione totale e chiusura ammortizzata e serratura centralizzata. Top, fianchi e schienale di finitura disponibili in 5 finiture melaminico, 14 finiture laccato opaco YOGA e laccato RAL, oppure realizzati in vetro temperato sp.10mm disponibili in 9 colori YOGA e laccati RAL. Possibilità di inserire zoccolo in finitura cromo.

Cassettiere in melaminico

Realizzate con pannelli sp.18mm rivestita con carta melaminica su due lati in classe E1, bordati completamente con ABS 2mm. Ruote piroettanti con freno. Cassetti a scorrimento su guide in metallo con serratura centralizzata. Disponibili in 9 finiture essenza melaminico, 14 laccato opaco YOGA e laccato RAL. Disponibili ruote cromate e cassetti ammortizzati.

Cassettiere impiallacciate

Realizzate con pannelli sp.19mm, rivestiti con impiallacciatura precomposta con bordi arrotondati disponibile in 4 diverse tinte (2 chiare e 2 scure).

Ruote piroettanti con freno. Cassetti a scorrimento su guide in metallo con serratura centralizzata. Disponibili on demand ruote cromate e cassetti ammortizzati.

Cassettiere in metallo

Realizzate con lamiera d'acciaio 8/10 verniciata a caldo con polveri epossidiche, ruote piroettanti, cassetti a scorrimento su guide in metallo, sistema anti ribaltamento, chiusura centralizzata. Disponibili in 3 finiture YOGA e laccati RAL. Tra le finiture è disponibile una finitura in acciaio inox lucidato e spazzolato.

Service Units

Made of panels th.18mm, class E1 melamine faced on two sides, with perimeteric rounded ABS edges th.1mm. Structure available in 2 MFC finishes, 14 different matt lacquered YOGA finishes or RAL lacquered. Fronts available in 5 MFC finishes category E1, 4 wood veneer finishes, 14 different matt lacquered YOGA finishes or RAL lacquered. Drawers with full extension, with soft motion closing and central locking. Finishing top, sides and rear panel available in 5 MFC finishes, 14 different matt lacquered YOGA finishes or RAL lacquered, ore made of toughened glass th.10mm available in 9 different YOGA colours or RAL lacquered (on demand). Optional chromed plynth frame.

MFC Pedestals

Made of panels th.18mm, class E1 melamine faced on two sides, all with ABS edges th.2mm. Pivoting castors with brakes. Drawers sliding o metal runners with central drawer locking. Available in 9 different MFC finishes, 14 different matt lacquered YOGA finishes or RAL lacquered. Optional chromed castors and soft motion closing mechanism for drawers.

WOOD VENEER Pedestals

Made of panels th.19mm, faced with precomposed wood veneer with perimeteric rounded edges, available in 4 different finishes (2 bright and 2 dark versions) Pivoting castors with brakes. Drawers sliding on metal runners with central drawer locking. Optional chromed castors and soft motion closing mechanism for drawers.

METAL Pedestals

Made of steel plate 8/10 hot epoxy powder painted, pivoting castors, drawers sliding on metal runners, anti tilt mechanism, central drawer locking. Available in 3 YOGA finishes or RAL lacquered. Also available in stainless steel polished and brushed.

Meubles de rangement

Réalisés avec panneaux de 18 mm d'ép. Revêtus en papier mélaminé de classe E1 sur les deux cotés, chants en ABS ép. 1mm Structure disponible en 2 finitions melaminées, 14 laquées mat YOGA et laquée RAL. Facades disponibles en 5 finitions melaminées classe E1, 4 plaquées, 14 lacquées mat YOGA et laquées RAL. Tiroirs à ouverture totale, avec fermeture douce et serrure centralisée. Top, panneaux et dos de finition disponibles en 5 finitions melaminées, 14 finitions laquées mat YOGA et laqué RAL, ou ils sont disponibles en verre trempé ép. 10 mm disponible en 9 couleurs YOGA et laqué RAL. Possibilité d'ajouter un socle chromé.

Caissons en mélaminé

Réalisés avec panneaux de 18 mm d'ép., revêtus en papier mélaminé de classe E1 sur les deux cotés, chants en ABS ép. 2mm Roulettes pivotantes avec frein. Tiroirs sur guide en metal avec serrure centralisée Disponible en 9 finitions melaminées, 14 laquées mat YOGA e laqué RAL. Disponibles, sur demande, des roulettes chromées et des tiroirs avec fermeture douce.

Caissons plaqués

Réalisés avec panneaux de 19 mm d'ép., revêtus en bois d'ingénierie et avec chant arrondis. Disponible en 4 teintes (2 claire et 2 foncées). Roulettes pivotantes avec frein. Tiroirs sur guide en métal avec serrure centralisée Disponibles, sur demande, des roulettes chromées et des tiroirs avec fermeture douce.

Caissons en métal

Réalisés en tôle d'acier 8/10 vernie à chaud aux poudres époxy, roulettes pivotantes, tiroirs sur guides en métal, système anti basculement, fermeture centralisée. Disponibles en 3 finitions YOGA et laqués RAL. Disponibles, il y a une finition en acier inoxydable



LIBRERIA IN ALLUMINIO

MODULAR OPEN STRUCTURE IN ALUMINIUM _ BIBLIOTHÈQUE MODULAIRE EN ALU





LIBRERIA IN ALLUMINIO

MODULAR OPEN STRUCTURE IN ALUMINIUM _ BIBLIOTHÈQUE MODULAIRE EN ALU

Libreria modulare a giorno con struttura in alluminio

Struttura con montanti in profilo quadrato di alluminio 25/25mm, disponibile in ossidato argento lucido o verniciato in 2 finiture. Piedino di livellamento in alluminio inserito alla base del montante. Ripiani melaminico disponibili in 2 finiture essenza melaminico classe E1, 14 colori laccati opaco YOGA e laccati RAL.

Ripiani in vetro su supporto in melaminico laccati con profilo in alluminio sui lati longitudinali. Disponibili in 9 colori YOGA e laccati RAL.

Moduli pensili sospesi a giorno con struttura in alluminio

Struttura con montanti in profilo quadrato di alluminio 25/25mm, disponibile in ossidato argento lucido o verniciato in 2 finiture. Sistema di aggancio a parete con regolazione per pareti in muratura (non si fornisce ferramenta per altri supporti es. cartongesso).

Ripiani melaminico disponibili in 2 finiture essenza melaminico classe E1, 14 colori laccati opaco YOGA e laccati RAL. Ripiani in vetro su supporto in melaminico classe E1 laccato con profilo in alluminio sui lati longitudinali. Disponibili in 9 colori YOGA e laccati RAL.

Modular open bookcase with aluminium structure

Structure with aluminium mounts with square section 25/25mm, available or glossy silver oxidized or painted in 2 different finishes. Levelling foot in aluminium inserted at the base of the upright. Shelves available in 2 MFC finishes, class E1, 14 different matt lacquered YOGA finishes or RAL lacquered. Glass shelves on lacquered MFC support with aluminium profile on longitudinal sides. Available in 9 different lacquered YOGA finishes or RAL lacquered.

Wall fixed modular open units with aluminium structure

Structure with aluminium mounts with square section 25/25mm, available or glossy silver oxidized or painted in 2 different finishes. Wall fixing system with tuning for solid walls (no supply of hardware for other walls - i.e. gypsum walls) Shelves available in 2 MFC finishes, class E1, 14 different matt lacquered YOGA finishes or RAL lacquered. Glass shelves on lacquered class E1 MFC support with aluminium profile on longitudinal sides. Available in 9 different lacquered YOGA finishes or RAL lacquered.

Bibliothèque modulaire ouverte avec structure en aluminium

Structure avec montant au profil carré en aluminium 25/25mm, disponible en argent brillant oxydé ou verni en 2 finitions. Patin de nivellement en alu inséré à la base du montant. Étagères disponibles en 2 finitions mélaminées classe E1, 14 couleurs laqués mat YOGA et laqué RAL. Étagères en verre sur support mélaminé, laqués, avec profil alu sur cotés longitudinaux. Disponibles en 9 couleurs YOGA et laqué RAL.

Éléments de rangement suspendus, avec structure en alu

Structure avec montant au profil carré en aluminium 25/25mm, disponible en argent brillant oxydé ou verni en 2 finitions. Système d'accrochage à la cloison avec nivellement pour murs durs (pas de quincaillerie est prévue pour d'autres supports p.ex., placoplatre). Étagères disponibles en 2 finitions en mélaminé classe E1, 14 couleurs laqués mat YOGA et laquées RAL. Étagères en verre sur support mélaminé, laqués, avec profil alu sur cotés longitudinaux. Disponibles en 9 couleurs YOGA et laqués RAL.



LIBRERIE IN LEGNO LACCATO

BOOKCASES IN LACQUERED MFC _ BIBLIOTHÈQUES LAQUÉS



**LIBRERIE IN LEGNO LACCATO****BOOKCASES IN LACQUERED MFC _ BIBLIOTHÈQUES LAQUÉS****Libreria componibile H.167**

Struttura e ripiani realizzati con pannelli sp.30mm rivestiti con carta melaminica classe E1 su due lati bordati con ABS sp.2mm, schienali interni sp.12mm bordati con bordi parapolvere. Piedini di livellamento con regolazione. Struttura disponibile in 14 colori laccati opaco YOGA e laccati RAL.

Le ante possono essere in 4 versioni: 14 colori laccati opaco YOGA, laccati RAL, vetro trasparente con telaio alluminio 20/20, vetro NO-PRINT su supporto melaminico. Cerniere con apertura 110°. Sistema di apertura e chiusura PUSH&PULL. Senza serratura.

Modular bookcase H.167

Structure and shelves made of panels th.30mm, class E1 melamine faced on both sides with perimetric rounded ABS edges th.2mm, internal rear panel th.12mm with soft edge. Levelling feet with adjustment.

Structure available in 14 different matt lacquered YOGA finishes or RAL lacquered. Doors available in 4 different versions: 14 different matt lacquered YOGA finishes, RAL lacquered, aluminium framed 20/20 transparent glass, NOPRINT glass on MFC support. 110° opening hinges. PUSH&PULL opening and closing system. No lock.

Bibliothèque modulable H.167

Structure et étagères réalisées avec panneaux de 18 mm d'ép., revêtus en papier mélaminé de classe E1 sur les deux côtés, chants en ABS ép. 2mm, dos internes ép. 12mm avec chant et chants anti-poussières. Patins de nivellement réglables.

Structure disponible en 14 couleur laqués mat YOGA et laqués RAL. Les portes peuvent être en 4 versions : 14 couleurs laqués mat YOGA, laqué RAL, verre transparent avec cadre 20/20, verre NO-PRINT sur support mélaminé. Charnières avec ouverture à 110°. Système d'ouverture et fermeture PUSH&PULL. No serrure.



CONTENITORI SOSPESI A MURO

WALL FIXED CONTAINERS _ ELÉMENTS DE RANGEMENT SUSPENDUS



**CONTENITORI SOSPESI A MURO****WALL FIXED CONTAINERS _ ELÉMENTS DE RANGEMENT SUSPENDUS****Struttura basi e pensili**

Realizzata con pannelli sp.18mm, rivestiti con carta melaminica classe E1 su due lati, con bordi perimetrali in ABS sp.1mm arrotondati. Sistema di aggancio con attaccaglie regolabili sia frontale che verticale per pareti in muratura (non si fornisce ferramenta per supporti es. cartongesso). Disponibili in 2 finiture essenza melaminico, 14 laccati opaco YOGA e laccati RAL.

Frontali basi sospese

Le basi sospese possono essere con anta a ribalta con cerniere incassate e meccanismo frizionato regolabile, oppure con cassettoni estraibile su guide ammortizzate ad estrazione totale. Entrambe con sistema di apertura e chiusura PUSH&PULL. I frontali sono disponibili in 7 versioni: essenza melaminico classe E1, impiallacciato, laccati opaco YOGA, laccati RAL, vetro con telaio alluminio 20/45, vetro trasparente con telaio alluminio 20/20, vetro NO-PRINT su supporto melaminico.

Frontali pensili sospesi

I pensili sospesi possono essere con anta a ribalta o vasistas con cerniere incassate e meccanismo frizionato regolabile. Entrambe con sistema di apertura e chiusura PUSH&PULL. I frontali sono disponibili in 7 versioni: essenza melaminico classe E1, impiallacciato, laccati opaco YOGA, laccati RAL, vetro con telaio alluminio 20/45, vetro trasparente con telaio alluminio 20/20, vetro NO-PRINT su supporto melaminico. Per un corretto funzionamento si consiglia di montare il modulo vasistas ad una distanza minima da terra di 140 cm.

Mensole a muro

Realizzate con pannelli sp.25mm rivestita con carta melaminica classe E1 su due lati bordati con ABS sp.2mm. Reggimensola regolabile a scomparsa inserito nello spessore delle mensole per pareti in muratura (non si fornisce ferramenta per altri supporti es. cartongesso).

Structure base elements and upper elements

Made of panels th.18mm, class E1 melamine faced on two sides, with perimetric rounded ABS edges th.1mm. Wall fixing and adjustment with brackets with frontal and vertical tuning for solid walls (no supply of hardware for other walls - i.e. gypsum walls). Available in 2 different MFC finishes, 14 different matt lacquered YOGA finishes or RAL lacquered.

Fronts of base elements

Wall fixed bases available with flap door with recessed hinges and adjustable friction mechanism, or with drawers with full extraction and slow motion mechanism. Both with PUSH&PULL opening and closing system. Fronts available in 7 different versions: Class E1 MFC finish, wood veneer, matt YOGA lacquered, RAL lacquered, aluminium framed 20/45 glass, aluminium framed 20/20 transparent glass, NO-PRINT glass on MFC support.

Fronts of upper elements

Wall fixed upper elements are available with flap or bottom hinged door with recessed hinges and adjustable friction mechanism. Both with PUSH&PULL opening and closing system. Fronts available in 7 different versions: Class E1 MFC finish, wood veneer, matt YOGA lacquered, RAL lacquered, aluminium framed 20/45 glass, aluminium framed 20/20 transparent glass, NO-PRINT glass on MFC support. For proper operation it is recommended to mount the bottom hinged door elements at least 140cm from ground.

Wall fixed shelves

Made of panels th.25mm, class E1 melamine faced on two sides, with perimetric ABS edges th.2mm. Adjustable fixing bracket recessed in thickness of shelf. For solid walls (no supply of hardware for other walls - i.e. gypsum walls).

Structure bases et éléments de rangement suspendus

Réalisée avec panneaux de 18 mm d'ép., revêtus en papier mélaminé de classe E1 sur les deux côtés, chants en ABS ép. 1mm arrondis. Système d'accrochage avec nivellement frontal et vertical pour murs durs (pas de quincaillerie est prévue pour d'autres supports p.ex., placoplatre). Disponible en 2 finitions mélaminées, 14 laqués mat YOGA et laqué RAL.

Façades des bases de rangement suspendus

Les bases suspendues peuvent être avec porte abattante avec charnières encaissées et mécanisme frotté réglable, ou avec tiroir extractible coulissant, fermeture douce, ouverture totale. Les deux solutions sont avec système d'ouverture et fermeture PUSH&PULL. Les façades sont disponibles en 7 versions: mélaminé, plaqué, laqué mat YOGA, laqué RAL, verre avec cadre alu 20/45, verre transparent avec cadre alu 20/20, verre NO-PRINT support mélaminé.

Façades des éléments de rangement suspendus

Les éléments suspendus peuvent être avec porte abattante ou Vasistas avec charnières encaissées et fermeture douce. Les deux solutions sont avec système d'ouverture et fermeture PUSH&PULL. Les façades sont disponibles en 7 versions: mélaminé classe E1, plaqué, laqué mat YOGA, laqué RAL, verre avec cadre alu 20/45, verre transparent avec cadre alu 20/20, verre NO-PRINT sur support mélaminé. Pour un fonctionnement idéal nous suggérons de fixer le module Vasistas à la distance de min. 140 cm. du sol.

Etagères à mur

Réalisées avec panneaux de 25 mm d'ép., revêtus en papier mélaminé de classe E1 sur les deux côtés, chants en ABS ép. 2mm. Soutiens réglables, pas visibles, insérés dans l'épaisseur de l'étagère même pour murs durs. (Pas de quincaillerie est prévue pour d'autres supports p.ex., placoplatre).



MOBILI CONTENITORI
STORAGE UNITS_ARMOIRES

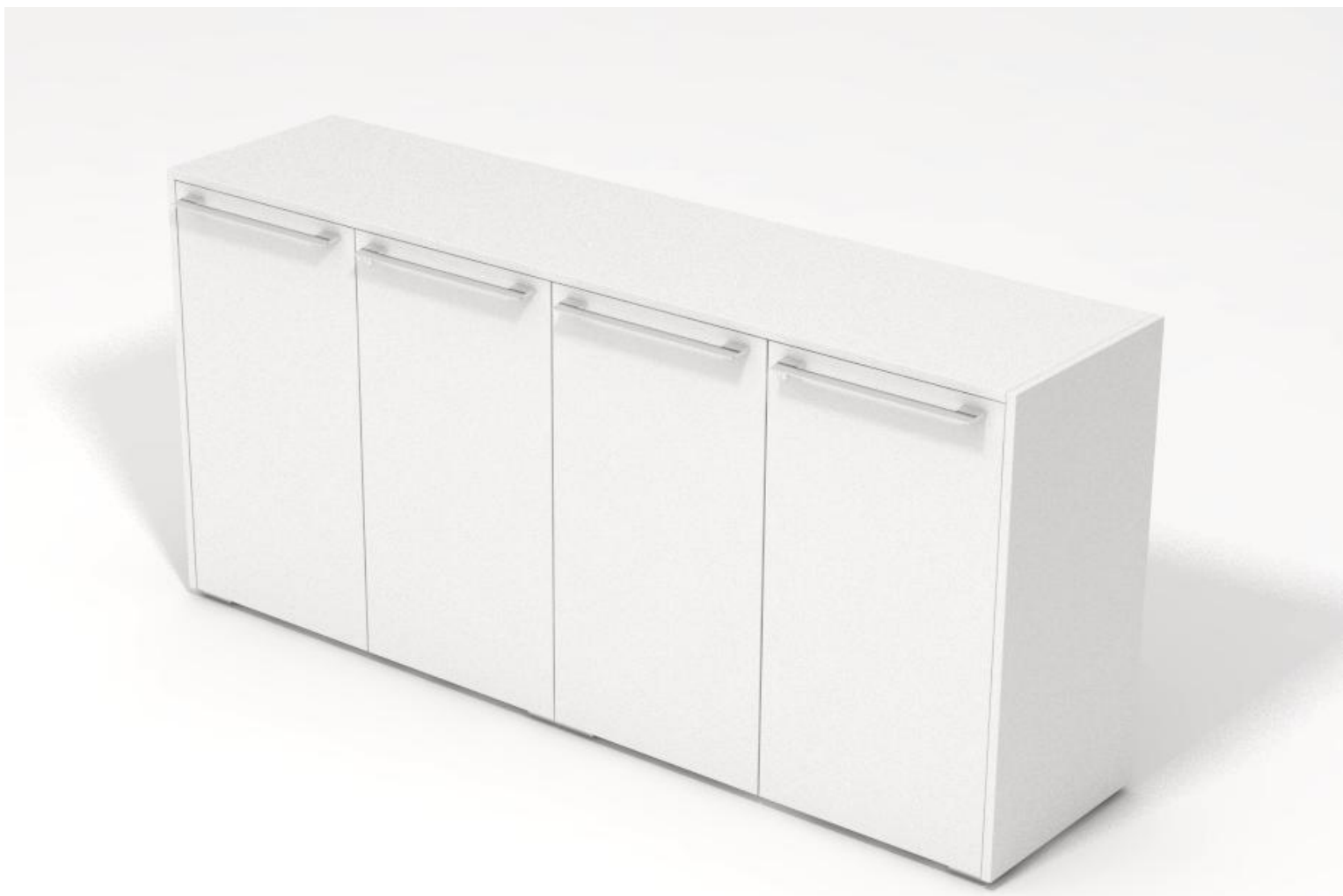



MOBILI CONTENITORI STORAGE UNITS_ ARMOIRES

Struttura

Realizzata con pannelli sp.18mm, rivestiti con carta melaminica classe E1 su due lati, con bordi perimetrali in ABS sp.1mm arrotondati. Ripiani 25mm.

Piedini di livellamento con regolazione dall'interno struttura.

Disponibili in 3 finiture essenza melaminico classe E1, 14 laccati opaco YOGA e laccati RAL.

Ante

Dotate di cerniere regolabili e serratura di serie su tutte le ante (escluso vetro NO-PRINT).

I frontali sono disponibili in 7 versioni: essenza melaminico classe E1 sp.18mm, impiallacciato sp.19mm, laccati opaco YOGA sp.18mm, laccati RAL, vetro con telaio alluminio 20/45, vetro con telaio alluminio 20/20, vetro NO-PRINT su supporto melaminico.

Maniglie

Maniglia a scelta per ante in essenza melaminico, impiallacciate, laccati YOGA e laccati RAL.

Maniglia in alluminio incorporata nel telaio per ante vetro con telaio 20/45 e telaio 20/20.

Su ante vetro NO-PRINT di serie sistema di apertura e chiusura PUSH&PULL.

Top e fianchi di finitura

Realizzata con pannelli sp.18mm, rivestiti con carta melaminica classe E1 su due lati, con bordi perimetrali in ABS sp.2mm arrotondati.

Disponibili in 9 finiture essenza melaminico, 4 impiallacciati, 14 laccati opaco YOGA e laccati RAL.

Structure

Made of panels th.18mm, class E1 melamine faced on two sides, with perimetric rounded ABS edges th.1mm. Shelves th. 25mm.

Levelling feet with adjustment from internal of structure.

Available in 3 different class E1 MFC finishes, 14 different matt lacquered YOGA finishes or RAL lacquered.

Doors

All doors with adjustable hinges and lock (no locks on NO-PRINT glass doors).

Fronts available in 7 different versions: Class E1 MFC finish th.18mm, wood veneer th.19mm, matt YOGA lacquered th.18mm, RAL lacquered, aluminium framed 20/45 glass, aluminium framed 20/20 glass, NO-PRINT glass on MFC support.

Handles

Selection of different handles available for MFC doors, wood veneer doors, YOGA or RAL lacquered doors. Handle integrated in aluminium frame for glass door with frame 20/45 or frame 20/20.

NO-PRINT glass doors are all provided with PUSH&PULL opening and closing system.

Finishing tops and sides

Made of panels th.18mm, class E1 melamine faced on two sides, with perimetric rounded ABS edges th.2mm.

Available in 9 different MFC finishes, 4 wood veneer finishes, 14 different matt lacquered YOGA finishes or RAL lacquered.

Structure

Réalisée avec panneaux de 18 mm d'ép., revêtus en papier mélaminé de classe E1 sur les deux côtés, chants en ABS ép. 1mm arrondis. Etagères en ép. 25mm.

Patins de nivellement avec réglage de l'intérieur de la structure.

Disponible en 3 finitions mélaminées classe E1, 14 laquées mat YOGA et laquée RAL.

Portes

Pourvues de charnières réglables et serrure sur toutes les portes (verre NO-PRINT exclus).

Les façades sont disponibles en 7 versions: mélaminé classe E1 sp.18mm, plaqué ép.19mm, laqué mat YOGA ép. 18mm, laqué RAL, verre avec cadre alu 20/45, verre transparent avec cadre alu 20/20, verre NO-PRINT sur support mélaminé.

Poignées

Poignées à choix pour portes en mélaminé, plaquées laquées YOGA et laquées RAL. Poignée en alu intégrée au cadre pour portes en verre avec cadre 20/45 et cadre 20/20.

Sur le portes en verre NO-PRINT ouverture et fermeture sont par le système PUSH&PULL.

Tops et panneaux de finition

Réalisés avec panneaux de 18 mm d'ép. Revêtus en papier mélaminé de classe E1 sur les deux côtés, chants en ABS ép. 2mm arrondis.

Disponibles en 9 finitions mélaminées, 4 plaqués, 14 laqués mat YOGA e laqué RAL.



TIPOLOGIE ANTE VETRO – TYPES GLASS DOORS - PORTES TYPES DE VERRE

Telaio Alluminio 20/45
Aluminium frame 20/45
Cadre alu 20/45

A2BD, A2NY, A2AL

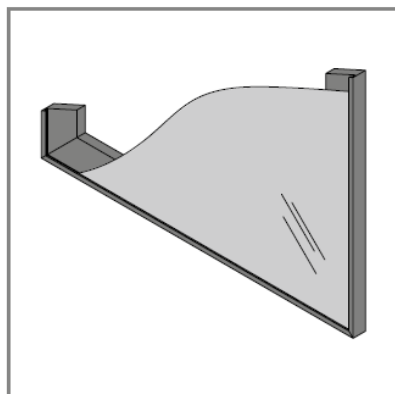

Vetro
Glass
Verre

**E1BD, E1GY, E1GF, E1CT, E1VA,
E1MS, E1BV, E1MK, E1NY, E1RL,
V1GE, V1SL**

Telaio Alluminio 20/20
Aluminium frame 20/20
Cadre alu 20/20

A2BD, A2NY

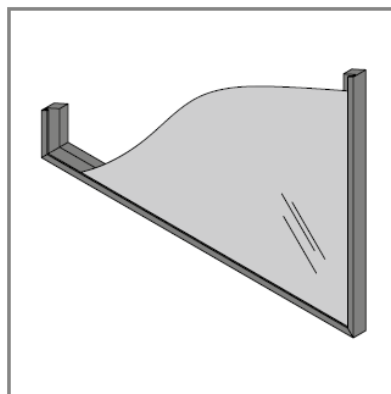

Vetro
Glass
Verre

**E1BD, E1GY, E1GF, E1CT, E1VA,
E1MS, E1BV, E1MK, E1NY, E1RL,
V1GE, V1SL**

Telaio Alluminio 20/20
Aluminium frame 20/20
Cadre alu 20/20

A2BD, A2NY

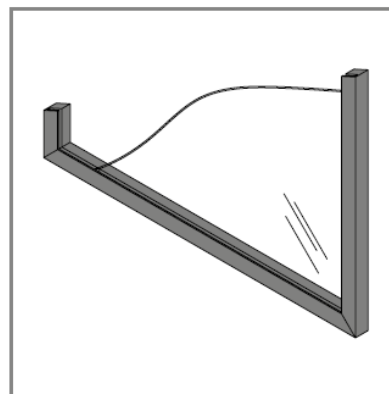

Vetro Trasparente
Transparent glass
Verre transparent

E1EC

Supporto melaminico
MFC support panel
Panneau soutien en mélamine

N3BD, N3NJ, L1RL

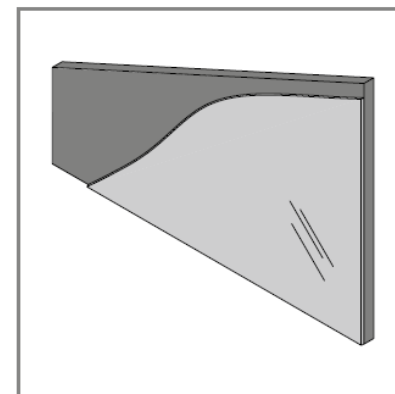

Vetro NO - PRINT
NO-PRINT Glass
Verre NO-PRINT

**E3BD, E3GY, E3GF, E3CT, E3VA,
E3MS, E3BV, E3MK, E3NY, E3RL**



MANIGLIE HANDLES - POIGNÉES

Interasse 320mm
Measurement 320mm
Mesure 320mm



D912

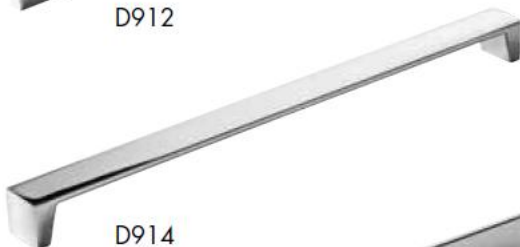

D914

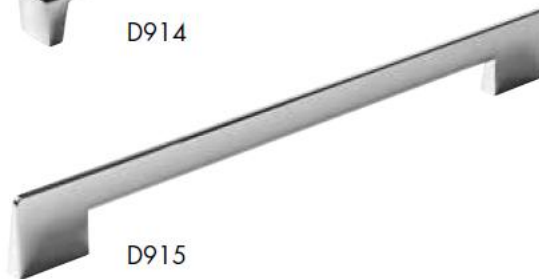

D915

Interasse 160mm
Measurement 160mm
Mesure 160mm



D902



D904



D905



POSIZIONAMENTO GONNA FRONTALE

POSITIONING MODESTY PANEL - PLACEMENT VDF

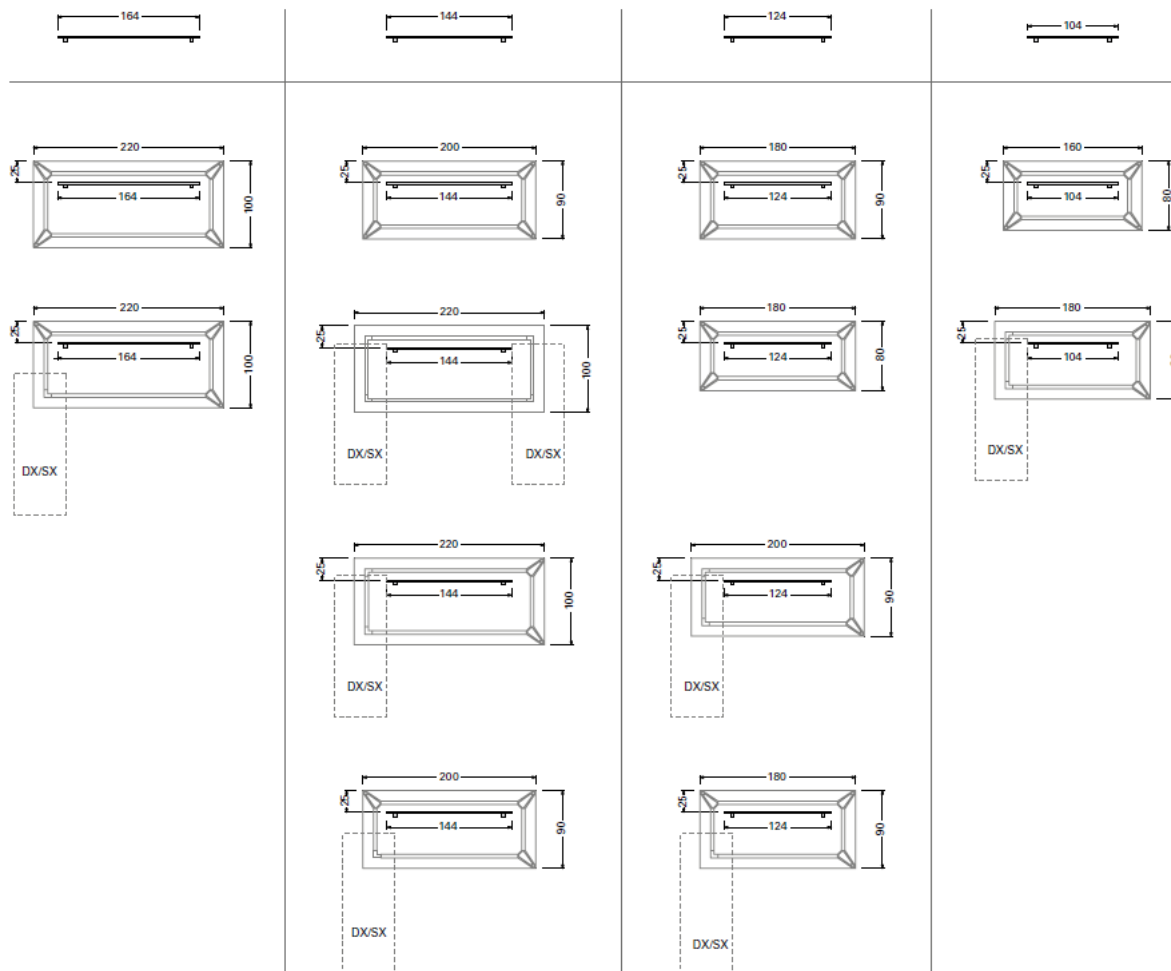



ELETTIFICAZIONE SCRIVANIE CABLE MANAGEMENT - ELECTRIFICATION

Esempi Examples Exemple

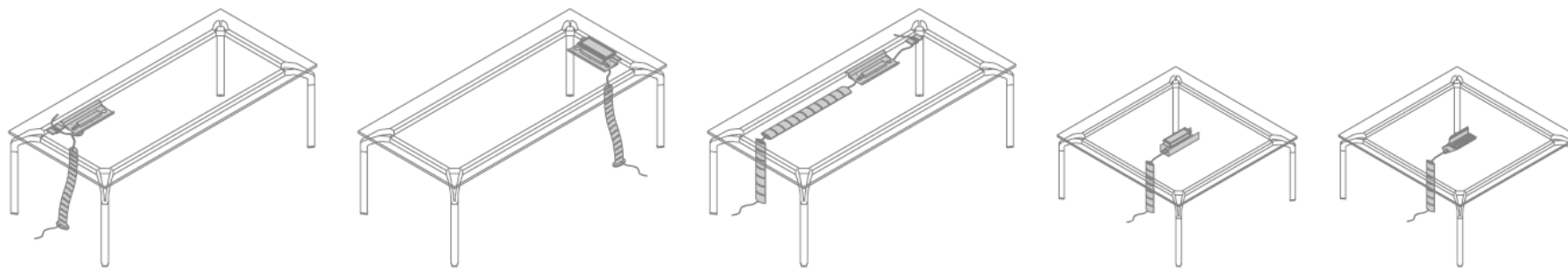

Ø 6

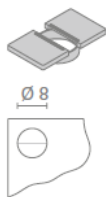

Ø 8

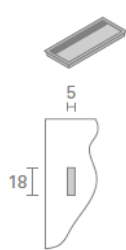

5

18

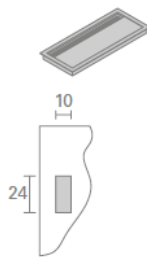

10

24

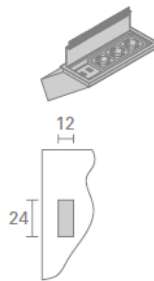

12

24

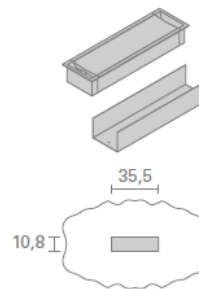

35,5

10,8

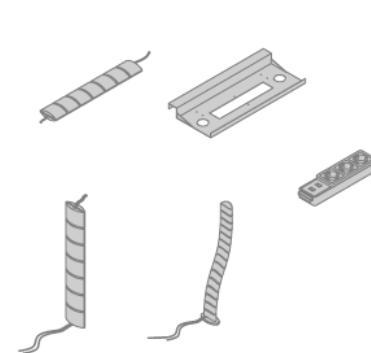



ELETTTRIFICAZIONE SCRIVANIE
CABLE MANAGEMENT - ELECTRIFICATION





finiture "STANDARD"

prodotti con finiture "standard" in melaminico, metallo e alluminio, sono disponibili a magazzino come prodotto finito per consegna veloce.

"STANDARD" finishes

Products with "standard" finishes in melamine, metal and aluminium, are available as finished product from stock for fast delivery.

finitions "STANDARD"

Produits avec finitions "standard" en melaminé, en metal ou en Aluminium, ils sont disponible au dépôt comme produit fini pour une livraison rapide.

finiture "ON DEMAND"

Prodotti con finiture "on demand": vengono realizzati su commessa. I tempi di consegna variano in base alla tipologia di finitura on demand, quindi vengono comunicati separatamente.

finishes "ON DEMAND"

Products with finishes "on demand": they are produced on demand. Delivery times vary depending from the type of finish on demand and are confirmed accordingly.

finitions "ON DEMAND"

Produits avec finitions "on demand": réalisés sur demande. Les temps de livraison changent en relation à la typologie des finitions et sont communiqués séparément.

Spiegazione composizione codice articolo:

i codici articoli dei prodotti about office sono composti dai seguenti elementi:

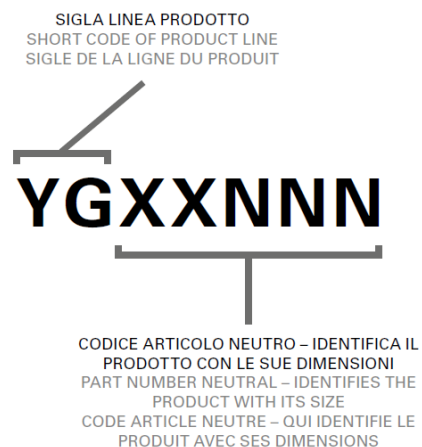

Explanation configuration article code:

about office article codes consist of the following elements:

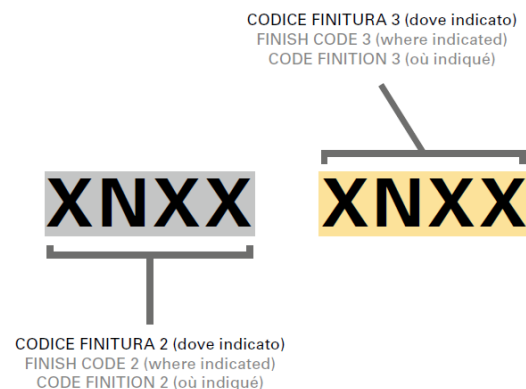
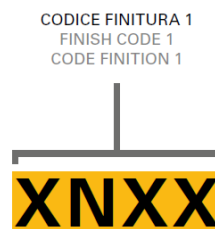

Explication composition du code article:

les codes articles des produits about office sont composés par les éléments suivantes:

