

DV800 Workstations

DV401 E-Media

dvo_

dvo_

**DV800 Workstations
DV401 E-Media**

Cod.	Pag.
DV806 Baku 	004
DV804 E-Place	016
DV801 Entity	048
DV802	102
DV803 Nobu	158
DV807 4S	198
DV805 Treko	210
DV812 Enna (New)	242
DV816 Nida (New)	272

Workstations

DV806 Baku



Design:
dvo_

IT Semplicità ed essenzialità con un design incisivo e riconoscibile, rendono questa linea operativa giovane e simpatica facilmente adattabile in qualsiasi spazio di lavoro.

EN The expression of simplicity and essentiality combined with a sharp and recognizable design, make this operative series a fresh and alternative solution, adaptable to every work environment.







Tavoli/Tables

Piani di lavoro sp. 1.8 cm, in melaminico con bordi in ABS sp. 0.2 cm / Worktops 1.8 cm thick, in melamine with ABS edge-profiles 0.2 cm thick

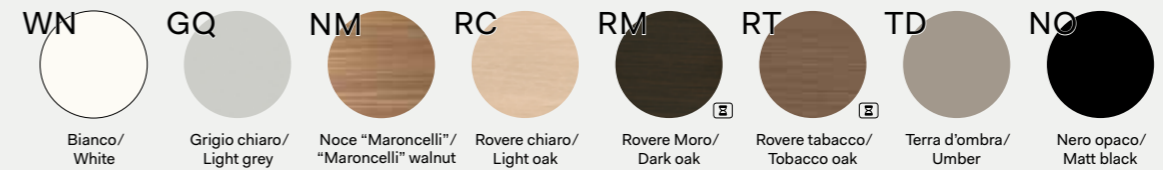

Piani di lavoro sp. 1 cm, in vetro temprato retrolaccato acidato con bordi perimetrali lavorati a filo lucido / Worktops 1 cm thick, rear-lacquered and acetated tempered glass with outer polished edges



Strutture metalliche/Metal structures

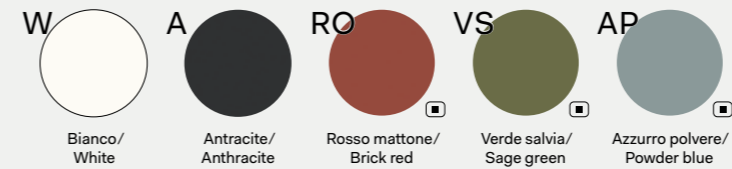

Modesty panel

Modesty panel sp. 1.8 cm, in melaminico / Modesty panel 18 mm thick, in melamine



Mobili di servizio/Service units

Scocca e ripiani sp. 1.8 cm, in melaminico / Bodies and shelves 1.8 cm thick, in melamine



Ante scorrevoli sp. 1.8 cm, in melaminico con bordo ABS sp. 0.15 cm colore alluminio / Sliding doors 1.8 cm thick, in melamine with aluminium-coloured ABS edge-profiles 0.15 cm thick

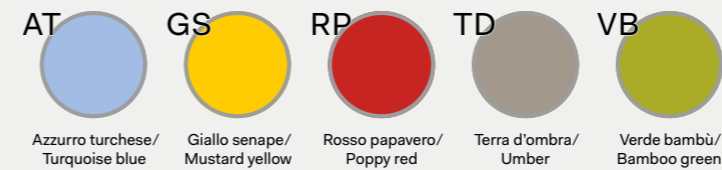



Ante scorrevoli sp. 1.8 cm, in melaminico con bordo ABS sp. 0.15 cm in tinta / Sliding doors 1.8 cm thick, in melamine with ABS edge-profiles 0.15 cm thick, in same color



Note

Per i colori e le finiture dei Frontal Panels, vedere il relativo capitolo in DV300 - Accessori. / For colours and finishes of Frontal Panels, see the chapter in DV300 - Accessories.

 Prodotti non in pronta consegna. Per la disponibilità contattare l'ufficio commerciale. / Items not in prompt delivery. Please contact the commercial department to check availability.

 Fino ad esaurimento. / Until exhaustion.

Piani di lavoro in melaminico sp. 18 mm con bordi perimetrali in ABS/Worktops in melamine 23/32" thick with perimetrical edges in ABS

Tavoli scrivania P 65/Desks 65 depth

P 65 x H 74

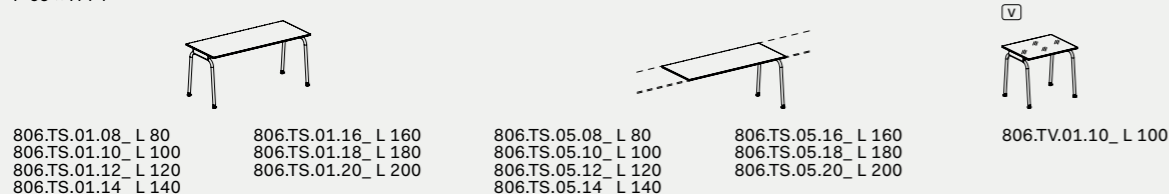

Tavoli scrivania P 80/Desks 80 depth

P 80 x H 74

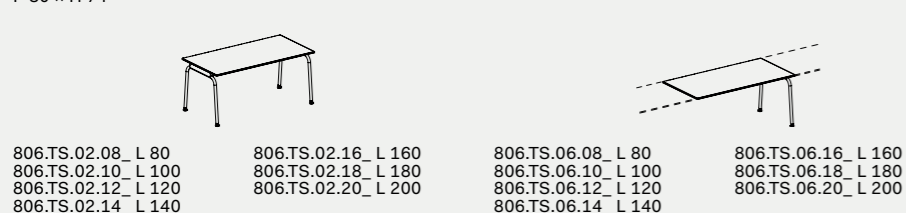

Tavoli executive P 90/90 depth executive tables

P 90 x H 74

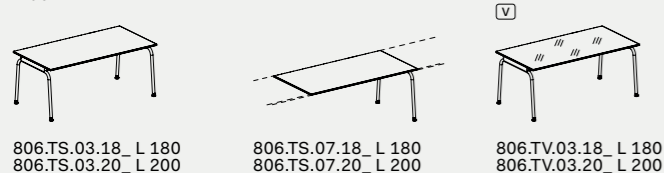

Tavoli riunioni/Meeting tables

P 120 x H 74



Tavoli scrivania P 136,5/Desks 136,5 depth

P 136,5 x H 74

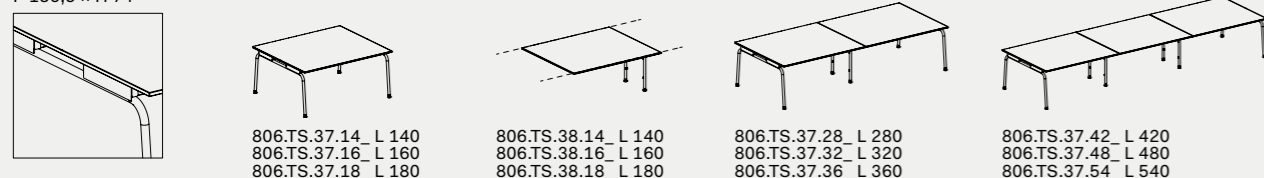

Tavoli P 136,5 a 2 scrivanie contrapposte/Benches 136,5 depth

P 136,5 x H 74

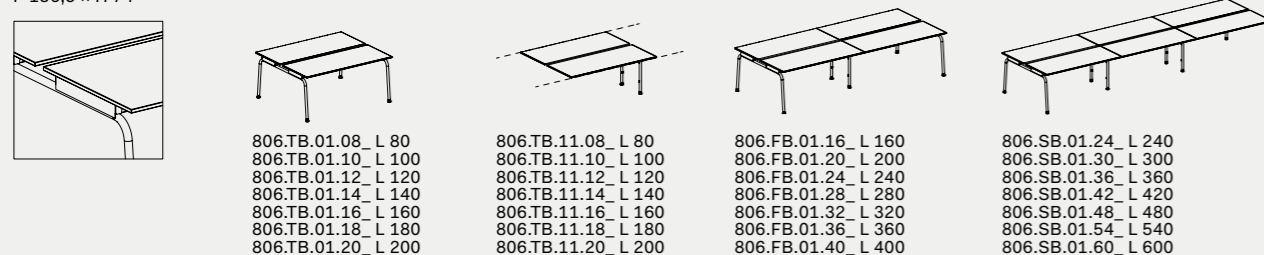

Tavoli P 136,5 a 2 scrivanie contrapposte + binario centrale/Benches 136,5 depth + central rail

P 136,5 x H 74

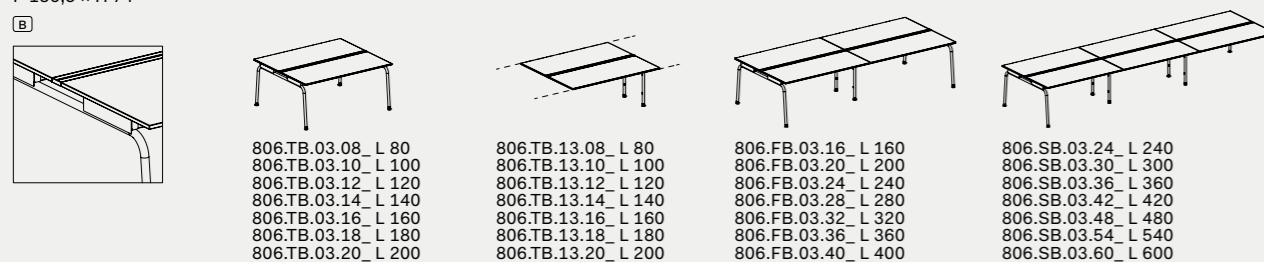

Piani di lavoro in melaminico sp. 18 mm con bordi perimetrali in ABS/Worktops in melamine 23/32" thick with perimetrical edges in ABS

Tavoli P 158 a 2 scrivanie contrapposte + binario centrale con 2 sportelli/Benches 158 depth + central rail with 2 flip-up covers

P 158 x H 74

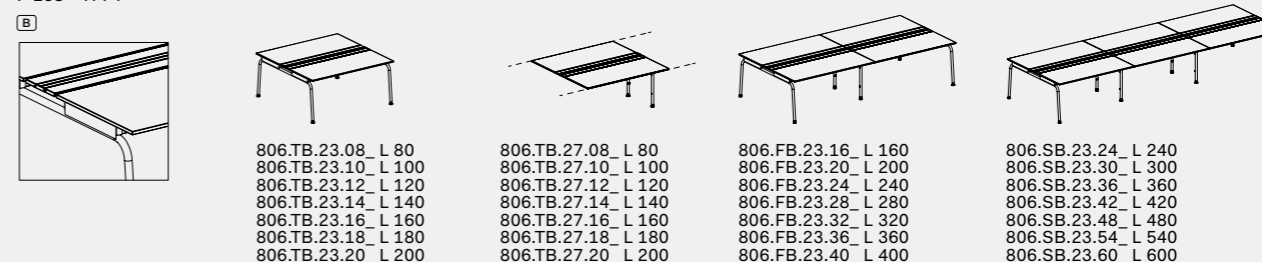

Tavoli scrivania doppia P 158 con asole e 2 top access/Benches 158 cm depth with slots and 2 top access

P 158 x H 74

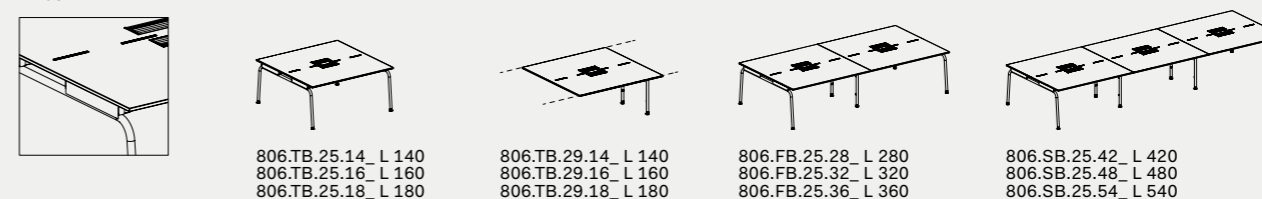

Tavoli P 166,5 a 2 scrivanie contrapposte/Benches 166,5 depth

P 166,5 x H 74

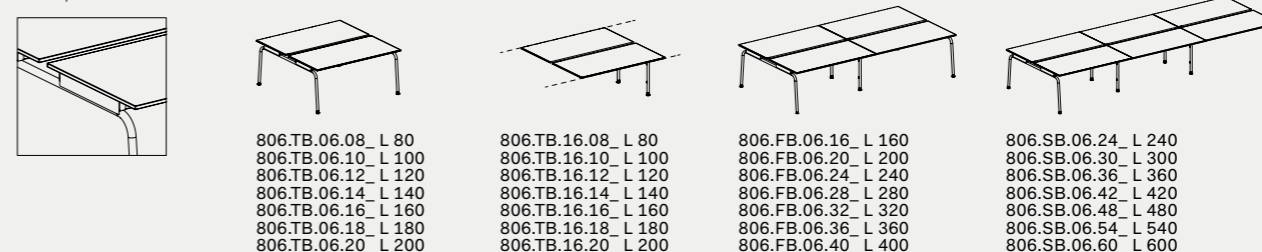

Tavoli P 166,5 a 2 scrivanie contrapposte + binario centrale/Benches 166,5 depth + central rail

P 166,5 x H 74

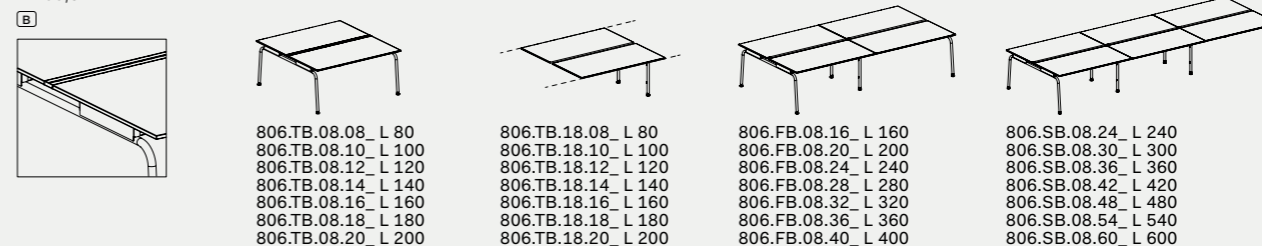

Allunghi laterali/Lateral extensions

P 65 x H 74



806.TD.01.08_L 80
806.TD.01.10_L 100
806.TD.01.12_L 120

P 80 x H 74



806.TD.02.08_L 80
806.TD.02.10_L 100
806.TD.02.12_L 120

P 65 x H 74



806.DV.01.10_L 100

P 65 x H 1,8



806.AL.01.08_L 80
806.AL.01.10_L 100
806.AL.01.12_L 120

Note:

Le dimensioni sono espresse in cm - consultare il listino prezzi per le caratteristiche tecniche, i codici degli articoli e delle finiture/Dimensions are stated in cm - for technical characteristics, article code numbers and finishing see price list;

Prodotti non in pronta consegna. Per la disponibilità contattare l'ufficio commerciale/Items not in prompt delivery. Please contact the commercial department to check availability;

Tutta la serie DV806 è disponibile fino ad esaurimento scorte; / The whole DV806 serie is available until the exhaustion of stocks;

Con binario centrale/With central rail;

Con serratura/With lock;

Vetro/Glass.

Piani di lavoro in melaminico sp. 18 mm con bordi perimetrali in ABS / Worktops in melamine 23/32" thick with perimetrical edges in ABS

Cassettiere/Pedestals

L 42 P 57 x H 55,5 	L 42 P 57 x H 55,5 	L 32,2 P 54,2 x H 55,5 	L 32,2 P 54,2 x H 55,5 	L 42,2 P 54,2 x H 55,5 	L 42,2 P 54,2 x H 55,5 	L 33 P 53 x H 44 	L 32,5 P 52 x H 14,5
550.CS.10.04 Melaminico/Melamine	550.CS.20.04 Melaminico/Melamine	550.CS.1M.03 Metalliche/Metallic	550.CS.2M.03 Metalliche/Metallic	550.CS.1M.04 Metalliche - Vaschetta porta cancelleria inclusa/Metallic - Stationery tray included	550.CS.2M.04 Metalliche - Vaschetta porta cancelleria inclusa/Metallic - Stationery tray included	806.CS.11.03 Sospesa melaminico /Hanged melamine	806.CA.01.05 Sospesa metallica /Hanged metallic

Note: La finitura impiallacciato non è in pronta consegna. Per la disponibilità contattare l'ufficio commerciale. Per portacassettiera cassetti, vedi capitolo DV300-Accessori/Veneered finishes is not in prompt delivery. Please contact the commercial department to check availability. For stationary tray, see chapter DV300-Accessories

Cassettiere portanti/Carrying pedestals

L 42 P 65 x H 71,5 	L 42 P 65 x H 71,5 	H 1,8 	H 2,5
550.CS.30.04	550.CS.40.04	550.CG.13.04 Top	550.CG.11.04 Zoccolo (Optional) /Base frame (Optional)

Contenitori H 74/Storage units H 74

L 80 P 33 x 71,5 	H 1,8 	H 2,5
550.CG.01.08 A giorno/Open	550.CG.13.08 Top	550.CG.11.08 Zoccolo (Optional) /Base frame (Optional)

Tavoli integrabili su mobile di servizio/Desks to be completed with service unit

P 65 x H 74 	P 80 x H 74 	P 90 x H 74 	H 74 	P 136,5 x H 74 	P 136,5 x H 74
806.TI.01.16_L 160 806.TI.01.18_L 180 806.TI.01.20_L 200	806.TI.02.16_L 160 806.TI.02.18_L 180 806.TI.02.20_L 200	806.TI.12.18_L 180 806.TI.12.20_L 200	806.TI.03.18_L 180 806.TI.03.20_L 200	806.TI.20.12_Ø120	806.TI.04.14_L 140 806.TI.04.16_L 160 806.TI.04.18_L 180

Piani/Worktops

P 65 x H 1,8 	P 80 x H 1,8 	P 136,5 x H 1,8 	P 136,5 x H 1,8 	P 158 x H 1,8 	P 166,5 x H 1,8 	P 166,5 x H 1,8
806.PS.01.08_L 80 806.PS.01.10_L 100 806.PS.01.12_L 120 806.PS.01.14_L 140 806.PS.01.16_L 160 806.PS.01.18_L 180 806.PS.01.20_L 200	806.PS.02.08_L 80 806.PS.02.10_L 100 806.PS.02.12_L 120 806.PS.02.14_L 140 806.PS.02.16_L 160 806.PS.02.18_L 180 806.PS.02.20_L 200	806.PB.01.08_L 80 806.PB.01.10_L 100 806.PB.01.12_L 120 806.PB.01.14_L 140 806.PB.01.16_L 160 806.PB.01.18_L 180 806.PB.01.20_L 200	806.PB.03.08_L 80 806.PB.03.10_L 100 806.PB.03.12_L 120 806.PB.03.14_L 140 806.PB.03.16_L 160 806.PB.03.18_L 180 806.PB.03.20_L 200	806.PB.23.08_L 80 806.PB.23.10_L 100 806.PB.23.12_L 120 806.PB.23.14_L 140 806.PB.23.16_L 160 806.PB.23.18_L 180 806.PB.23.20_L 200	806.PB.06.08_L 80 806.PB.06.10_L 100 806.PB.06.12_L 120 806.PB.06.14_L 140 806.PB.06.16_L 160 806.PB.06.18_L 180 806.PB.06.20_L 200	806.PB.08.08_L 80 806.PB.08.10_L 100 806.PB.08.12_L 120 806.PB.08.14_L 140 806.PB.08.16_L 160 806.PB.08.18_L 180 806.PB.08.20_L 200

Note:
 [1] Le dimensioni sono espresse in cm - consultare il listino prezzi per le caratteristiche tecniche, i codici degli articoli e delle finiture/Dimensions are stated in cm - for technical characteristics, article code numbers and finishing see price list;
 [2] Prodotti non in pronta consegna. Per la disponibilità contattare l'ufficio commerciale/Items not in prompt delivery. Please contact the commercial department to check availability;
 [3] Con binario centrale/With central rail;
 [4] Con serratura/With lock;
 [5] Tutta la serie DV806 è disponibile fino ad esaurimento scorte; / The whole DV806 serie is available until the exhaustion of stocks;
 [6] Vetro/Glass.

Piani di lavoro in melaminico sp. 18 mm con bordi perimetrali in ABS / Worktops in melamine 23/32" thick with perimetrical edges in ABS

Mobili di servizio con ante scorrevoli/Service units with sliding doors

L 160 P 48 x H 58 	L 160 P 48 x H 58
806.MS.02.16 Monofacciale/Uniface	806.MS.01.16 Bifacciale/Bifacial

Optional 806.CA.01.03, Optional 503.CS.P1.00, Optional 503.CS.A5.04
 Optional per cod. 806.MS.02.16 / 806.MS.01.16
 Optional for code 806.MS.02.16 / 806.MS.01.16

Componenti per tavoli/Components for desk

P 65 x H 1,8 	P 80 x H 1,8
806.PD.01.08_L 80 806.PD.01.10_L 100 806.PD.01.12_L 120	806.PD.02.08_L 80 806.PD.02.10_L 100 806.PD.02.12_L 120

Piani terminali/Terminal tops

P 40 x H 1,8 	P 65 x H 74 	H 74
806.PT.01.13_L 136,5 806.PT.01.15_L 158 806.PT.01.16_L 166,5	806.PT.02.13_L 136,5 806.PT.02.15_L 158 806.PT.02.16_L 166,5	806.PT.20.13_L 130 Collegabile solo a piani P. 65 /For integration with worktop P. 65

Gambe fisse terminali inclinate/Tilted fix terminal legs

P 5 x H 72,2 	P 5 x H 72,2
806.GF.01.06_L 65 806.GF.01.08_L 80 806.GF.01.09_L 90 806.GF.01.12_L 120 806.GF.01.13_L 136,5 806.GF.01.15_L 158 806.GF.01.16_L 166,5	806.GF.02.06_L 65 806.GF.02.08_L 80 806.GF.02.09_L 90 806.GF.02.12_L 120 806.GF.02.13_L 136,5 806.GF.02.15_L 158 806.GF.02.16_L 166,5

Gambe fisse intermedie/Fix middle legs

P 5 x H 72,2 	P 5 x H 72,2
806.GF.03.06_L 65 806.GF.03.08_L 80 806.GF.03.09_L 90	806.GF.04.12_L 120 806.GF.04.13_L 136,5 806.GF.04.15_L 158 806.GF.04.16_L 166,5

Carter/Casing

806.GC.01.05_L 120 - 136,5 806.GC.02.07_L 158 - 166,5 Coppia carter per gambe intermedie /Pair of casings for middle legs

Supporto per mobile di servizio /Support for service unit

P 13 x H 14,5 	
806.KT.01.06_L 65 806.KT.01.08_L 80 806.KT.01.09_L 90	806.KT.01.13_L 136,5 806.KT.01.15_L 158 806.KT.01.16_L 166,5

Gamba colonna fissa/Fix column leg

L 5 P 5 x H 72,2
806.GF.05.01

Modesty panels

P 1,8 x H 35 	P 5 x H 5,1
806.MP.01.08_L 80 806.MP.01.10_L 100 806.MP.01.12_L 120 806.MP.01.14_L 140 806.MP.01.16_L 160 806.MP.01.18_L 180 806.MP.01.20_L 200 Per tavoli/For desks	806.ST.01.06_L 35,5 [3] 65 806.ST.01.08_L 48,3 [3] 80 806.ST.01.09_L 58,3 [3] 90 Staffa da aggiungere ai modesty panel per mobili di servizio in base alla profondità del piano di lavoro. N.B.: Per l'integrazione consultare il relativo listino / Bracket to be added to the modesty panels for service units, depending on worktop's depth. NOTES: Check the correspondent price list for the integration

Note:
 [1] Le dimensioni sono espresse in cm - consultare il listino prezzi per le caratteristiche tecniche, i codici degli articoli e delle finiture/Dimensions are stated in cm - for technical characteristics, article code numbers and finishing see price list;
 [2] Prodotti non in pronta consegna. Per la disponibilità contattare l'ufficio commerciale/Items not in prompt delivery. Please contact the commercial department to check availability;
 [3] Con binario centrale/With central rail;
 [4] Con serratura/With lock;
 [5] Tutta la serie DV806 è disponibile fino ad esaurimento scorte; / The whole DV806 serie is available until the exhaustion of stocks;
 [6] Vetro/Glass.

Morsetti e supporti in per frontal panels Sp. 0,5 - 0,8 - 1 - 3 / Clamps for frontal panels T. 0,5 - 0,8 - 1 - 3

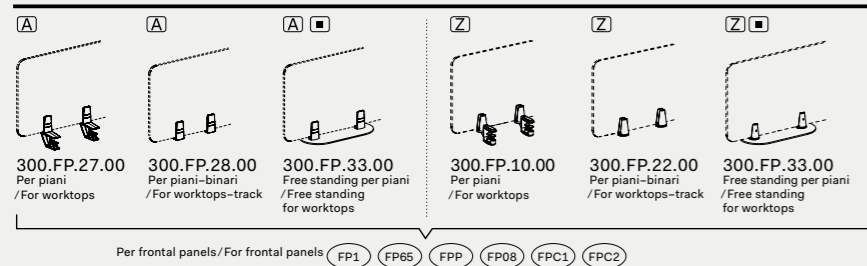

Frontal panels Sp. 0,8 - 1

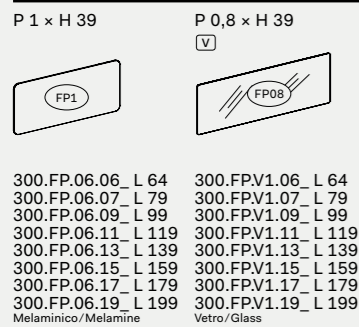

Frontal panel fonoassorbenti Sp. 3 / Acoustic frontals panels T. 3

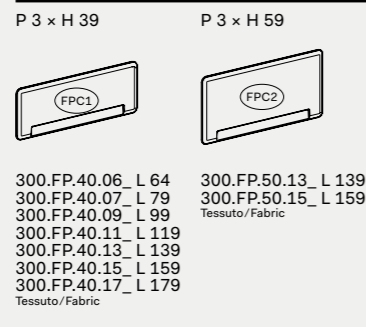

Frontal panels H 65

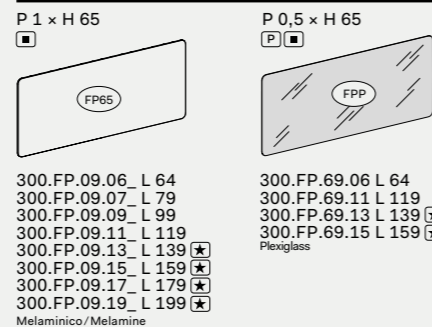

N.B.: Per i frontal con lunghezza maggiore o uguale ai 139 cm, ordinare 2 kit di supporti per frontal panel / Note: For frontal panels with a length greater than or equal to 139 cm, order 2 kits of clamps-supports for frontal panels

Frontal panels con morsetti e supporti integrati / Frontal panels with clamps and conic clamps

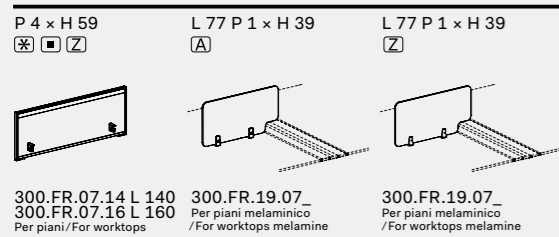

In caso di BENCH, controllare lo spazio disponibile tra una gamba e l'altra / In the case of BENCH, verify the useful gap between a leg and the next one

Frontal panels H 65 con supporto freestanding integrato / Frontal panels with freestanding bracket integrated

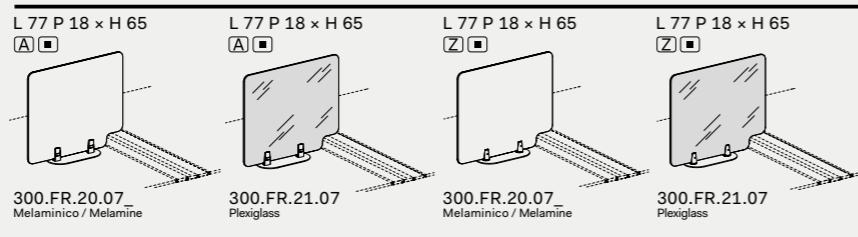

Accessori per frontal panels in melaminico / Accessories for melamine frontal panels

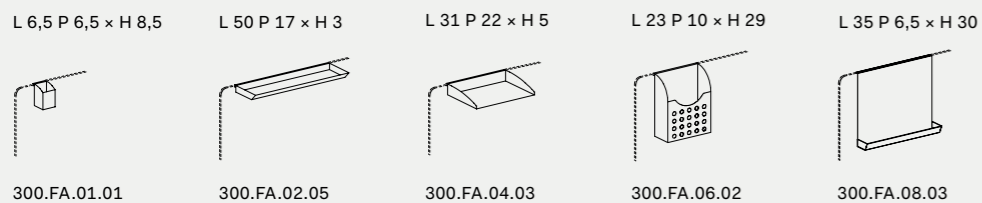

Note: Il posizionamento degli accessori sui frontal panel in vetro prevede l'utilizzo di una guarnizione in PVC trasparente (Optional su richiesta) / Placement of accessories on glass front panel need the use of a transparent PVC gasket (Optional on request) / Non utilizzabile sui frontal panels in plexiglass e frontal panels in tessuto fonoassorbente / Not usable for plexiglass frontal panels and acoustic frontal panels

Accessori su binari / Accessories on rail

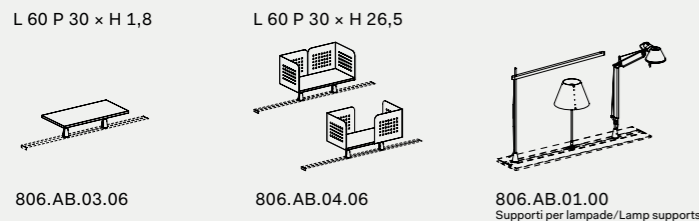

Porta dox / Top box

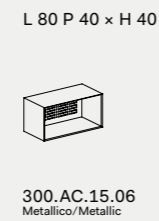

Note:

Le dimensioni sono espresse in cm - consultare il listino prezzi per le caratteristiche tecniche, i codici degli articoli e delle finiture / Dimensions are stated in cm - for technical characteristics, article code numbers and finishing see price list;

Prodotti non in pronta consegna. Per la disponibilità contattare l'ufficio commerciale / Items not in prompt delivery. Please contact the commercial department to check availability;

Tutta la serie DV806 è disponibile fino ad esaurimento scorte; / The whole DV806 serie is available until the exhaustion of stocks;

- V Vetro / Glass.
- P Plexiglass
- Z Morsetti o supporti in ZAMA / Zamak clamps
- A Morsetti o supporti in ABS / ABS clamps

Canalizzazione - Elettrificazione - Accessori / Wire management - Electrification - Accessories

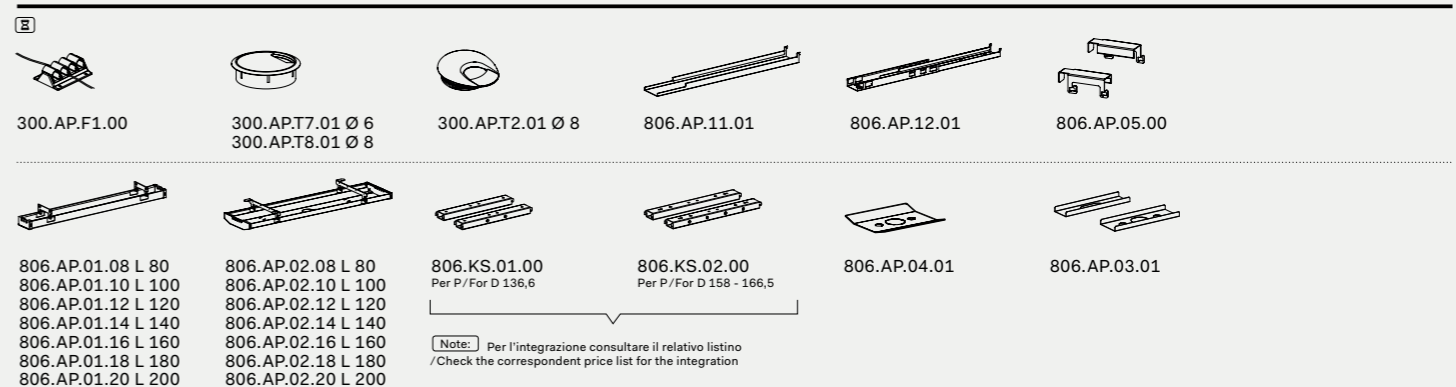

Note: Per l'integrazione consultare il relativo listino / Check the correspondent price list for the integration

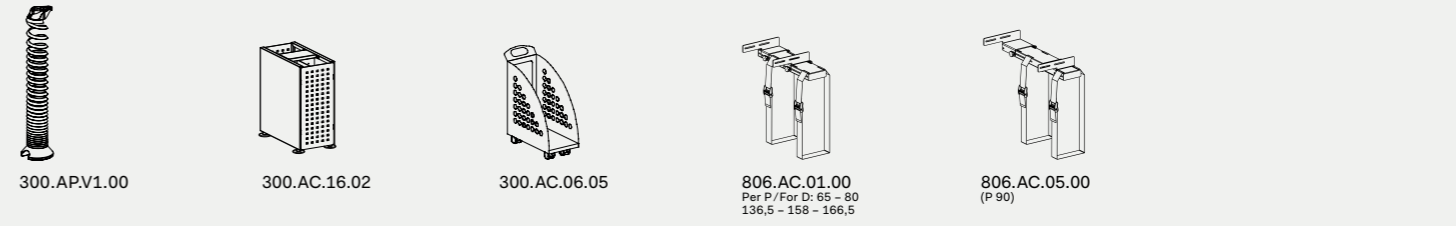
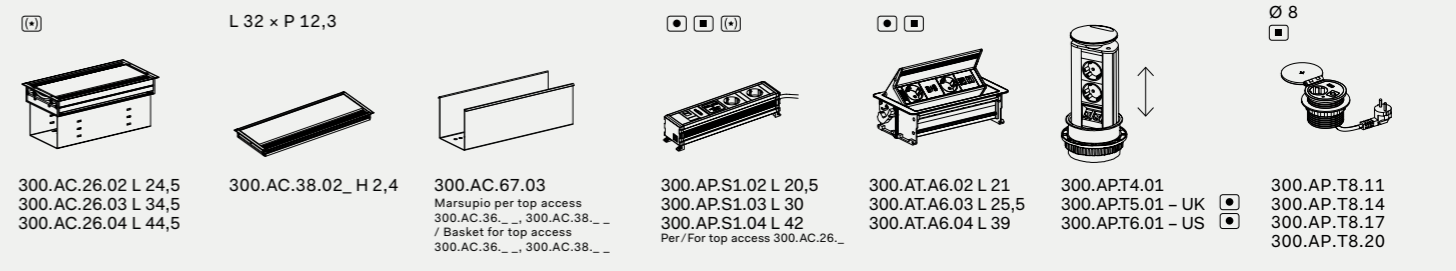

Bracci porta video / Arms for video support

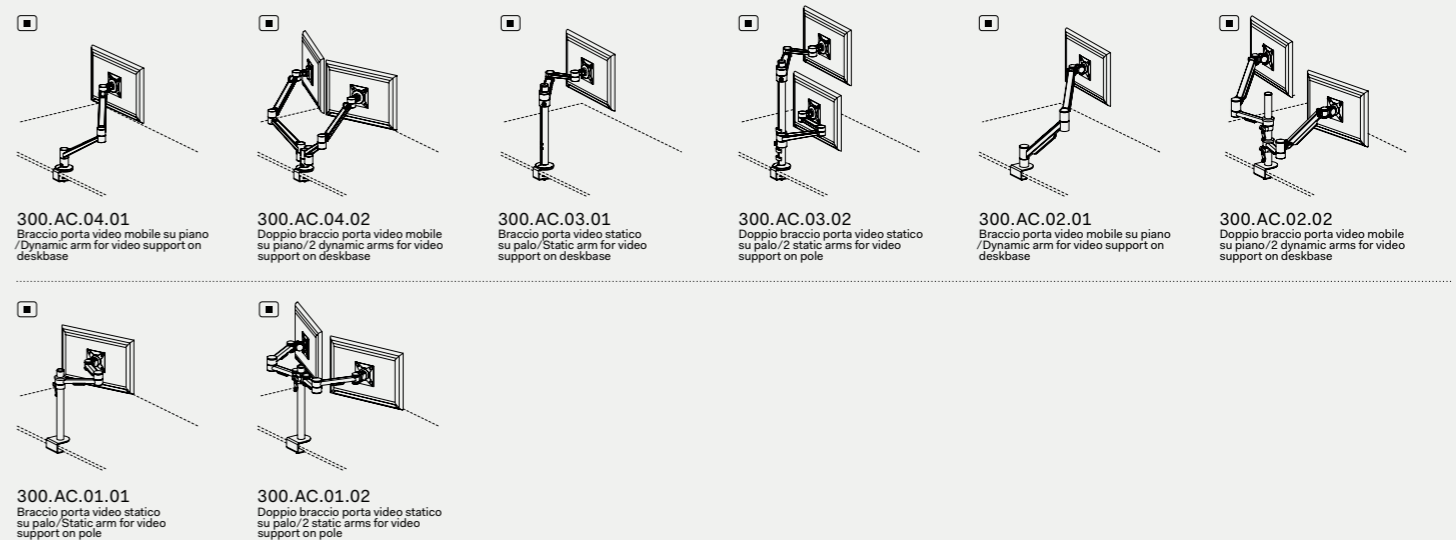

Note:

Le dimensioni sono espresse in cm - consultare il listino prezzi per le caratteristiche tecniche, i codici degli articoli e delle finiture / Dimensions are stated in cm - for technical characteristics, article code numbers and finishing see price list;

Prodotti non in pronta consegna. Per la disponibilità contattare l'ufficio commerciale / Items not in prompt delivery. Please contact the commercial department to check availability;

Tutta la serie DV806 è disponibile fino ad esaurimento scorte; / The whole DV806 serie is available until the exhaustion of stocks;

- Articoli prodotti solo su richiesta / Items produced only on demand;
- Fino ad esaurimento / Until exhaustion;

DV804 E-Place

Design:
Perin & Topan

Comp. N°1

IT Originali tipologie di arredo per spazi operativi – Versatile, giovane e funzionale. Sistema con grandissima facilità di installazione. Un prodotto destinato a comporre spazi d'arredo operativi e direzionali completi, al passo con l'evoluzione del lavoro. Leggerezza formale e stile, ingredienti principali di un sistema operativo caratterizzato da tavoli con struttura su gambe a cavalletto in versione singola o bench.

EN Original furnishing solutions for workstations – Versatile, fresh styled and functional, a range with an extremely easy assembly system. This series fully furnishes operative and executive spaces, in line with today's work evolutions. Formal lightness and style are the main ingredients of an operational system characterized by tables with trestle legs, in single or bench version.







DV804 E-Place

Design:
Perin & Topan

Comp. N°2







DV804 E-Place

Design:
Perin & Topan

Comp. N°3





DV804 E-Place

Design:
Perin & Topan

Comp. N°4





DV804 E-Place

Design:
Perin & Topan

Comp. N°5









Tavoli/Tables

Piani di lavoro sp. 2.5 cm, in melaminico con bordi perimetrali in ABS sp. 0.2 cm / Worktops 2.5 cm thick, in melamine with 0.2 cm ABS edge-profiles
Modesty panel sp. 1.8 cm, in melaminico/Modesty panel 1.8 cm thick, in melamine



Strutture metalliche/Metal structures



Mobili di servizio/Service units

Scocca e ripiani sp. 1.8 cm, in melaminico/Bodies and shelves 1.8 cm thick, in melamine



Ante scorrevoli sp. 1.8 cm, in melaminico con bordo ABS sp. 0.15 cm colore alluminio/Sliding doors 1.8 cm thick, in melamine with aluminium-coloured ABS edge-profiles 0.15 cm thick

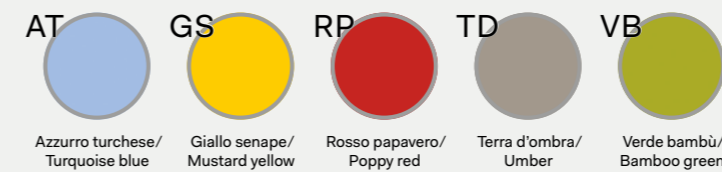

Ante scorrevoli sp. 1.8 cm, in melaminico con bordo ABS sp. 0.15 cm in tinta/Sliding doors 1.8 cm thick, in melamine with ABS edge-profiles 0.15 cm thick, in same color





Note

Per i colori e le finiture dei Frontal Panels, vedere il relativo capitolo in DV300 - Accessori. / For colours and finishes of Frontal Panels, see the chapter in DV300 - Accessories.
 Prodotti non in pronta consegna. Per la disponibilità contattare l'ufficio commerciale. / Items not in prompt delivery. Please contact the commercial department to check availability.
 Fino ad esaurimento. / Until exhaustion.

Piani di lavoro in melaminico sp. 25 mm con bordi perimetrali in ABS sp. 2 mm / Worktops in melamine 1" thick with perimetrical edges in ABS 2/32" thick

Tavoli scrivanie/Desks

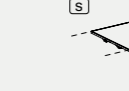
<p>P 65 x H 74</p>  <p>804.TS.01.08_ L 80 804.TS.01.10_ L 100 804.TS.01.14_ L 140 804.TS.01.16_ L 160 804.TS.01.18_ L 180</p>	<p>P 65 x H 74</p>  <p>804.TS.05.08_ L 80 804.TS.05.10_ L 100 804.TS.05.14_ L 140 804.TS.05.16_ L 160 804.TS.05.18_ L 180</p>	<p>P 80 x H 74</p>  <p>804.TS.02.14_ L 140 804.TS.02.16_ L 160 804.TS.02.18_ L 180 804.TS.02.20_ L 200</p>	<p>P 80 x H 74</p>  <p>804.TS.06.14_ L 140 804.TS.06.16_ L 160 804.TS.06.18_ L 180 804.TS.06.20_ L 200</p>
---	--	---	---

Tavoli P 136,5 a 2 scrivanie contrapposte/Benches 136,5 depth

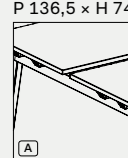
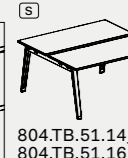
<p>P 136,5 x H 74</p>  <p>804.TB.51.14_ L 140 804.TB.51.16_ L 160</p>	<p>P 136,5 x H 74</p>  <p>804.TB.61.14_ L 140 804.TB.61.16_ L 160</p>
---	--

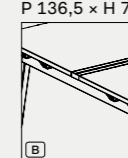
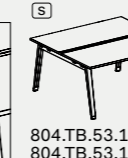

Tavoli a 2 scrivanie contrapposte p 136,5 + binario centrale / Benches 136,5 depth + central rail

<p>P 136,5 x H 74</p>  <p>804.TB.53.14_ L 140 804.TB.53.16_ L 160</p>	<p>P 136,5 x H 74</p>  <p>804.TB.63.14_ L 140 804.TB.63.16_ L 160</p>
--	--

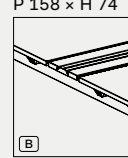
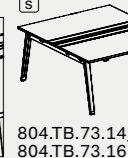
Tavoli P 158 a 2 scrivanie contrapposte + binario centrale con 2 sportelli/Benches 158 depth + central rail with 2 flip-up covers

<p>P 158 x H 74</p>  <p>804.TB.73.14_ L 140 804.TB.73.16_ L 160</p>	<p>P 158 x H 74</p>  <p>804.TB.77.14_ L 140 804.TB.77.16_ L 160</p>
---	--

Tavoli a 2 scrivanie contrapposte p 166,5 + binario centrale / Benches 166,5 depth + central rail

<p>P 166,5 x H 74</p>  <p>804.TB.58.14_ L 140 804.TB.58.16_ L 160</p>	<p>P 166,5 x H 74</p>  <p>804.TB.68.14_ L 140 804.TB.68.16_ L 160</p>
--	--

Tavoli P 166,5 a 2 scrivanie contrapposte/Benches 166,5 depth

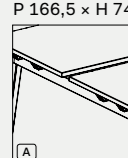
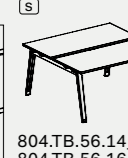
<p>P 166,5 x H 74</p>  <p>804.TB.56.14_ L 140 804.TB.56.16_ L 160</p>	<p>P 166,5 x H 74</p>  <p>804.TB.66.14_ L 140 804.TB.66.16_ L 160</p>
---	--



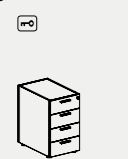
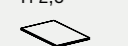
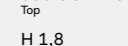

Cassettiere portanti/Carrying pedestals

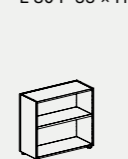
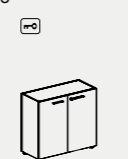
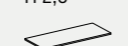
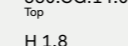
<p>L 42 P 65 x H 71,5</p>  <p>550.CS.30.04_</p>	<p>L 42 P 65 x H 71,5</p>  <p>550.CS.40.04_</p>	<p>H 2,5</p>  <p>550.CG.14.04_ Top</p>	<p>H 1,8</p>  <p>550.CG.12.04 Zoccolo (Optional) /Base frame (Optional)</p>
---	--	---	--

Contenitori H 74/Storage units H 74

<p>L 80 P 33 x H 71,5</p>  <p>550.CG.01.08_ A giorno/Open</p>	<p>L 80 P 33 x H 71,5</p>  <p>550.CC.02.08_ Con ante/With doors</p>	<p>H 2,5</p>  <p>550.CG.14.08_ Top</p>	<p>H 1,8</p>  <p>550.CG.12.08 Zoccolo (Optional) /Base frame (Optional)</p>
--	--	---	--

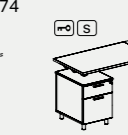
Allunghi laterali e su cassettiere portanti / Lateral extensions and extensions on carrying pedestals

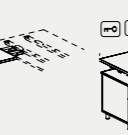
<p>P 65 x H 74</p>  <p>804.TD.01.08_ L 80 804.TD.01.10_ L 100</p>	<p>L 100 P 65 x H 74</p>  <p>804.AL.04.10_</p>	<p>L 100 P 65 x H 74</p>  <p>804.AL.05.10_</p>	<p>L 100 P 65 x H 74</p>  <p>804.TD.03.10_</p>	<p>L 100 P 65 x H 74</p>  <p>804.TD.04.10_</p>
---	---	---	---	---

Modesty panels

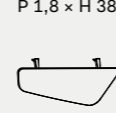
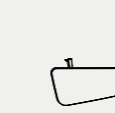



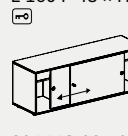
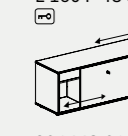



<p>P 1,8 x H 38</p>  <p>Dx/R</p> <p>804.MP.02.11_ L 110 804.MP.02.14_ L 140</p>	<p>P 1,8 x H 38</p>  <p>Sx/L</p> <p>804.MP.03.11_ L 110 804.MP.03.14_ L 140</p>
--	--

Mobili di servizio/Service units

<p>L 160 P 48 x H 58</p>  <p>804.MS.02.16_ Monofacciale/Uniface</p>	<p>L 160 P 48 x H 58</p>  <p>804.MS.01.16_ Bifacciale/Bifacial</p>	<p>Optional per cod. 804.MS.02.16_ /804.MS.01.16_ /Optional for code 804.MS.02.16_ /804.MS.01.16_</p> <p>Optional 804.CA.01.03</p> <p>Optional 503.CS.P1.00</p> <p>Optional 503.CS.A5.04</p>
---	---	--





Piani di lavoro in melaminico sp. 25 mm con bordi perimetrali in ABS sp. 2 mm / Worktops in melamine 1" thick with perimetrical edges in ABS 2/32" thick



Cassettiere/Pedestals

<p>L 42 P 57 x H 55,5</p>  <p>550.CS.10.04_ Melaminico/Melamine</p>	<p>L 42 P 57 x H 55,5</p>  <p>550.CS.20.04_ Melaminico/Melamine</p>	<p>L 32,2 P 54,2 x H 55,5</p>  <p>550.CS.1M.03_ Metalliche/Metallic</p>	<p>L 32,2 P 54,2 x H 55,5</p>  <p>550.CS.2M.03_ Metalliche/Metallic</p>	<p>L 42,2 P 54,2 x H 55,5</p>  <p>550.CS.1M.04_ Metalliche - Vaschetta porta cancelleria inclusa/Metallic - Stationery tray included</p>	<p>L 42,2 P 54,2 x H 55,5</p>  <p>550.CS.2M.04_ Metalliche - Vaschetta porta cancelleria inclusa/Metallic - Stationery tray included</p>	<p>L 33 P 53 x H 35</p>  <p>804.CS.11.03_ Sospesa melaminico /Hanged melamine</p>	<p>L 32,5 P 52 x H 7</p>  <p>804.CA.01.05_ Sospesa metallica /Hanged metallic</p>
--	--	--	--	---	---	--	--

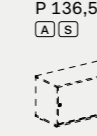

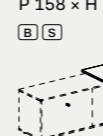

Note: La finitura impiallacciato non è in pronta consegna. Per la disponibilità contattare l'ufficio commerciale. Per portacancelleria cassetti, vedi capitolo DV300-Accessori/Veneered finishes is not in prompt delivery. Please contact the commercial department to check availability. For stationary tray, see chapter DV300-Accessories



Tavoli integrabili su mobili di servizio/Integrable desks for service units

<p>P 65 x H 74</p>  <p>804.TI.01.14_ L 140 804.TI.01.16_ L 160 804.TI.01.18_ L 180</p>	<p>P 80 x H 74</p>  <p>804.TI.02.14_ L 140 804.TI.02.16_ L 160 804.TI.02.18_ L 180</p>	<p>P 136,5 x H 74</p>  <p>804.TI.54.14_ L 140 804.TI.54.16_ L 160</p>	<p>P 166,5 x H 74</p>  <p>804.TI.55.14_ L 140 804.TI.55.16_ L 160</p>
---	---	--	--





<p>P 158 x H 74</p>  <p>804.TI.56.14_ L 140 804.TI.56.16_ L 160</p>	<p>P 136,5 x H 74</p>  <p>804.TI.57.14_ L 140 804.TI.57.16_ L 160</p>	<p>P 166,5 x H 74</p>  <p>804.TI.58.14_ L 140 804.TI.58.16_ L 160</p>
--	--	--

Raccordi/Connection elements

<p>L 80 P 80 x H 2,5</p>  <p>804.RA.01.08_</p>	<p>L 80 P 80 x H 74</p>  <p>804.RA.02.08_</p>	<p>L 80 P 65 x H 2,5</p>  <p>804.RA.03.08_ Dx/R 804.RA.04.08_ Sx/L</p>	<p>L 80 P 40 x H 5,5</p>  <p>804.PT.07.08_</p>
---	--	---	---

<p>L 136,5 P 68 x H 74</p>  <p>804.PT.09.13_</p>	<p>L 158 P 79 x H 74</p>  <p>804.PT.10.15_</p>	<p>L 166,5 P 83 x H 74</p>  <p>804.PT.13.16_</p>
---	---	---

Piani terminali/ Terminal tops

<p>P 40 x H 2,5</p>  <p>804.PT.01.13_ L 136,5 804.PT.01.15_ L 158 804.PT.01.16_ L 166,5</p>	<p>P 65 x H 74</p>  <p>804.PT.02.13_ L 136,5 804.PT.02.15_ L 158 804.PT.02.16_ L 166,5</p>	<p>P 40 x H 41</p>  <p>804.CT.02.13_ L 136,5 804.CT.02.15_ L 158 804.CT.02.16_ L 166,5</p>	<p>P 40 x H 41</p>  <p>804.CT.04.13_ L 136,5 804.CT.04.15_ L 158 804.CT.04.16_ L 166,5</p>	<p>804.CT.05.00_ Kit per sovrapposizione contenitori terminali con ante scorrevoli/Kit for stacking terminal storage units with sliding doors</p>
--	---	---	---	---

- Note:
- 1 Le dimensioni sono espresse in cm - consultare il listino prezzi per le caratteristiche tecniche, i codici degli articoli e delle finiture/Dimensions are stated in cm - for technical characteristics, article code numbers and finishing see price list;
 - 2 Prodotti non in pronta consegna. Per la disponibilità contattare l'ufficio commerciale/Items not in prompt delivery. Please contact the commercial department to check availability;
 - 3 Con serratura /With lock.
 - 4 Da utilizzare solo con tavoli indipendenti /To be used with single desks
 - 5 Senza binario /Without rail;
 - 6 Con binario centrale /With central rail;
 - 7 Fino ad esaurimento /Until exhaustion;

Piani di lavoro in melaminico sp. 25 mm con bordi perimetrali in ABS sp. 2 mm/Worktops in melamine 1" thick with perimetrical edges in ABS 2/32" thick

Tavoli riunione/Meeting tables

H 74	H 74	L 140 P 140 x H 74	P 120 x H 74	P 120 x H 74	P 120 x H 74
804.TR.11.10_Ø 100 804.TR.11.12_Ø 120	804.TR.21.10_Ø 100 804.TR.21.12_Ø 120	804.TR.32.14_R	804.TR.32.24_L 240 R 804.TR.32.30_L 300 R	804.TR.06.24_L 240 S	804.TR.03.24_L 240 R 804.TR.03.30_L 300 R

Morsetti e supporti in per frontal panels Sp. 0,5 - 0,8 - 1 - 3/Clamps for frontal panels T. 0,5 - 0,8 - 1 - 3

300.FP.27.00 Per piani /For worktops	300.FP.28.00 Per piani-binari /For worktops-track	300.FP.33.00 Free standing per piani /Free standing for worktops	300.FP.10.00 Per piani /For worktops	300.FP.22.00 Per piani-binari /For worktops-track	300.FP.33.00 Free standing per piani /Free standing for worktops
Per frontal panels/For frontal panels (FP1) (FP65) (FPP) (FP08) (FPC1) (FPC2)					

Frontal panels Sp. 0,8 - 1

P 1 x H 39	P 0,8 x H 39
300.FP.06.06_L 64 300.FP.06.07_L 79 300.FP.06.09_L 99 300.FP.06.11_L 119 300.FP.06.13_L 139 300.FP.06.15_L 159 300.FP.06.17_L 179 300.FP.06.19_L 199 Melaminico/Melamine	300.FPV1.06_L 64 300.FPV1.07_L 79 300.FPV1.09_L 99 300.FPV1.11_L 119 300.FPV1.13_L 139 300.FPV1.15_L 159 300.FPV1.17_L 179 300.FPV1.19_L 199 Vetro/Glass

Frontal panel fonosorbenti Sp. 3 /Acoustic frontals panels T. 3

P 3 x H 39	P 3 x H 59
300.FP.40.06_L 64 300.FP.40.07_L 79 300.FP.40.09_L 99 300.FP.40.11_L 119 300.FP.40.13_L 139 300.FP.40.15_L 159 300.FP.40.17_L 179 Tessuto/Fabric	300.FP.50.13_L 139 300.FP.50.15_L 159 Tessuto/Fabric

Fontal panels H 65

P 1 x H 65	P 0,5 x H 65
300.FP.09.06_L 64 300.FP.09.07_L 79 300.FP.09.09_L 99 300.FP.09.11_L 119 300.FP.09.13_L 139 300.FP.09.15_L 159 300.FP.09.17_L 179 300.FP.09.19_L 199	300.FP.69.06 L 64 300.FP.69.11 L 119 300.FP.69.13 L 139 300.FP.69.15 L 159 Plexiglass
* N.B.: Per i frontal con lunghezza maggiore o uguale ai 139 cm, ordinare 2 kit di supporti per frontal panel / Note: For frontal panels with a length greater than or equal to 139 cm, order 2 kits of clamps-supports for frontal panels	

Frontal panels con morsetti e supporti integrati /Frontal panels with clamps and conic clamps

P 4 x H 59	L 77 P 1 x H 39	L 77 P 1 x H 39
300.FR.07.14 L 140 300.FR.07.16 L 160 Per piani/For worktops	300.FR.19.07 Per piani melaminico /For worktops melamine	300.FR.19.07 Per piani melaminico /For worktops melamine
⊗ In caso di BENCH, controllare lo spazio disponibile tra una gamba e l'altra /In the case of BENCH, verify the useful gap between a leg and the next one		

Fontal panels H 65 con supporto freestanding integrato /Frontal panels with freestanding bracket integrated

L 77 P 18 x H 65	L 77 P 18 x H 65	L 77 P 18 x H 65	L 77 P 18 x H 65
300.FR.20.07 Melaminico / Melamine	300.FR.21.07 Plexiglass	300.FR.20.07 Melaminico / Melamine	300.FR.21.07 Plexiglass

Accessori per frontal panels in melaminico/Accessories for melamine frontal panels

L 6,5 P 6,5 x H 8,5	L 50 P 17 x H 3	L 31 P 22 x H 5	L 23 P 10 x H 29	L 35 P 6,5 x H 30
300.FA.01.01	300.FA.02.05	300.FA.04.03	300.FA.06.02	300.FA.08.03

Note: Il posizionamento degli accessori sui frontal panel in vetro prevede l'utilizzo di una guarnizione in PVC trasparente (Optional su richiesta)/Placement of accessories on glass front panel need the use of a transparent PVC gasket (Optional on request)
Non utilizzabile su frontal panels in plexiglass e frontal panels in tessuto fonosorbente /Not usable for plexiglass frontal panels and acoustic frontal panels

Note:

1 Le dimensioni sono espresse in cm – consultare il listino prezzi per le caratteristiche tecniche, i codici degli articoli e delle finiture/Dimensions are stated in cm – for technical characteristics, article code numbers and finishing see price list;

■ Prodotti non in pronta consegna. Per la disponibilità contattare l'ufficio commerciale/Items not in prompt delivery. Please contact the commercial department to check availability;
R Con piani con angoli raggiati/With tops with rounded corners;
S Con piani con angoli a spigolo/With tops with sharp corners;

A Morsetti o supporti in ABS /ABS clamps
Z Morsetti o supporti in ZAMA / Zamak clamps
V Vetro/Glass. P Plexiglass

Accessori su binari/Accessories on rail

L 60 P 30 x H 1,8	L 60 P 30 x H 26,5
804.AB.03.06	804.AB.04.06
	804.AB.01.00 Supporti per lampade/Lamp supports

Accessori/Accessories

300.AC.16.02	300.AC.06.05	804.AC.02.02 P 65	804.AC.02.13 P 136,5	804.AC.03.02 P 80 - 100 - 158 - 166,5

Canalizzazione – Elettrificazione – Accessori/Wire management – Electrification – Accessories

804.AP.08.06	300.AP.V1.00	300.AP.F1.00	300.AP.T7.01 Ø 6 300.AP.T8.01 Ø 8	300.AP.T2.01 Ø 8

804.CL.02.01 L 10 804.CL.02.04 L 45 804.CL.02.06 L 65 804.CL.02.08 L 85 804.CL.02.11 L 110	804.AP.01.14 L 140 804.AP.01.16 L 160	804.AP.02.14 L 140 804.AP.02.16 L 160	804.AP.04.01	804.AP.03.01	804.KS.02.00 Per P/For D 136,6 - 166,5
N.B.: Per l'integrazione consultare il relativo listino /NOTES: Check the correspondent price list for the integration					

300.AC.26.02 L 24,5 300.AC.26.03 L 34,5 300.AC.26.04 L 44,5	300.AC.38.02_H 2,4	300.AC.67.03 Marsupio per top access 300.AC.36... 300.AC.38... / Basket for top access 300.AC.36... 300.AC.38...	300.AP.S1.02 L 20,5 300.AP.S1.03 L 30 300.AP.S1.04 L 42 Per/For top access 300.AC.26...	300.AT.A6.02 L 21 300.AT.A6.03 L 25,5 300.AT.A6.04 L 39	300.APT4.01 300.APT5.01 - UK 300.APT6.01 - US	300.AP.T8.11 300.AP.T8.14 300.AP.T8.17 300.AP.T8.20

Bracci porta video/Arms for video support

300.AC.04.01 Braccio porta video mobile su piano /Dynamic arm for video support on deskbase	300.AC.04.02 Doppio braccio porta video mobile su piano/2 dynamic arms for video support on deskbase	300.AC.03.01 Braccio porta video statico su palo /Static arm for video support on pole	300.AC.03.02 Doppio braccio porta video statico su palo/2 static arms for video support on pole	300.AC.02.01 Braccio porta video mobile su piano /Dynamic arm for video support on deskbase	300.AC.02.02 Doppio braccio porta video mobile su piano/2 dynamic arms for video support on deskbase
300.AC.01.01 Braccio porta video statico su palo/Static arm for video support on pole	300.AC.01.02 Doppio braccio porta video statico su palo/2 static arms for video support on pole				

Note:

1 Le dimensioni sono espresse in cm – consultare il listino prezzi per le caratteristiche tecniche, i codici degli articoli e delle finiture/Dimensions are stated in cm – for technical characteristics, article code numbers and finishing see price list;
2 Per la scelta dei contenitori e degli accessori vari, consultare il relativo listino o catalogo/To choose storage units and accessories, please check correspondent price list or catalogue;

■ Articoli prodotti solo su richiesta/Items produced only on demand;
■ Prodotti non in pronta consegna. Per la disponibilità contattare l'ufficio commerciale/Items not in prompt delivery. Please contact the commercial department to check availability;

⊗ Fino ad esaurimento/Until exhaustion;

DV801 Entity

Design:
Antonio Morello

Comp. N°1

IT Arredare con gusto e funzionalità – Linea operativa che si distingue per la sua particolare essenzialità e semplicità. Attuale nei concetti fondamentali del lavoro in ufficio, estremamente funzionale nelle postazioni di lavoro condivise. Semplici concetti: elementi aggregabili creano composizioni base di forte rigore funzionale riducendo i componenti, semplificando le forme e la logica compositiva.

EN Furnishing with taste and functionality – This workstation range stands out for its essentiality and simplicity. Up to date with the fundamental concepts of today's office, extremely functional in shared workstation solutions. Simple concepts: combinable elements create compositions based on strong functionality by reducing components, simplifying form and using compositional logic.







DV801 Entity

Design:
Antonio Morello

Comp. N°2

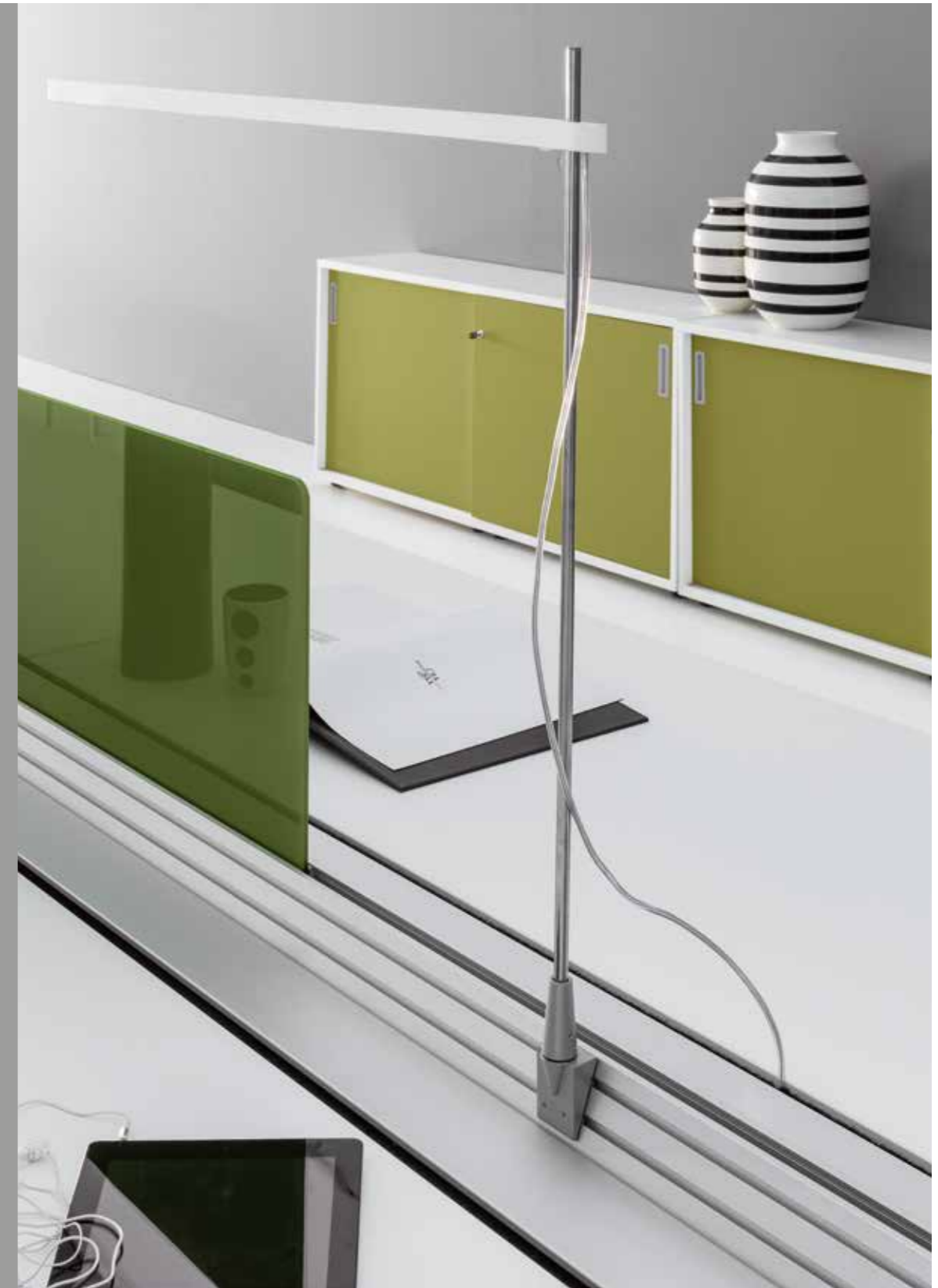







DV801 Entity

Design:
Antonio Morello

Comp. N°3







DV801 Entity

Design:
Antonio Morello

Comp. N°4













DV801 Entity

Design:
Antonio Morello

Comp. N°5









DV801 Entity

Design:
Antonio Morello

Comp. N°6









Tavoli/Tables

Piani di lavoro sp. 1.8 cm, in melaminico con bordi in ABS sp. 0.2 cm/Worktops 1.8 cm thick, in melamine with ABS edge-profiles 0.2 cm thick



Piani di lavoro sp. 1 cm, in vetro temprato retrolaccato acidato con bordi perimetrali lavorati a filo lucido / Worktops 1 cm thick, rear-lacquered and acetated tempered glass with outer polished edges



Strutture metalliche/Metal structures



Modesty panel

Modesty panel sp. 1.8 cm, in melaminico/Modesty panel 1.8 cm thick, in melamine



Mobili di servizio/Service units

Scocca e ripiani sp. 1.8 cm, in melaminico/Bodies and shelves 1.8 cm thick, in melamine

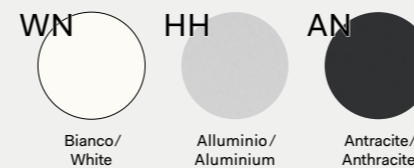

Ante scorrevoli sp. 1.8 cm, in melaminico con bordo ABS sp. 0.15 cm colore alluminio/Sliding doors 1.8 cm thick, in melamine with aluminium-coloured ABS edge-profiles 0.15 cm thick

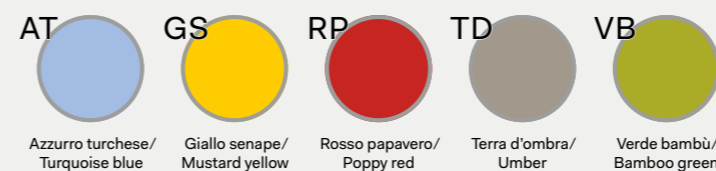

Ante scorrevoli sp. 1.8 cm, in melaminico con bordo ABS sp. 0.15 cm in tinta/Sliding doors 1.8 cm thick, in melamine with ABS edge-profiles 0.15 cm thick, in same color



Note

Per i colori e le finiture dei Frontal Panels, vedere il relativo capitolo in DV300 - Accessori. / For colours and finishes of Frontal Panels, see the chapter in DV300 - Accessories.

☒ Prodotti non in pronta consegna. Per la disponibilità contattare l'ufficio commerciale./Items not in prompt delivery. Please contact the commercial department to check availability.

☒ Fino ad esaurimento. / Until exhaustion.

Piani di lavoro in melaminico sp. 18 mm con bordi perimetrali in ABS/Worktops in melamine 23/32" thick with perimetrical edges in ABS

Tavoli scrivania P 65/Desks 65 depth

P 65 x H 74

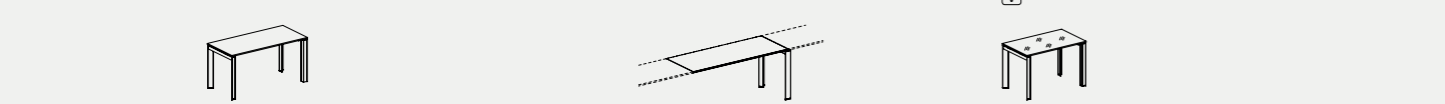

801.TS.01.08_L 80	801.TS.01.16_L 160	801.TS.05.08_L 80	801.TS.05.16_L 160	801.TV.01.10_L 100 Vetro/Glass
801.TS.01.10_L 100	801.TS.01.18_L 180	801.TS.05.10_L 100	801.TS.05.18_L 180	
801.TS.01.12_L 120	801.TS.01.20_L 200	801.TS.05.12_L 120	801.TS.05.20_L 200	
801.TS.01.14_L 140		801.TS.05.14_L 140		

Tavoli scrivania P 80/Desks 80 depth

P 80 x H 74

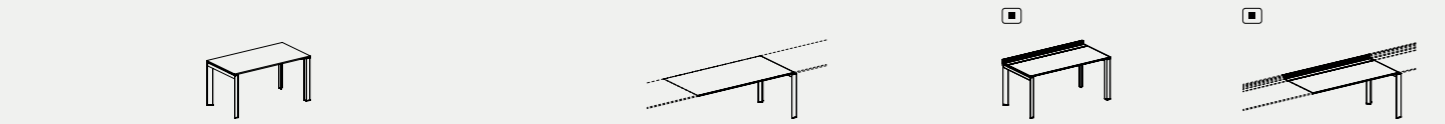

801.TS.02.08_L 80	801.TS.02.16_L 160	801.TS.06.08_L 80	801.TS.06.16_L 160	801.TS.43.14_L 140	801.TS.63.14_L 140
801.TS.02.10_L 100	801.TS.02.18_L 180	801.TS.06.10_L 100	801.TS.06.18_L 180	801.TS.43.16_L 160	801.TS.63.16_L 160
801.TS.02.12_L 120	801.TS.02.20_L 200	801.TS.06.12_L 120	801.TS.06.20_L 200		
801.TS.02.14_L 140		801.TS.06.14_L 140			

Tavoli executive P 90/90 depth executive tables

P 90 x H 74

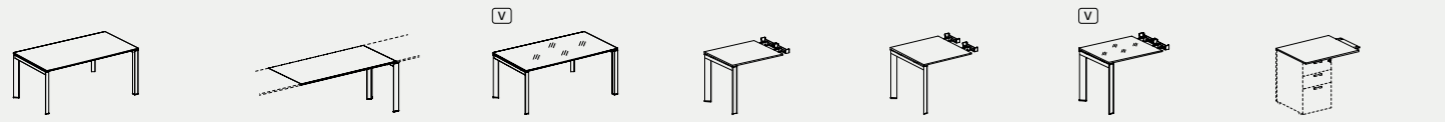

801.TS.03.18_L 80	801.TS.07.18_L 180	801.TV.03.18_L 180 Vetro/Glass	801.TD.01.08_L 80	801.TD.02.08_L 80	801.DV.01.10_L 100 Vetro/Glass	801.AL.01.08_L 80	801.AL.01.10_L 100	801.AL.01.12_L 120
801.TS.03.20_L 200	801.TS.07.20_L 200	801.TV.03.20_L 200	801.TD.01.10_L 100	801.TD.02.10_L 100		801.AL.01.10_L 100		

Allunghi laterali/Lateral extensions

P 65 x H 74 P 80 x H 74 P 65 x H 74 P 65 x H 1,8

Tavoli scrivania P 136,5/Desks 136,5 depth

P 136,5 x H 74

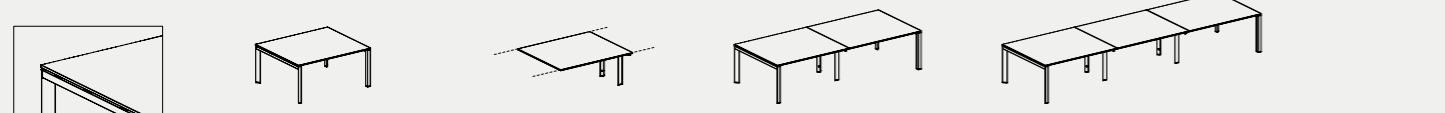

801.TS.37.14_L 140	801.TS.38.14_L 140	801.TS.37.28_L 280	801.TS.37.42_L 420
801.TS.37.16_L 160	801.TS.38.16_L 160	801.TS.37.32_L 320	801.TS.37.48_L 480
801.TS.37.18_L 180	801.TS.38.18_L 180	801.TS.37.36_L 360	801.TS.37.54_L 540

Tavoli P 136,5 a 2 scrivanie contrapposte/Benches 136,5 depth

P 136,5 x H 74



801.TB.01.08_L 80	801.TB.11.08_L 80	801.FB.01.16_L 160	801.SB.01.24_L 240
801.TB.01.10_L 100	801.TB.11.10_L 100	801.FB.01.20_L 200	801.SB.01.30_L 300
801.TB.01.12_L 120	801.TB.11.12_L 120	801.FB.01.24_L 240	801.SB.01.36_L 360
801.TB.01.14_L 140	801.TB.11.14_L 140	801.FB.01.28_L 280	801.SB.01.42_L 420
801.TB.01.16_L 160	801.TB.11.16_L 160	801.FB.01.32_L 320	801.SB.01.48_L 480
801.TB.01.18_L 180	801.TB.11.18_L 180	801.FB.01.36_L 360	801.SB.01.54_L 540
801.TB.01.20_L 200	801.TB.11.20_L 200	801.FB.01.40_L 400	801.SB.01.60_L 600

Tavoli P 136,5 a 2 scrivanie contrapposte + binario centrale/Benches 136,5 depth + central rail

P 136,5 x H 74

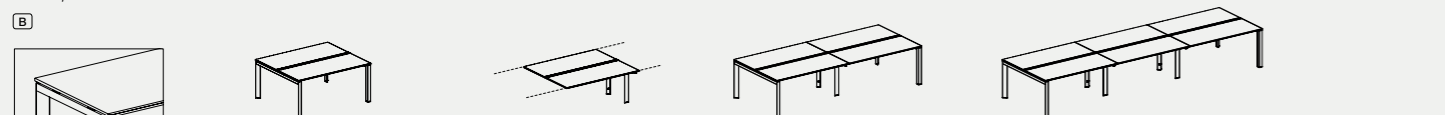

801.TB.03.08_L 80	801.TB.13.08_L 80	801.FB.03.16_L 160	801.SB.03.24_L 240
801.TB.03.10_L 100	801.TB.13.10_L 100	801.FB.03.20_L 200	801.SB.03.30_L 300
801.TB.03.12_L 120	801.TB.13.12_L 120	801.FB.03.24_L 240	801.SB.03.36_L 360
801.TB.03.14_L 140	801.TB.13.14_L 140	801.FB.03.28_L 280	801.SB.03.42_L 420
801.TB.03.16_L 160	801.TB.13.16_L 160	801.FB.03.32_L 320	801.SB.03.48_L 480
801.TB.03.18_L 180	801.TB.13.18_L 180	801.FB.03.36_L 360	801.SB.03.54_L 540
801.TB.03.20_L 200	801.TB.13.20_L 200	801.FB.03.40_L 400	801.SB.03.60_L 600

Piani di lavoro in melaminico sp. 18 mm con bordi perimetrali in ABS/Worktops in melamine 23/32" thick with perimetrical edges in ABS

Tavoli P 158 a 2 scrivanie contrapposte con profilo doppio attrezzabile/Benches 158 depth with double accessory profile

P 158 x H 74



801.TB.22.08_L 80	801.TB.26.08_L 80	801.FB.22.16_L 160	801.SB.22.24_L 240
801.TB.22.10_L 100	801.TB.26.10_L 100	801.FB.22.20_L 200	801.SB.22.30_L 300
801.TB.22.12_L 120	801.TB.26.12_L 120	801.FB.22.24_L 240	801.SB.22.36_L 360
801.TB.22.14_L 140	801.TB.26.14_L 140	801.FB.22.28_L 280	801.SB.22.42_L 420
801.TB.22.16_L 160	801.TB.26.16_L 160	801.FB.22.32_L 320	801.SB.22.48_L 480
801.TB.22.18_L 180	801.TB.26.18_L 180	801.FB.22.36_L 360	801.SB.22.54_L 540
801.TB.22.20_L 200	801.TB.26.20_L 200	801.FB.22.40_L 400	801.SB.22.60_L 600

Tavoli P 158 a 2 scrivanie contrapposte + binario centrale con 2 sportelli/Benches 158 depth + central rail with 2 flip-up covers

P 158 x H 74



801.TB.23.08_L 80	801.TB.27.08_L 80	801.FB.23.16_L 160	801.SB.23.24_L 240
801.TB.23.10_L 100	801.TB.27.10_L 100	801.FB.23.20_L 200	801.SB.23.30_L 300
801.TB.23.12_L 120	801.TB.27.12_L 120	801.FB.23.24_L 240	801.SB.23.36_L 360
801.TB.23.14_L 140	801.TB.27.14_L 140	801.FB.23.28_L 280	801.SB.23.42_L 420
801.TB.23.16_L 160	801.TB.27.16_L 160	801.FB.23.32_L 320	801.SB.23.48_L 480
801.TB.23.18_L 180	801.TB.27.18_L 180	801.FB.23.36_L 360	801.SB.23.54_L 540
801.TB.23.20_L 200	801.TB.27.20_L 200	801.FB.23.40_L 400	801.SB.23.60_L 600

Tavoli scrivania doppia P 158 con asole e 2 top access/Benches 158 depth with opening and 2 top access

P 158 x H 74

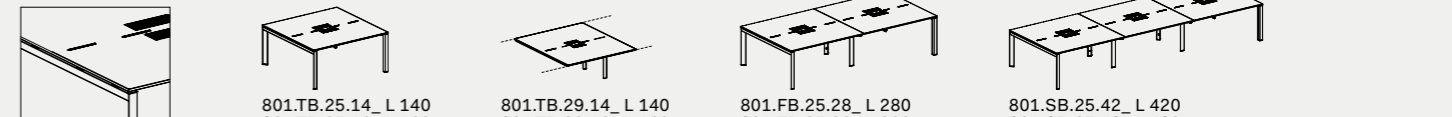

801.TB.25.14_L 140	801.TB.29.14_L 140	801.FB.25.28_L 280	801.SB.25.42_L 420
801.TB.25.16_L 160	801.TB.29.16_L 160	801.FB.25.32_L 320	801.SB.25.48_L 480
801.TB.25.18_L 180	801.TB.29.18_L 180	801.FB.25.36_L 360	801.SB.25.54_L 540

Tavoli P 166,5 a 2 scrivanie contrapposte/Benches 166,5 depth

P 166,5 x H 74

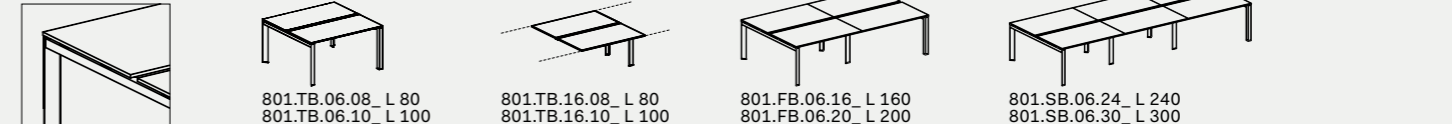

801.TB.06.08_L 80	801.TB.16.08_L 80	801.FB.06.16_L 160	801.SB.06.24_L 240
801.TB.06.10_L 100	801.TB.16.10_L 100	801.FB.06.20_L 200	801.SB.06.30_L 300
801.TB.06.12_L 120	801.TB.16.12_L 120	801.FB.06.24_L 240	801.SB.06.36_L 360
801.TB.06.14_L 140	801.TB.16.14_L 140	801.FB.06.28_L 280	801.SB.06.42_L 420
801.TB.06.16_L 160	801.TB.16.16_L 160	801.FB.06.32_L 320	801.SB.06.48_L 480
801.TB.06.18_L 180	801.TB.16.18_L 180	801.FB.06.36_L 360	801.SB.06.54_L 540
801.TB.06.20_L 200	801.TB.16.20_L 200	801.FB.06.40_L 400	801.SB.06.60_L 600

Tavoli P 166,5 a 2 scrivanie contrapposte + binario centrale/Benches 166,5 depth + central rail

P 166,5 x H 74

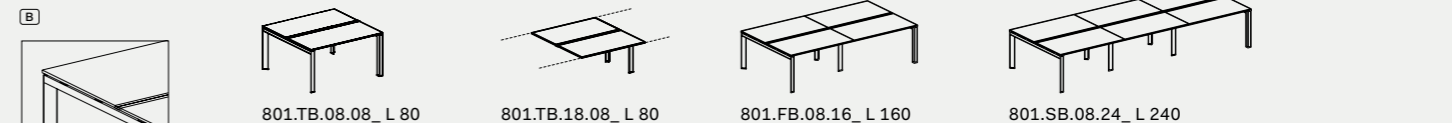

801.TB.08.08_L 80	801.TB.18.08_L 80	801.FB.08.16_L 160	801.SB.08.24_L 240
801.TB.08.10_L 100	801.TB.18.10_L 100	801.FB.08.20_L 200	801.SB.08.30_L 300
801.TB.08.12_L 120	801.TB.18.12_L 120	801.FB.08.24_L 240	801.SB.08.36_L 360
801.TB.08.14_L 140	801.TB.18.14_L 140	801.FB.08.28_L 280	801.SB.08.42_L 420
801.TB.08.16_L 160	801.TB.18.16_L 160	801.FB.08.32_L 320	801.SB.08.48_L 480
801.TB.08.18_L 180	801.TB.18.18_L 180	801.FB.08.36_L 360	801.SB.08.54_L 540
801.TB.08.20_L 200	801.TB.18.20_L 200	801.FB.08.40_L 400	801.SB.08.60_L 600

Tavolo riunioni/Conference tables

P 120 x H 74



801.TR.40.24_L 240

Componenti per tavoli/Components for desks

P 65 x H 1,8 P 80 x H 1,8

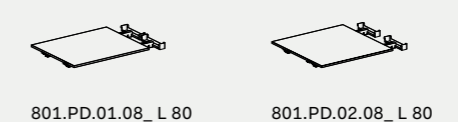

801.PD.01.08_L 80
801.PD.01.10_L 100
801.PD.01.12_L 120

801.PD.02.08_L 80
801.PD.02.10_L 100
801.PD.02.12_L 120

Piani terminali/Terminal tops

P 40 x H 1,8 P 65 x H 74

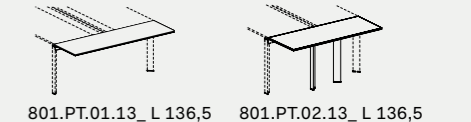

801.PT.01.13_L 136,5
801.PT.01.15_L 158
801.PT.01.16_L 166,5

801.PT.02.13_L 136,5
801.PT.02.15_L 158
801.PT.02.16_L 166,5

Note:

Le dimensioni sono espresse in cm - consultare il listino prezzi per le caratteristiche tecniche, i codici degli articoli e delle finiture/Dimensions are stated in cm - for technical characteristics, article code numbers and finishing see price list;

Prodotti non in pronta consegna. Per la disponibilità contattare l'ufficio commerciale/Items not in prompt delivery. Please contact the commercial department to check availability;

Con binario centrale/With central rail;
Vetro/Glass.

Piani di lavoro in melaminico sp. 18 mm con bordi perimetrali in ABS/Worktops in melamine 23/32" thick with perimetrical edges in ABS

Cassettiere portanti/Carrying pedestals

L 42 P 65 x H 71,5
 H 1,8
 550.CG.13.04_ Top
 H 2,5
 550.CG.11.04 Zoccolo (Optional) /Base frame (Optional)
 801.CG.07.00

550.CS.30.04_ 550.CS.40.04_

Contenitori H 74/Storage units H 74

L 80 P 33 x 71,5
 H 1,8
 550.CG.13.08_ Top
 H 2,5
 550.CG.11.08 Zoccolo (Optional) /Base frame (Optional)

550.CC.02.08_ Con ante/With doors

Cassettiere/Pedestals

L 42 P 57 x H 55,5
 L 32,2 P 54,2 x H 55,5
 L 42,2 P 54,2 x H 55,5
 L 33 P 53 x H 44
 L 32,5 P 52 x H 14,5

550.CS.10.04_ Melaminico/Melamine
 550.CS.20.04_ Melaminico/Melamine
 550.CS.1M.03_ Metalliche/Metallic
 550.CS.2M.03_ Metalliche/Metallic
 550.CS.1M.04_ Metalliche - Vaschetta porta cancelleria inclusa/Metallic - Stationery tray included
 550.CS.2M.04_ Metalliche - Vaschetta porta cancelleria inclusa/Metallic - Stationery tray included
 801.CS.11.03 Sospesa melaminico /Hanged melamine
 801.CA.01.05 Sospesa metallica /Hanged metallic

Note: La finitura impiallacciato non è in pronta consegna. Per la disponibilità contattare l'ufficio commerciale. Per portacancelleria cassetti, vedi capitolo DV300-Accessori/Veneered finish is not in prompt delivery. Please contact the commercial department to check availability. For stationary tray, see chapter DV300-Accessories

Tavoli integrabili su mobili di servizio/Integrable desks for service units

P 65 x H 74 P 80 x H 74 P 90 x H 74 P 136,5 x H 74

801.TI.01.16_ L 160
 801.TI.01.18_ L 180
 801.TI.01.20_ L 200

801.TI.02.16_ L 160
 801.TI.02.18_ L 180
 801.TI.02.20_ L 200

801.TI.12.18_ L 180
 801.TI.12.20_ L 200

801.TI.03.18_ L 180
 801.TI.03.20_ L 200

801.TI.04.14_ L 140
 801.TI.04.16_ L 160
 801.TI.04.18_ L 180

801.TI.05.16_ L 160
 801.TI.05.18_ L 180
 801.TI.05.20_ L 200

801.TI.06.16_ L 160
 801.TI.06.18_ L 180
 801.TI.06.20_ L 200

P 158 x H 74
 801.TI.13.16_ L 160
 801.TI.13.18_ L 180
 801.TI.13.20_ L 200

801.TI.07.14_ L 140
 801.TI.07.16_ L 160
 801.TI.07.18_ L 180

801.TI.08.16_ L 160
 801.TI.08.18_ L 180
 801.TI.08.20_ L 200

P 166,5 x H 74
 801.TI.10.16_ L 160
 801.TI.10.18_ L 180
 801.TI.10.20_ L 200

801.TI.11.16_ L 160
 801.TI.11.18_ L 180
 801.TI.11.20_ L 200

Mobili di servizio con ante scorrevoli/Service units with sliding doors

L 160 P 48 x H 58 L 160 P 48 x H 58

801.MS.02.16_ Monofacciale/Uniface
 801.MS.01.16_ Bifacciale/Bifacial

Optional 801.CA.01.03
 Optional 503.CS.P1.00
 Optional 503.CS.A5.04

Optional per cod. 801.MS.02.16_ /801.MS.01.16_ /Optional for code 801.MS.02.16_ /801.MS.01.16_

Contenitori terminali con ante scorrevoli /Terminal storage units with sliding doors

P 40 x H 40

801.CT.02.13_ L 136,5
 801.CT.02.15_ L 158
 801.CT.02.16_ L 166,5

801.CT.05.00
 Kit per sovrapposizione contenitori terminali con ante scorrevoli /Kit for stacking terminal storage units with sliding doors

Porta dox/Top box

L 80 P 40 x H 40

300.AC.15.06
 Metallico/Metallic

Note: Le dimensioni sono espresse in cm - consultare il listino prezzi per le caratteristiche tecniche, i codici degli articoli e delle finiture/Dimensions are stated in cm - for technical characteristics, article code numbers and finishing see price list; Prodotti non in pronta consegna. Per la disponibilità contattare l'ufficio commerciale/Items not in prompt delivery. Please contact the commercial department to check availability;

Con binario centrale/With central rail; Vetro/Glass; Con serratura/With lock;

Piani di lavoro in melaminico sp. 18 mm con bordi perimetrali in ABS/Worktops in melamine 23/32" thick with perimetrical edges in ABS

Gambe fisse terminali inclinate/Tilted fix terminal legs

P 5 x H 71 P 5 x H 71

801.GF.01.06_ L 65
 801.GF.01.08_ L 80
 801.GF.01.09_ L 90
 801.GF.01.12_ L 120

801.GF.01.13_ L 136,5
 801.GF.01.15_ L 158
 801.GF.01.16_ L 166,5

801.GF.02.06_ L 65
 801.GF.02.08_ L 80
 801.GF.02.09_ L 90
 801.GF.02.12_ L 120

801.GF.02.13_ L 136,5
 801.GF.02.15_ L 158
 801.GF.02.16_ L 166,5

Gambe fisse intermedie/Fix middle legs

P 5 x H 71

801.GF.03.06_ L 65
 801.GF.03.08_ L 80
 801.GF.03.09_ L 90

801.GF.04.12_ L 120
 801.GF.04.13_ L 136,5
 801.GF.04.15_ L 158
 801.GF.04.16_ L 166,5

801.GC.01.05_ L 120-136,5
 801.GC.01.07_ L 158-166,5

Coppia carter per gambe intermedie/Pair of casings for middle legs

Gambe terminali pannellate/Terminal panelled legs

P 5 x H 71

801.GP.01.06_ L 65
 801.GP.01.08_ L 80
 801.GP.01.09_ L 90

801.GP.01.13_ L 136,5
 801.GP.01.15_ L 158
 801.GP.01.16_ L 166,5

801.GP.02.06_ L 65
 801.GP.02.08_ L 80
 801.GP.02.09_ L 90
 801.GP.02.12_ L 120

801.GP.02.13_ L 136,5
 801.GP.02.15_ L 158
 801.GP.02.16_ L 166,5

Gambe colonna fissa /Fix column leg

L 5 P 5 x H 72,2

801.GF.05.01_

Supporto per M.D.S. 2 Ante scorrevoli /Support for service unit 2 sliding doors

801.KT.01.06_ L 65
 801.KT.01.08_ L 80
 801.KT.01.09_ L 90
 801.KT.01.13_ L 136,5
 801.KT.01.15_ L 158
 801.KT.01.16_ L 166,5

Piani/Worktops

P 65 x H 1,8 P 80 x H 1,8 P 80 x H 1,8 P 90 x H 1,8 P 120 x H 1,8 P 136,5 x H 1,8 P 136,5 x H 1,8

801.PS.01.08_ L 80
 801.PS.01.10_ L 100
 801.PS.01.12_ L 120
 801.PS.01.14_ L 140
 801.PS.01.16_ L 160
 801.PS.01.18_ L 180
 801.PS.01.20_ L 200

801.PS.02.08_ L 80
 801.PS.02.10_ L 100
 801.PS.02.12_ L 120
 801.PS.02.14_ L 140
 801.PS.02.16_ L 160
 801.PS.02.18_ L 180
 801.PS.02.20_ L 200

801.PS.19.14_ L 180
 801.PS.19.16_ L 200

801.PS.03.18_ L 180
 801.PS.03.20_ L 200

801.PS.14.24_ L 240

801.PR.06.14_ L 140
 801.PR.06.16_ L 160
 801.PR.06.18_ L 180

801.PB.01.08_ L 80
 801.PB.01.10_ L 100
 801.PB.01.12_ L 120
 801.PB.01.14_ L 140
 801.PB.01.16_ L 160
 801.PB.01.18_ L 180
 801.PB.01.20_ L 200

P 158 x H 1,8 P 166,5 x H 1,8 P 136,5 x H 1,8 P 166,5 x H 1,8 P 158 x H 1,8 P 158 x H 1,8

801.PB.25.14_ L 140
 801.PB.25.16_ L 160
 801.PB.25.18_ L 180

801.PB.06.08_ L 80
 801.PB.06.10_ L 100
 801.PB.06.12_ L 120
 801.PB.06.14_ L 140
 801.PB.06.16_ L 160
 801.PB.06.18_ L 180
 801.PB.06.20_ L 200

801.PB.03.08_ L 80
 801.PB.03.10_ L 100
 801.PB.03.12_ L 120
 801.PB.03.14_ L 140
 801.PB.03.16_ L 160
 801.PB.03.18_ L 180
 801.PB.03.20_ L 200

801.PB.08.08_ L 80
 801.PB.08.10_ L 100
 801.PB.08.12_ L 120
 801.PB.08.14_ L 140
 801.PB.08.16_ L 160
 801.PB.08.18_ L 180
 801.PB.08.20_ L 200

801.PB.22.08_ L 80
 801.PB.22.10_ L 100
 801.PB.22.12_ L 120
 801.PB.22.14_ L 140
 801.PB.22.16_ L 160
 801.PB.22.18_ L 180
 801.PB.22.20_ L 200

801.PB.23.08_ L 80
 801.PB.23.10_ L 100
 801.PB.23.12_ L 120
 801.PB.23.14_ L 140
 801.PB.23.16_ L 160
 801.PB.23.18_ L 180
 801.PB.23.20_ L 200

Accessori su binari/Accessories on rail

L 60 P 30 x H 1,8 L 60 P 30 x H 26,5

801.AB.03.06 801.AB.05.06 801.AB.07.06 801.AB.04.06 801.AB.06.06 801.AB.01.00 801.AB.01.01 801.AB.02.01

Modesty panels

P 1,8 x H 35 P 5 x H 5,1

801.MP.01.08_ L 80
 801.MP.01.10_ L 100
 801.MP.01.12_ L 120
 801.MP.01.14_ L 140
 801.MP.01.16_ L 160
 801.MP.01.18_ L 180
 801.MP.01.20_ L 200
 Per tavoli/For desks

801.ST.01.65_ L 35,5 P 65
 801.ST.01.80_ L 48,3 P 80
 801.ST.01.90_ L 58,3 P 90

Note: Staffa da aggiungere ai modesty panel per mobili di servizio in base alla profondità del piano di lavoro. Per l'integrazione consultare il relativo listino /Bracket to be added to the modesty panels for service units, depending on worktop's depth. Check the correspondent price list for the integration

Note: Le dimensioni sono espresse in cm - consultare il listino prezzi per le caratteristiche tecniche, i codici degli articoli e delle finiture/Dimensions are stated in cm - for technical characteristics, article code numbers and finishing see price list;

Prodotti non in pronta consegna. Per la disponibilità contattare l'ufficio commerciale/Items not in prompt delivery. Please contact the commercial department to check availability;

Con binario centrale/With central rail;

Morsetti e supporti in ABS per frontal panels Sp. 0,5 - 0,8 - 1 - 3 / ABS clamps for frontal panels T. 0,5 - 0,8 - 1 - 3 ^(A)

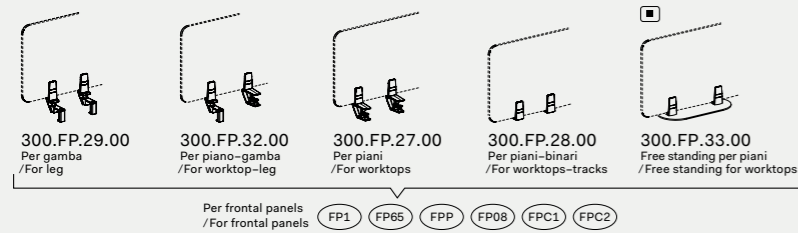

Morsetti e supporti in ZAMA per frontal panels Sp. 0,5 - 0,8 - 1 - 3 / Zamak clamps for frontal panels T. 0,5 - 0,8 - 1 - 3 ^(Z)

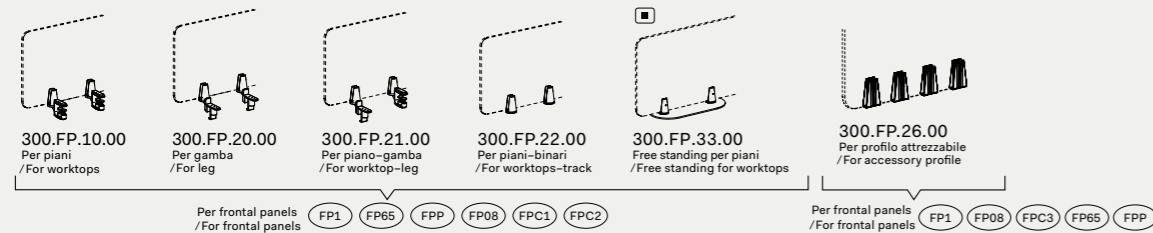

Frontal panels con morsetti e supporti integrati / Frontal panels with clamps and conic clamps

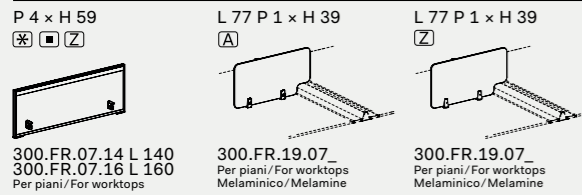

^(Z) In caso di BENCH, controllare lo spazio disponibile tra una gamba e l'altra / In the case of BENCH, verify the useful gap between a leg and the next one

Frontal panels H 65 con supporto freestanding integrato / H 65 frontal panels with freestanding bracket integrated

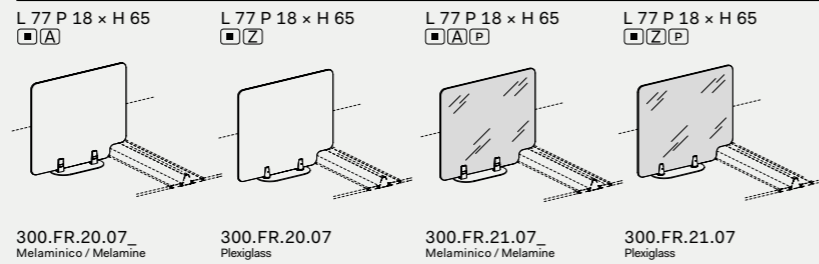

Frontal panels sp. 1 - sp. 0,8

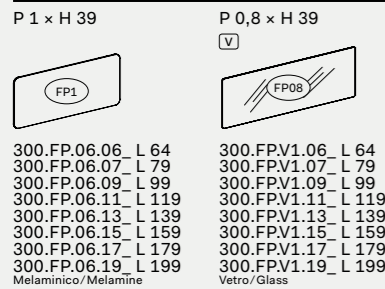

Frontal panel fonoassorbenti sp. 3 / Acoustic frontal panels t. 3

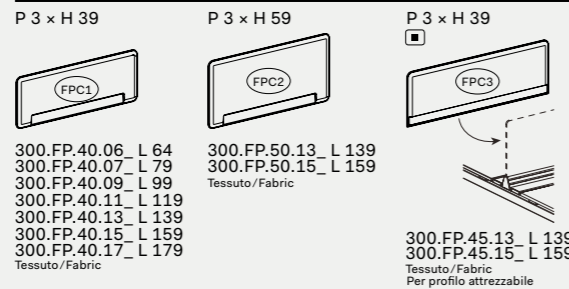

Frontal panels H 65

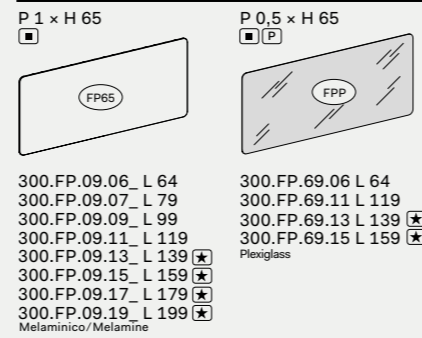

^(★) N.B.: Per i frontal con lunghezza maggiore o uguale ai 139 cm, ordinare 2 kit di supporti per frontal panel / Note: For frontal panels with a length greater than or equal to 139 cm, order 2 kits of clamps-supports for frontal panels

Accessori per frontal panels in melaminico / Accessories for melamine frontal panels

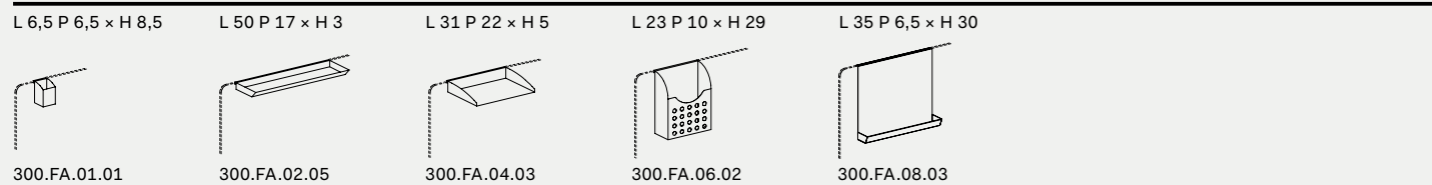

^(Note:) Il posizionamento degli accessori sui frontal panel in vetro prevede l'utilizzo di una guarnizione in PVC trasparente (Optional su richiesta) / Placement of accessories on glass front panel need the use of a transparent PVC gasket (Optional on request)
 Non utilizzabile sui frontal panels in plexiglass e frontal panels in tessuto fonoassorbente / Not usable for plexiglass frontal panels and acoustic frontal panels

Note:

⁽¹⁾ Le dimensioni sono espresse in cm - consultare il listino prezzi per le caratteristiche tecniche, i codici degli articoli e delle finiture / Dimensions are stated in cm - for technical characteristics, article code numbers and finishing see price list;

⁽²⁾ Prodotti non in pronta consegna. Per la disponibilità contattare l'ufficio commerciale / Items not in prompt delivery. Please contact the commercial department to check availability;

^(A) Morsetti o supporti in ABS / ABS clamps
^(Z) Morsetti o supporti in ZAMA / Zamak clamps
^(V) Vetro / Glass.
^(P) Plexiglass

Bracci porta video / Arms for video support

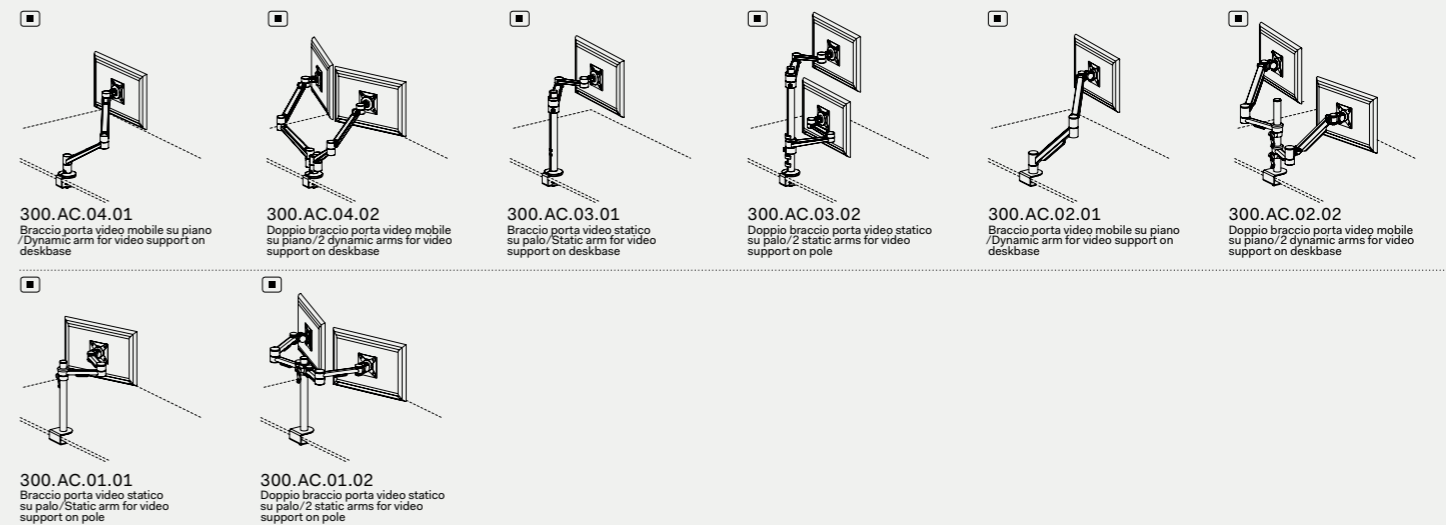

Canalizzazione - Elettrificazione - Accessori / Wire management - Electrification - Accessories

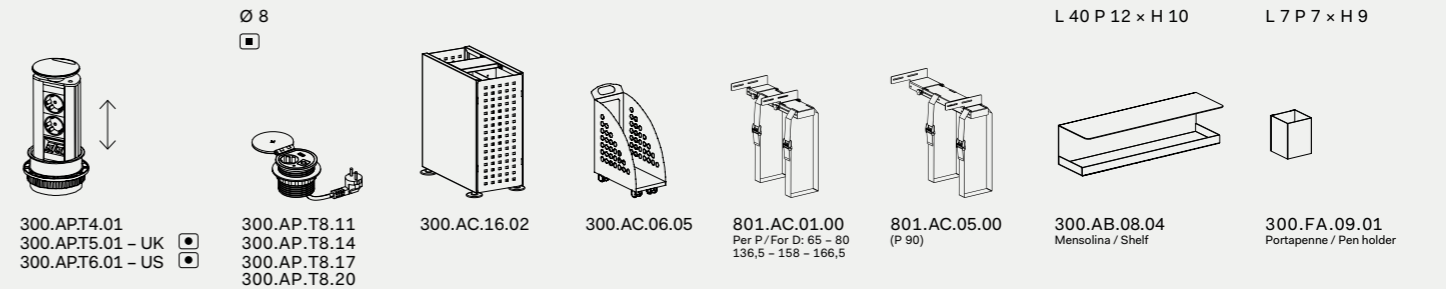
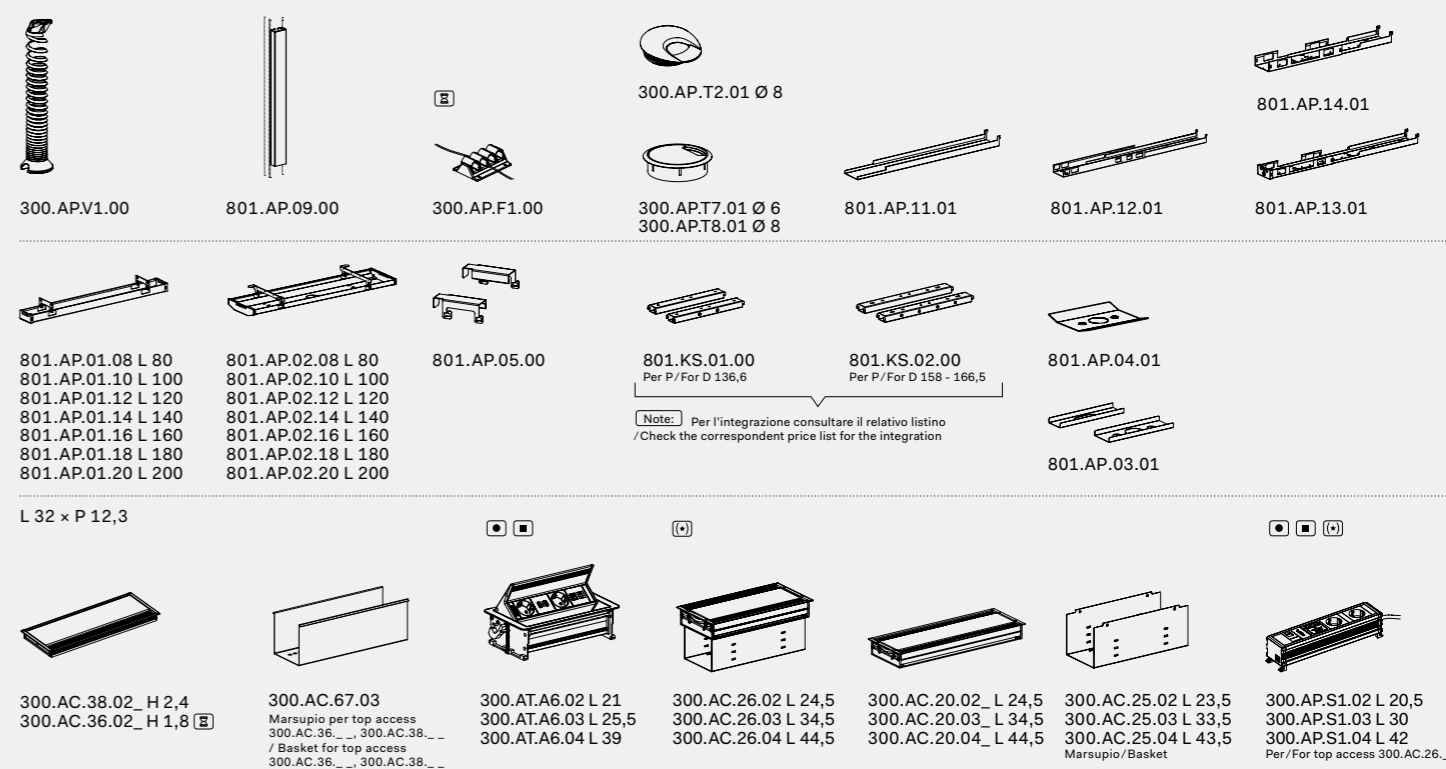

Note:

⁽¹⁾ Le dimensioni sono espresse in cm - consultare il listino prezzi per le caratteristiche tecniche, i codici degli articoli e delle finiture / Dimensions are stated in cm - for technical characteristics, article code numbers and finishing see price list;

⁽²⁾ Per la scelta dei contenitori e degli accessori vari, consultare il relativo listino o catalogo / To choose storage units and accessories, please check correspondent price list or catalogue;

⁽²⁾ Prodotti non in pronta consegna. Per la disponibilità contattare l'ufficio commerciale / Items not in prompt delivery. Please contact the commercial department to check availability;

⁽²⁾ Articoli prodotti solo su richiesta / Items produced only on demand;

^(E) Fino ad esaurimento / Until exhaustion;

IT Sistema modulare flessibile ed elegante – Ci sono collezioni che lasciano una traccia indelebile nell'evoluzione di un'azienda. Questa fa suoi il passato e la tradizione e recupera con artigiana passione il concept dei progetti vincenti. Linee pulite e geometrie semplici sono il filo conduttore di questo sistema ufficio che viene arricchito dalla varietà degli accessori e dalla componente cromatica degli stessi.

EN Flexible and elegant modular system – There are some collections that leave an indelible trace on the evolution of a company. Combination of past and tradition, recovers the concept of winning projects with passionate craftsmanship. Clean line and geometric simplicity are the driving forces of this office system that comes with a variety of accessories and matching colourful components.

































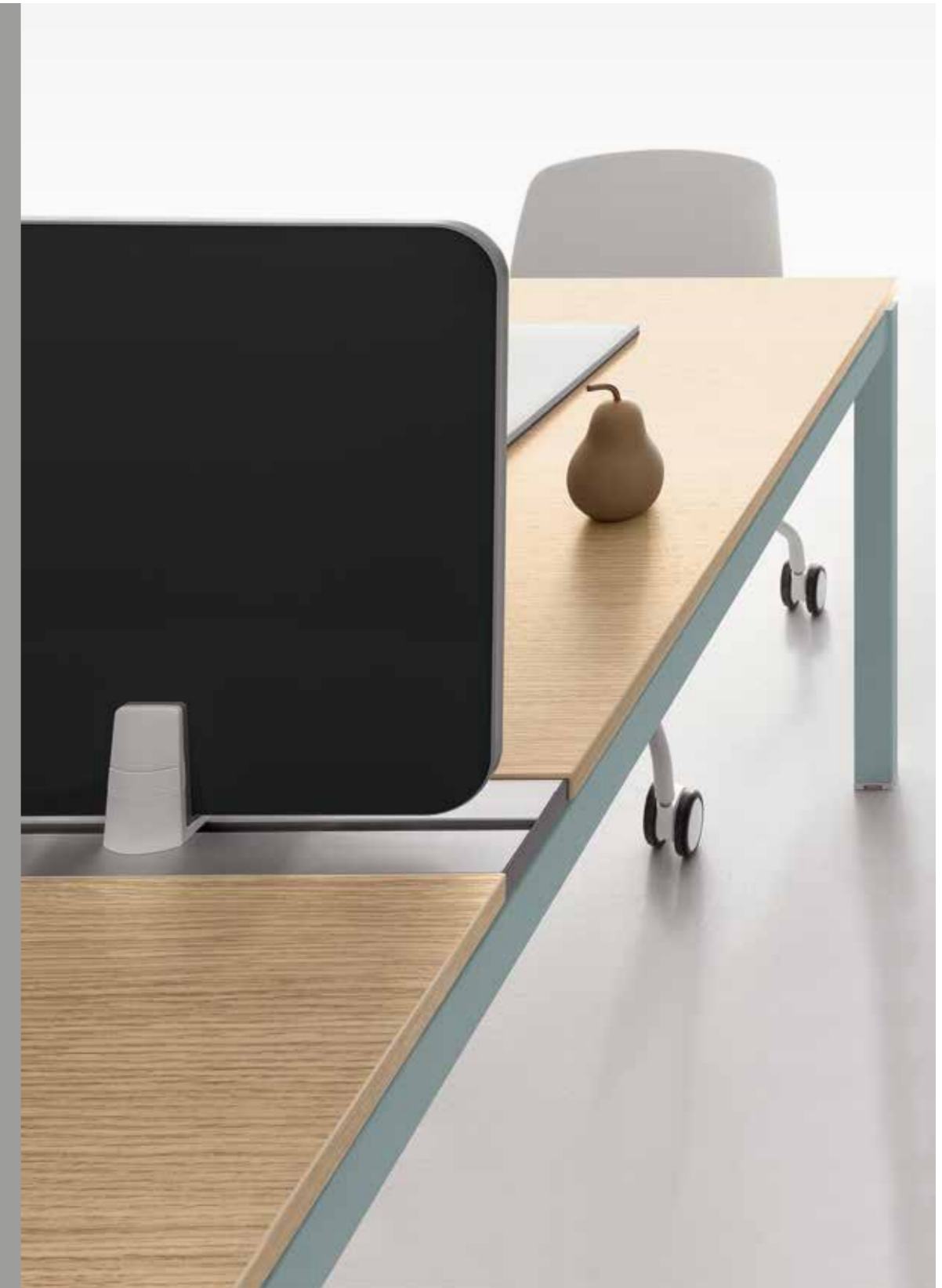

















Tavoli/Tables

Piani di lavoro sp. 1.8 cm, in melaminico con bordi in ABS sp. 0.2 cm/Worktops 1.8 cm thick, in melamine with ABS edge-profiles 0.2 cm thick



Piani di lavoro sp. 1 cm, in vetro temprato retrolaccato acidato con bordi perimetrali lavorati a filo lucido/
Worktops 1 cm thick, rear-lacquered and acetated tempered glass with outer polished edges



Strutture metalliche/Metal structures



Modesty panel

Modesty panel sp. 1.8 cm, in melaminico/Modesty panel 1.8 cm thick, in melamine



Mobili di servizio/Service units

Scocca e ripiani sp. 1.8 cm, in melaminico/Bodies and shelves 1.8 cm thick, in melamine

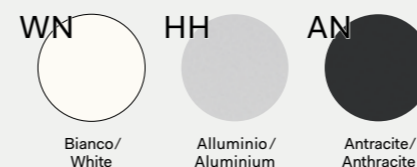

Ante scorrevoli sp. 1.8 cm, in melaminico con bordo ABS sp. 0.15 cm colore alluminio/Sliding doors 1.8 cm thick, in melamine with aluminium-coloured ABS edge-profiles 0.15 cm thick

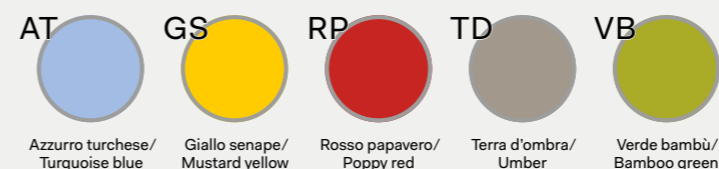

Ante scorrevoli sp. 1.8 cm, in melaminico con bordo ABS sp. 0.15 cm in tinta/Sliding doors 1.8 cm thick, in melamine with ABS edge-profiles 0.15 cm thick, in same color



Note

Per i colori e le finiture dei Frontal Panels, vedere il relativo capitolo in DV300 - Accessori. / For colours and finishes of Frontal Panels, see the chapter in DV300 - Accessories.

Prodotti non in pronta consegna. Per la disponibilità contattare l'ufficio commerciale./Items not in prompt delivery. Please contact the commercial department to check availability.

Fino ad esaurimento. / Until exhaustion.

Piani di lavoro in melaminico sp. 18 mm con bordi perimetrali in ABS/Worktops in melamine 23/32" thick with perimetrical edges in ABS

Tavoli scrivania P 65/Desks 65 depth

P 65 x H 74

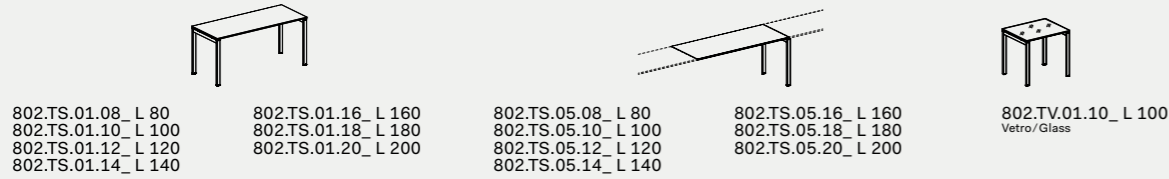

Tavoli scrivania P 80/Desks 80 depth

P 80 x H 74

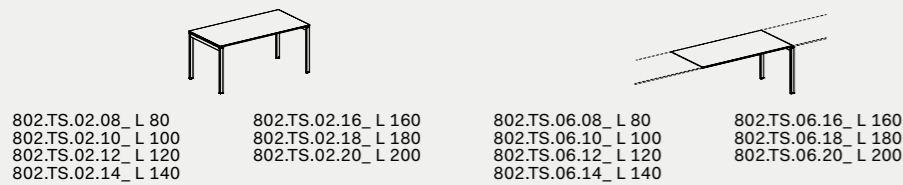

Tavoli executive P 90/90 depth executive tables

P 90 x H 74

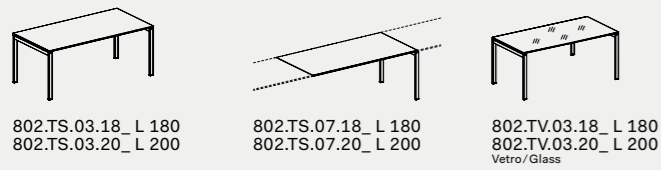

Allunghi laterali/Lateral extensions

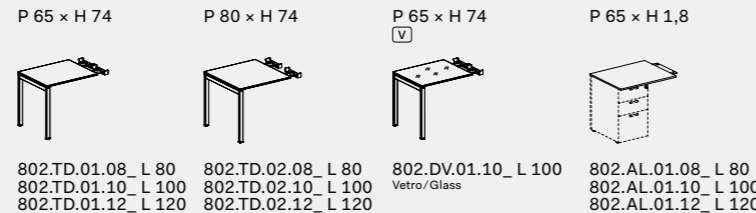

Tavoli scrivania P 136,5/Desks 136,5 depth

P 136,5 x H 74

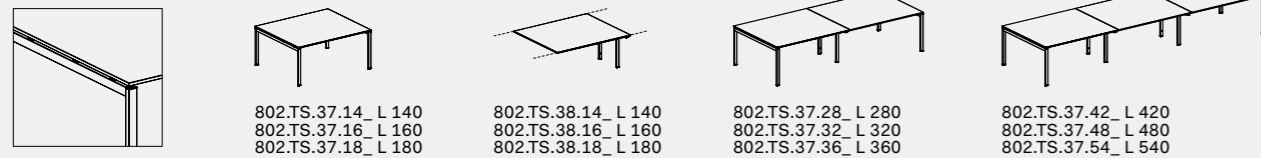

Tavoli P 136,5 a 2 scrivanie contrapposte/Benches 136,5 depth

P 136,5 x H 74

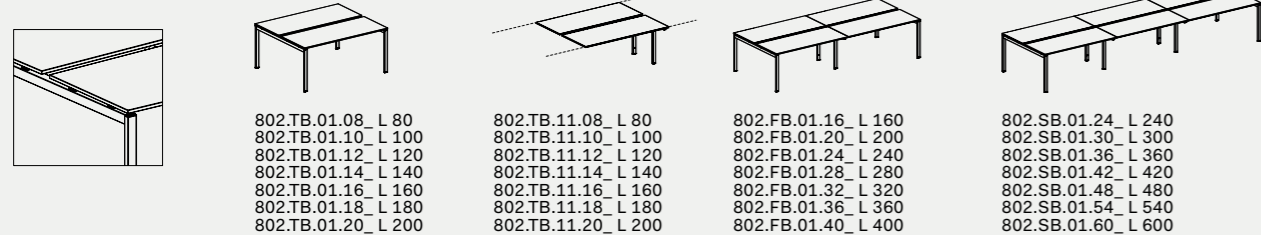

Tavoli P 136,5 a 2 scrivanie contrapposte + binario centrale/Benches 136,5 depth + central rail

P 136,5 x H 74

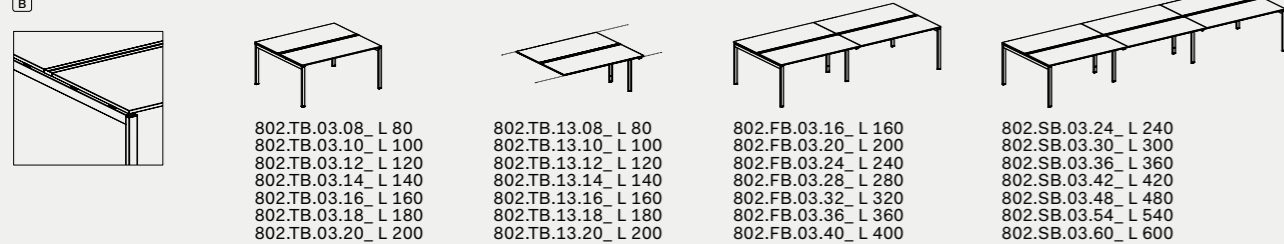

Piani di lavoro in melaminico sp. 18 mm con bordi perimetrali in ABS/Worktops in melamine 23/32" thick with perimetrical edges in ABS

Tavoli P 158 a 2 scrivanie contrapposte + binario centrale con 2 sportelli/Benches 158 depth + central rail with 2 flip-up covers

P 158 x H 74

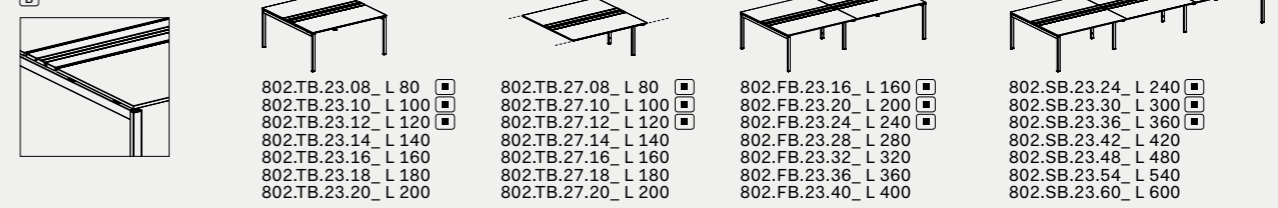

Tavoli scrivania doppia P 158 con asole e 2 top access/Benches 158 depth with opening and 2 top access

P 158 x H 74

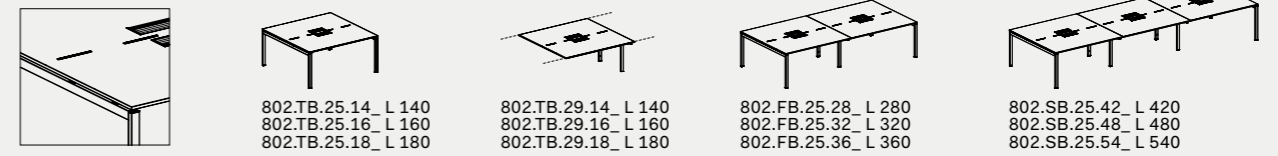

Tavoli P 166,5 a 2 scrivanie contrapposte/Benches 166,5 depth

P 166,5 x H 74

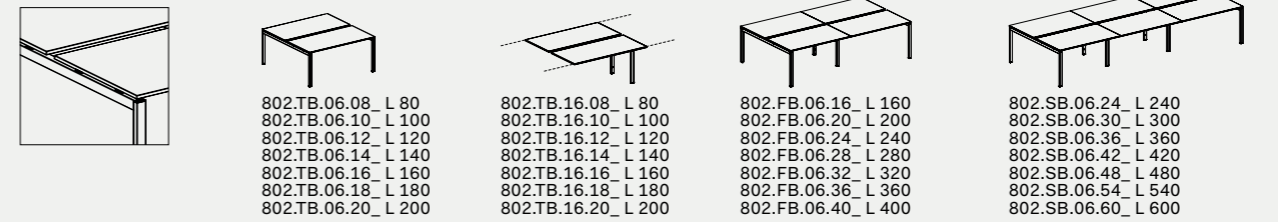

Tavoli P 166,5 a 2 scrivanie contrapposte + binario centrale/Benches 166,5 depth + central rail

P 166,5 x H 74

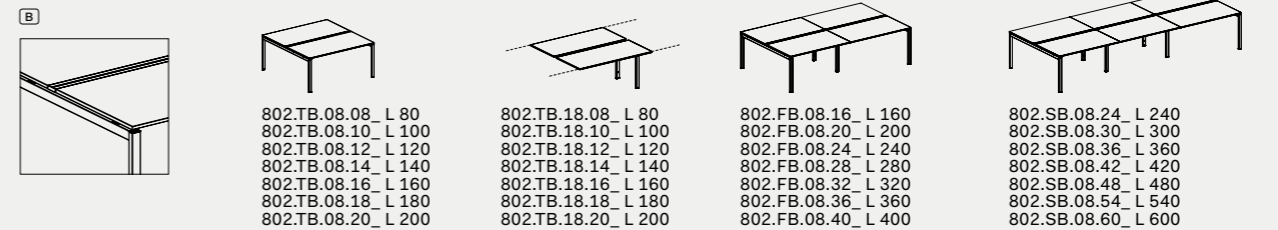

Tavolo riunioni/Conference tables

P 120 x H 74

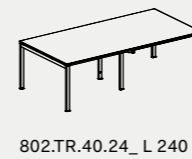

Componenti per tavoli/Components for desks

P 65 x H 1,8

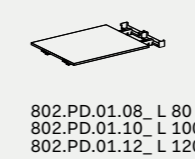

P 80 x H 1,8

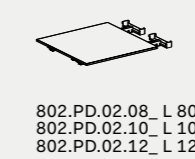

Piani terminali/Terminal tops

P 40 x H 1,8

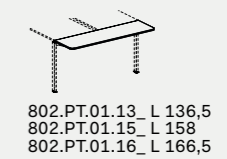

P 65 x H 74

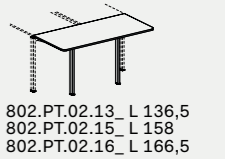

Cassettiere portanti/Carrying pedestals

L 42 P 65 x H 71,5

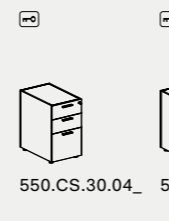

H 1,8

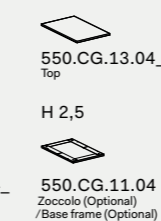

H 2,5

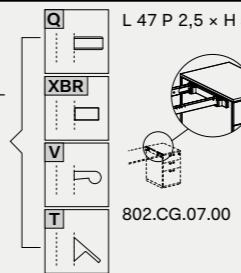

L 47 P 2,5 x H 5

Contenitori H 74/Storage units H 74

L 80 P 33 x 71,5



H 1,8



H 2,5

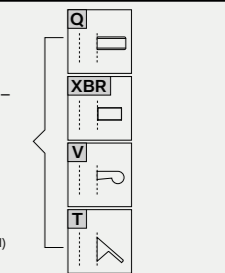

Note:

Le dimensioni sono espresse in cm - consultare il listino prezzi per le caratteristiche tecniche, i codici degli articoli e delle finiture/Dimensions are stated in cm - for technical characteristics, article code numbers and finishing see price list;

Prodotti non in pronta consegna. Per la disponibilità contattare l'ufficio commerciale/items not in prompt delivery. Please contact the commercial department to check availability;

Vetro/Glass.

Con serratura/With lock;

Con binario centrale/With central rail;

Piani di lavoro in melaminico sp. 18 mm con bordi perimetrali in ABS/Worktops in melamine 23/32" thick with perimetrical edges in ABS

Cassettiere/Pedestals

L 42 P 57 x H 55,5		L 32,2 P 54,2 x H 55,5		L 42,2 P 54,2 x H 55,5		L 33 P 53 x H 44		L 32,5 P 52 x H 14,5	
550.CS.10.04 Melaminico/Melamine	550.CS.20.04 Melaminico/Melamine	550.CS.1M.03 Metalliche/Metallic	550.CS.2M.03 Metalliche/Metallic	550.CS.1M.04 Metalliche - Vaschetta porta cancelleria inclusa/Metallic - Stationery tray included	550.CS.2M.04 Metalliche - Vaschetta porta cancelleria inclusa/Metallic - Stationery tray included	802.CS.11.03 Sospesa melaminico /Hanged melamine	802.CA.01.05 Sospesa metallica /Hanged metallic		

Note: La finitura impiallacciato non è in pronta consegna. Per la disponibilità contattare l'ufficio commerciale. Per portacancelleria cassetti, vedi capitolo DV300-Accessori/Veneered finish is not in prompt delivery. Please contact the commercial department to check availability. For stationary tray, see chapter DV300-Accessories

Tavoli integrabili su mobili di servizio/Integrable desks for service units

P 65 x H 74		P 80 x H 74		P 90 x H 74		P 136,5 x H 74	
802.TI.01.16_L 160 802.TI.01.18_L 180 802.TI.01.20_L 200	802.TI.02.16_L 160 802.TI.02.18_L 180 802.TI.02.20_L 200	802.TI.12.18_L 180 802.TI.12.20_L 200	802.TI.03.18_L 180 802.TI.03.20_L 200	802.TI.04.14_L 140 802.TI.04.16_L 160 802.TI.04.18_L 180	802.TI.05.16_L 160 802.TI.05.18_L 180 802.TI.05.20_L 200	802.TI.06.16_L 160 802.TI.06.18_L 180 802.TI.06.20_L 200	802.TI.06.16_L 160 802.TI.06.18_L 180 802.TI.06.20_L 200

Mobili di servizio con ante scorrevoli/Service units with sliding doors

L 160 P 48 x H 58	L 160 P 48 x H 58	Optional 802.CA.01.03	Optional 503.CS.P1.00	Optional 503.CS.A5.04
802.MS.02.16 Monofacciale/Uniface	802.MS.01.16 Bifacciale/Bifacial	Optional per cod. 802.MS.02.16/802.MS.01.16 Optional for code 802.MS.02.16/802.MS.01.16		

Gambe fisse terminali inclinate/Tilted fix terminal legs

P 5 x H 71		P 5 x H 71	
802.GF.01.06_L 65 802.GF.01.08_L 80 802.GF.01.09_L 90 802.GF.01.12_L 120	802.GF.02.06_L 65 802.GF.02.08_L 80 802.GF.02.09_L 90 802.GF.02.12_L 120	802.GF.02.13_L 136,5 802.GF.02.15_L 158 802.GF.02.16_L 166,5	802.GF.02.13_L 136,5 802.GF.02.15_L 158 802.GF.02.16_L 166,5

Gambe regolabili terminali da 65÷86 /Adjustable and terminal legs H min. 65 ÷ max. 86

P 5		P 5	
802.GR.01.06_L 65 802.GR.01.08_L 80 802.GR.01.09_L 90	802.GR.02.06_L 65 802.GR.02.08_L 80 802.GR.02.09_L 90 802.GR.02.12_L 120	802.GR.02.13_L 136,5 802.GR.02.15_L 158 802.GR.02.16_L 166,5	802.GR.02.13_L 136,5 802.GR.02.15_L 158 802.GR.02.16_L 166,5

Note: N.B: Le gambe regolabili non sono utilizzabili su tavoli integrati con mobili di servizio e cassettiere portanti/Height adjustable legs cannot be used on tables supported by service units and carrying pedestals

Note:
 [1] Le dimensioni sono espresse in cm - consultare il listino prezzi per le caratteristiche tecniche, i codici degli articoli e delle finiture/Dimensions are stated in cm - for technical characteristics, article code numbers and finishing see price list;
 [2] Prodotti non in pronta consegna. Per la disponibilità contattare l'ufficio commerciale/Items not in prompt delivery. Please contact the commercial department to check availability;
 [3] Con serratura/With lock;
 [4] Vetro/Glass.
 [5] Con binario centrale/With central rail;

Piani di lavoro in melaminico sp. 18 mm con bordi perimetrali in ABS/Worktops in melamine 23/32" thick with perimetrical edges in ABS

Gambe terminali pannellate/Terminal panelled legs

P 5 x H 72	
802.GP.01.06_L 65 802.GP.01.08_L 80 802.GP.01.09_L 90	802.GP.02.06_L 65 802.GP.02.08_L 80 802.GP.02.09_L 90 802.GP.02.12_L 120

Gambe terminali chiuse/Terminal closed legs

P 5 x H 72	
802.GL.01.06_L 65 802.GL.01.08_L 80 802.GL.01.09_L 90	802.GL.02.06_L 65 802.GL.02.08_L 80 802.GL.02.09_L 90 802.GL.02.12_L 120

Contenitori terminali con ante scorrevoli /Terminal storage units with sliding doors

P 40 x H 40	
802.CT.02.13_L 136,5 802.CT.02.15_L 158 802.CT.02.16_L 166,5	802.CT.05.00 Kit per sovrapposizione contenitori terminali con ante scorrevoli/Kit for stacking terminal storage units with sliding doors

Gamba colonna fissa /Fix column leg

L 5 P 5 x H 71
802.GF.05.01_

Supporto per M.D.S. 2 Ante scorrevoli /Support for service unit 2 sliding doors

802.KT.01.06_L 65 802.KT.01.08_L 80 802.KT.01.09_L 90 802.KT.01.13_L 136,5 802.KT.01.15_L 158 802.KT.01.16_L 166,5

Piani/Worktops

P 65 x H 1,8	P 80 x H 1,8	P 90 x H 1,8	P 120 x H 1,8	P 136,5 x H 1,8	P 136,5 x H 1,8	P 166,5 x H 1,8
802.PS.01.08_L 80 802.PS.01.10_L 100 802.PS.01.12_L 120 802.PS.01.14_L 140 802.PS.01.16_L 160 802.PS.01.18_L 180 802.PS.01.20_L 200	802.PS.02.08_L 80 802.PS.02.10_L 100 802.PS.02.12_L 120 802.PS.02.14_L 140 802.PS.02.16_L 160 802.PS.02.18_L 180 802.PS.02.20_L 200	802.PS.03.18_L 180 802.PS.03.20_L 200	802.PS.14.24_L 240	802.PR.06.14_L 140 802.PR.06.16_L 160 802.PR.06.18_L 180	802.PB.01.08_L 80 802.PB.01.10_L 100 802.PB.01.12_L 120 802.PB.01.14_L 140 802.PB.01.16_L 160 802.PB.01.18_L 180 802.PB.01.20_L 200	802.PB.06.08_L 80 802.PB.06.10_L 100 802.PB.06.12_L 120 802.PB.06.14_L 140 802.PB.06.16_L 160 802.PB.06.18_L 180 802.PB.06.20_L 200

Accessori su binari/Accessories on rail

L 60 P 30 x H 1,8	L 60 P 30 x H 26,5
802.AB.03.06	802.AB.04.06

Porta dox/Top box

L80 P 40 x H 40
300.AC.15.06 Metallico/Metallic

Modesty panels

P 1,8 x H35	P 5 x H 5,1
802.MP.01.08_L 80 802.MP.01.10_L 100 802.MP.01.12_L 120 802.MP.01.14_L 140 802.MP.01.16_L 160 802.MP.01.18_L 180 802.MP.01.20_L 200 Per tavoli/For desks	802.ST.01.65_L 35,5 [2] 65 802.ST.01.80_L 48,3 [2] 80 802.ST.01.90_L 58,3 [2] 90 [Note: Staffa da aggiungere ai modesty panel per mobili di servizio in base alla profondità del piano di lavoro. Per l'integrazione consultare il relativo listino/Bracket to be added to the modesty panels for service units, depending on worktop's depth. Check the correspondent price list for the integration

Note:
 [1] Le dimensioni sono espresse in cm - consultare il listino prezzi per le caratteristiche tecniche, i codici degli articoli e delle finiture/Dimensions are stated in cm - for technical characteristics, article code numbers and finishing see price list;
 [2] Prodotti non in pronta consegna. Per la disponibilità contattare l'ufficio commerciale/Items not in prompt delivery. Please contact the commercial department to check availability;
 [3] Con serratura/With lock;
 [4] Con binario centrale/With central rail;

Morsetti e supporti in ABS per frontal panels Sp. 0,5 - 0,8 - 1 - 3 / ABS clamps for frontal panels T. 0,5 - 0,8 - 1 - 3 ^(A)

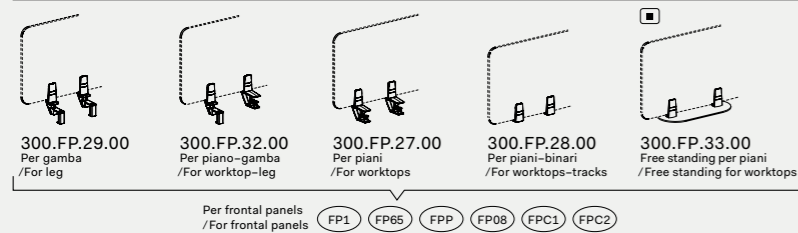

Morsetti e supporti in ZAMA per frontal panels Sp. 0,5 - 0,8 - 1 - 3 / Zamak clamps for frontal panels T. 0,5 - 0,8 - 1 - 3 ^(Z)

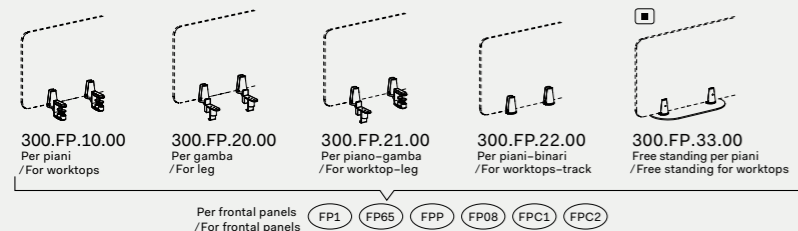

Frontal panels con morsetti e supporti integrati / Frontal panels with clamps and conic clamps

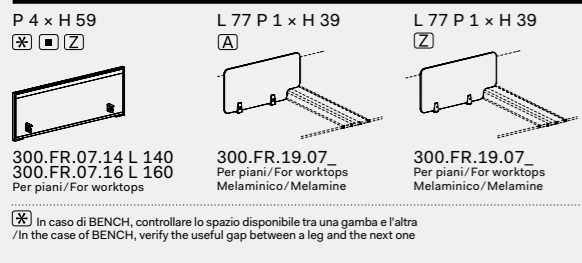

Frontal panels H 65 con supporto freestanding integrato / Frontal panels with freestanding bracket integrated

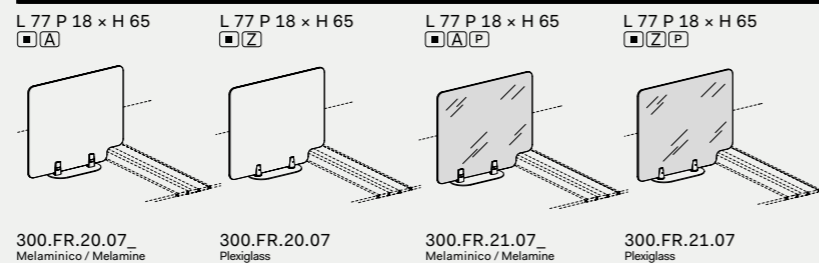

Frontal panels sp. 1 - sp. 0,8

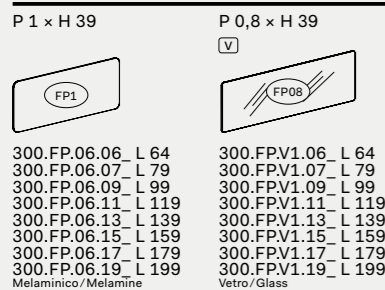

Frontal panel fonoassorbenti sp. 3 / Acoustic frontals panels t. 3

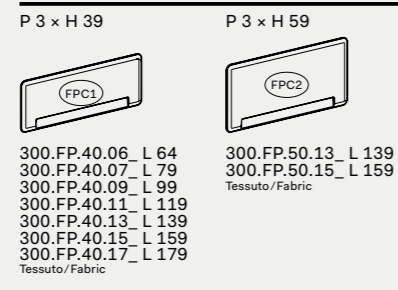

Frontal panels H 65

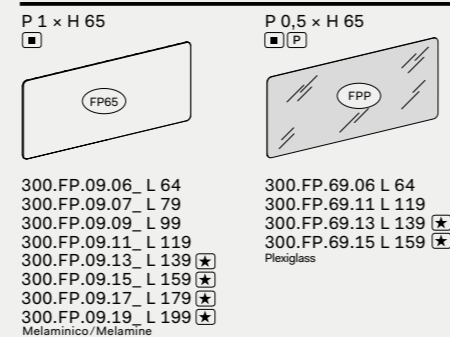

^(★) N.B.: Per i frontal con lunghezza maggiore o uguale ai 139 cm, ordinare 2 kit di supporti per frontal panel / Note: For frontal panels with a length greater than or equal to 139 cm, order 2 kits of clamps-supports for frontal panels

Accessori per frontal panels in melaminico / Accessories for melamine frontal panels

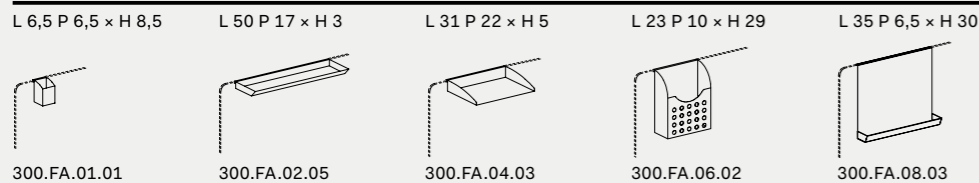

^(Note:) Il posizionamento degli accessori sui frontal panel in vetro prevede l'utilizzo di una guarnizione in PVC trasparente (Optional su richiesta) / Placement of accessories on glass front panel need the use of a transparent PVC gasket (Optional on request)
 Non utilizzabile su frontal panels in plexiglass e frontal panels in tessuto fonoassorbente / Not usable for plexiglass frontal panels and acoustic frontal panels

Note:

⁽¹⁾ Le dimensioni sono espresse in cm - consultare il listino prezzi per le caratteristiche tecniche, i codici degli articoli e delle finiture / Dimensions are stated in cm - for technical characteristics, article code numbers and finishing see price list;

^(■) Prodotti non in pronta consegna. Per la disponibilità contattare l'ufficio commerciale / Items not in prompt delivery. Please contact the commercial department to check availability;

^(A) Morsetti o supporti in ABS / ABS clamps
^(Z) Morsetti o supporti in ZAMA / Zamak clamps
^(V) Vetro / Glass.
^(P) Plexiglass

Bracci porta video / Arms for video support

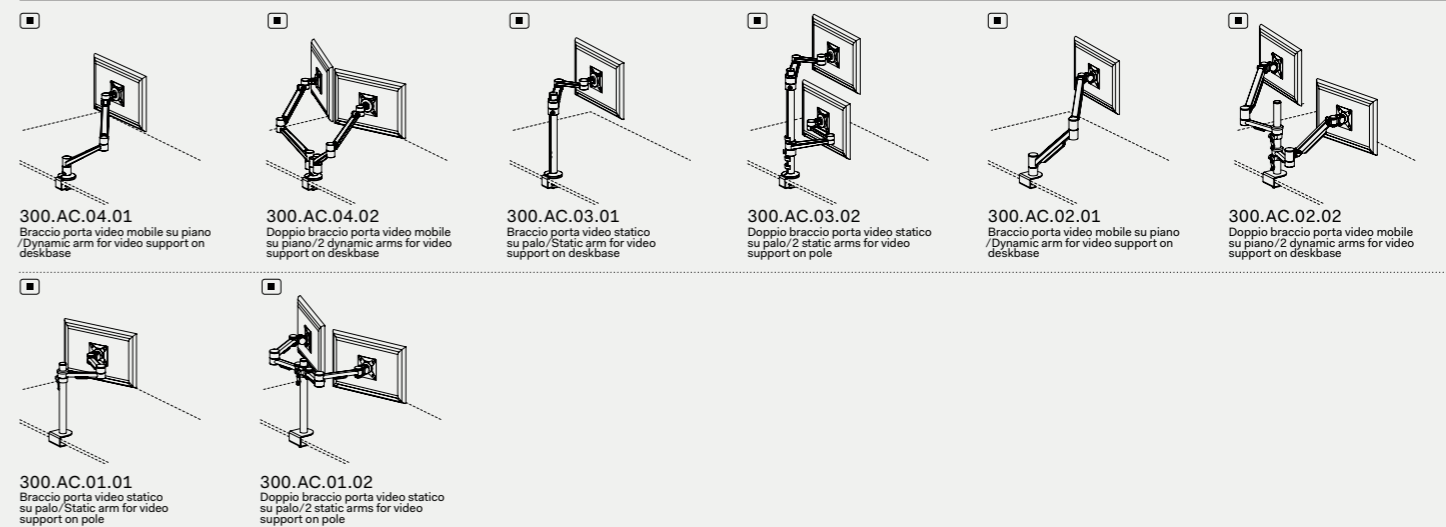

Canalizzazione - Elettrificazione - Accessori / Wire management - Electrification - Accessories

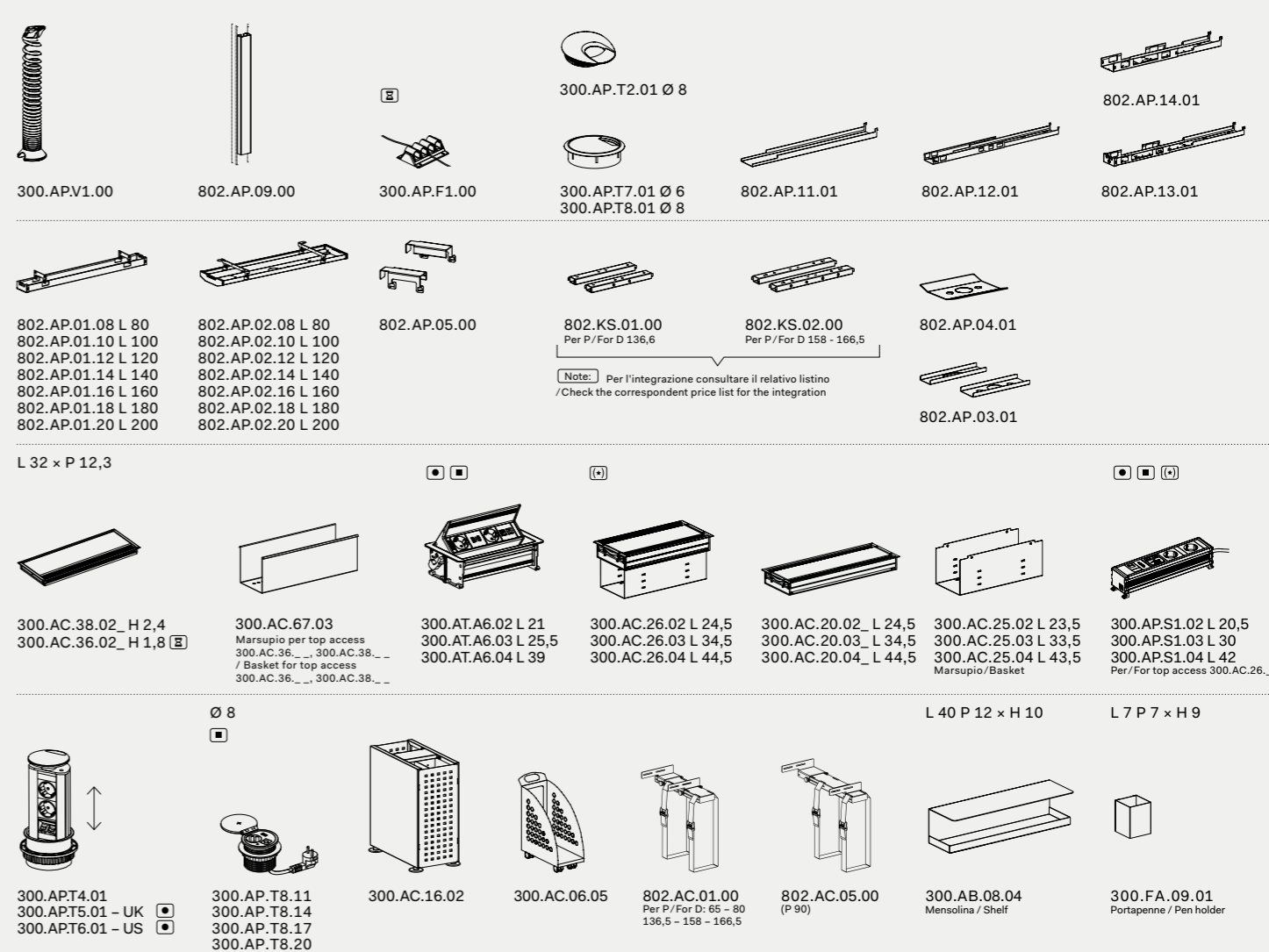

Note:

⁽¹⁾ Le dimensioni sono espresse in cm - consultare il listino prezzi per le caratteristiche tecniche, i codici degli articoli e delle finiture / Dimensions are stated in cm - for technical characteristics, article code numbers and finishing see price list;

⁽²⁾ Per la scelta dei contenitori e degli accessori vari, consultare il relativo listino o catalogo / To choose storage units and accessories, please check correspondent price list or catalogue;

^(■) Prodotti non in pronta consegna. Per la disponibilità contattare l'ufficio commerciale / Items not in prompt delivery. Please contact the commercial department to check availability;

^(□) Articoli prodotti solo su richiesta / Items produced only on demand;

^(■) Fino ad esaurimento / Until exhaustion;

DV803 Nobu

Design:
Perin & Topan

Comp. N°1

IT L'esatta espressione di chiarezza e leggerezza costruttiva – Si pone come prodotto che predilige l'operatività; con la sua semplicità strutturale, forme minimali ed eleganti configura e personalizza gli ambienti di lavoro. La serie DV803 si impreziosisce di nuove tipologie di scrivanie con regolazione elettrica dell'altezza del piano di lavoro.

EN The exact expression of clarity and lightness of construction – it stands out as a product enforcing productivity; with its light design of structure added to the minimal and elegant shapes it configures and customizes any workplace. The DV803 has extended its collection with new types of desks with electrical height adjustable worktop.







DV803 Nobu

Design:
Perin & Topan

Comp. N°2









DV803 Nobu

Design:
Perin & Topan

Comp. N°3

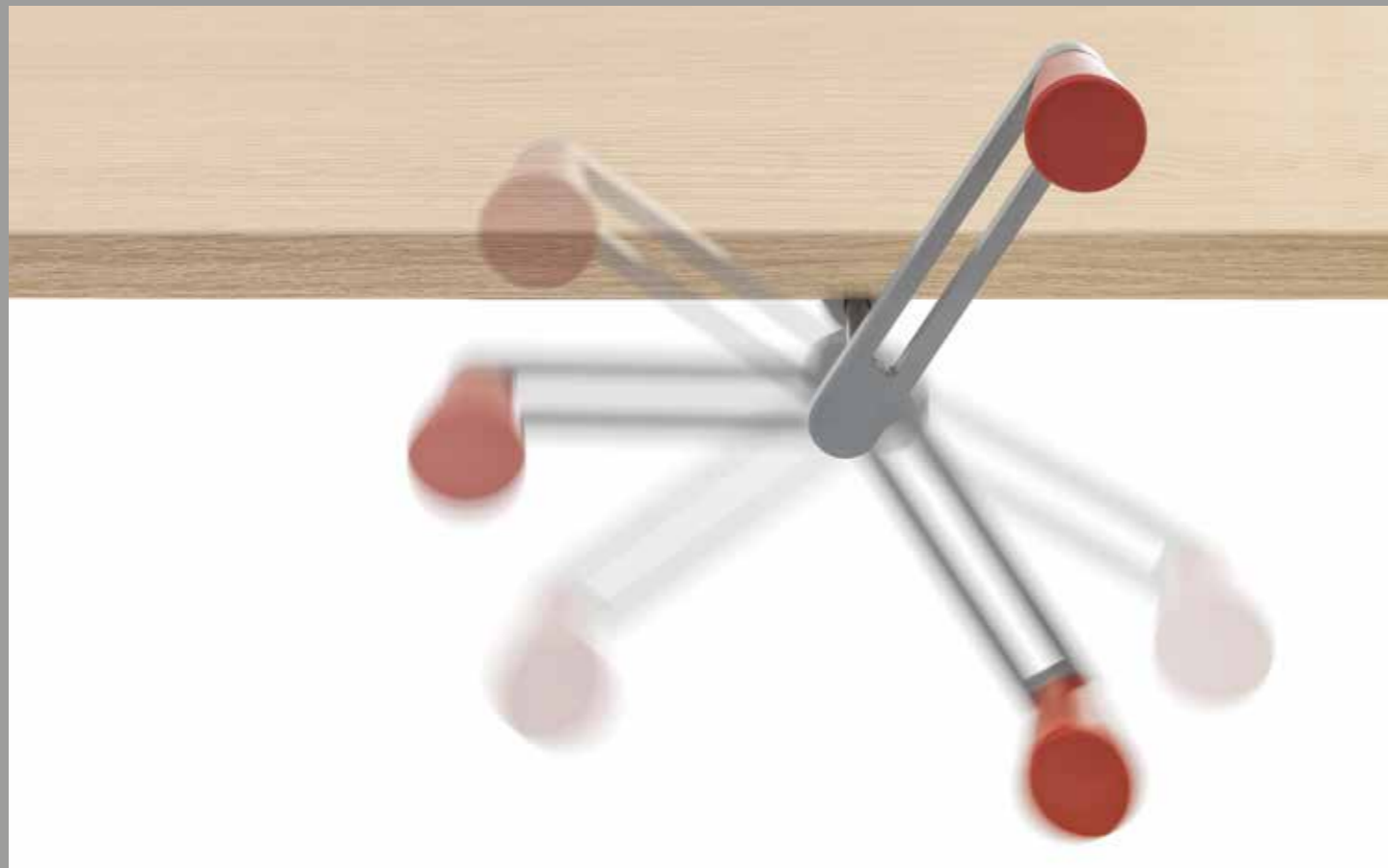



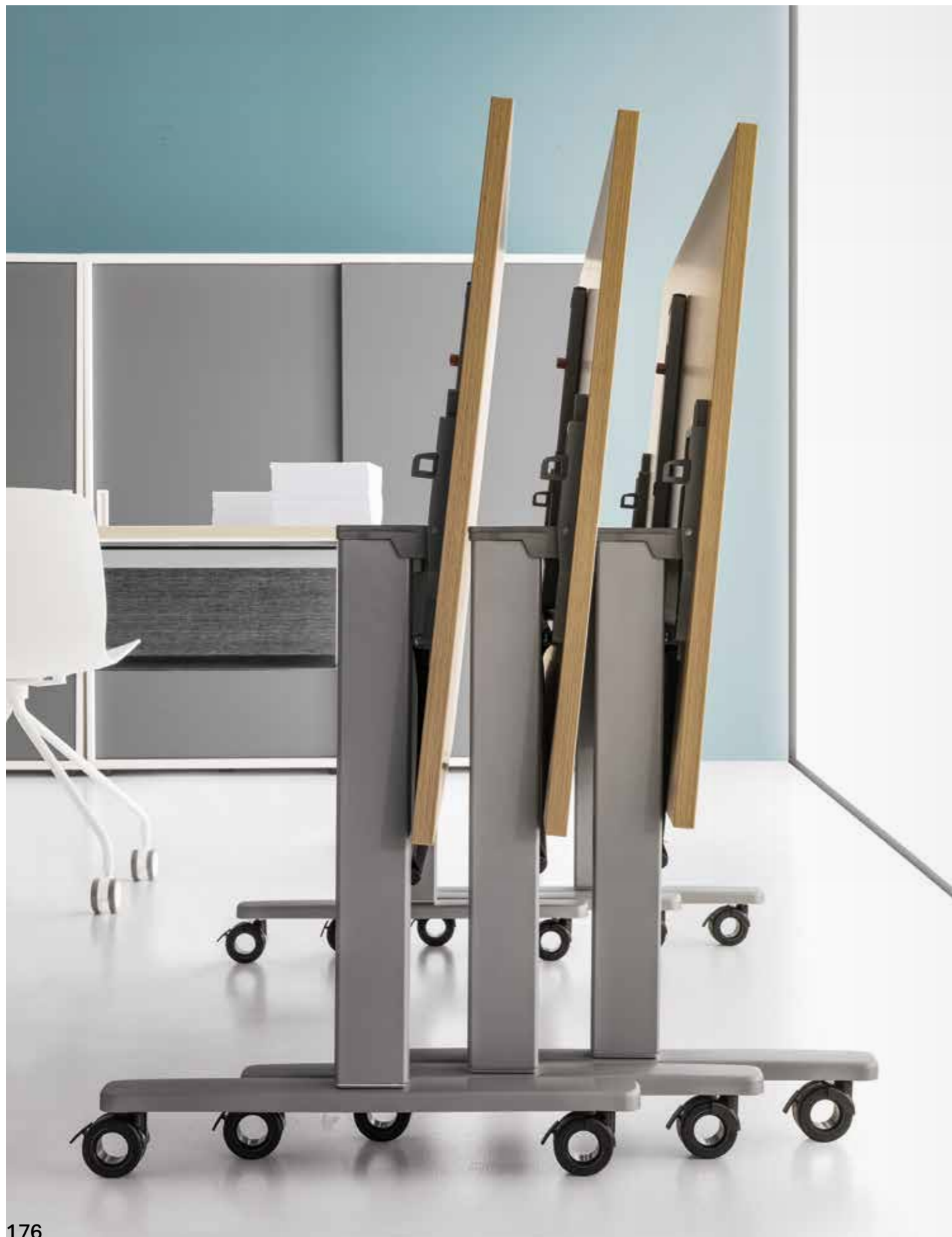

DV803 Nobu

Design:
Perin & Topan

Comp. N°4







DV803 Nobu

Design:
Perin & Topan

Comp. N°5A









Tavoli/Tables

Piani di lavoro sp. 2.5 cm, in melaminico con bordi in ABS sp. 0.2 cm / Worktops 2.5 cm thick, in melamine with ABS edge-profiles 0.2 cm thick
Modesty panel sp. 1.8 cm, in melaminico/Modesty panel 1.8 cm thick, in melamine

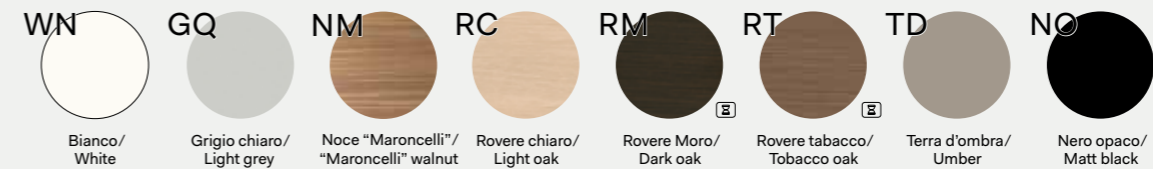

Strutture metalliche/Metal structures (*)Strutture metalliche con regolazione in altezza elettrica solo in bianco/(*)Metal structures with electric height adjustment only in white)



Mobili di servizio/Service units

Scocca e ripiani sp. 1.8 cm, in melaminico/Bodies and shelves 1.8 cm thick, in melamine



Ante scorrevoli sp. 1.8 cm, in melaminico con bordo ABS sp. 0.15 cm colore alluminio/Sliding doors 1.8 cm thick, in melamine with aluminium-coloured ABS edge-profiles 0.15 cm thick

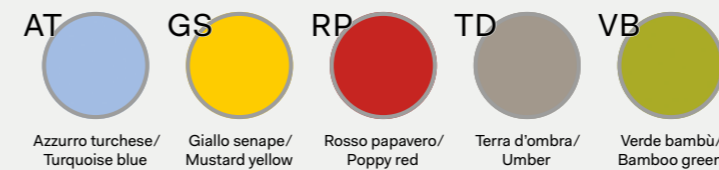

Ante scorrevoli sp. 1.8 cm, in melaminico con bordo ABS sp. 0.15 cm in tinta/Sliding doors 1.8 cm thick, in melamine with ABS edge-profiles 0.15 cm thick, in same color



Tavoli con piano ribaltabile/Tables with folding worktop

Piani di lavoro sp. 2.5 cm, in melaminico con bordi in ABS sp. 0.2 cm/Worktops 2.5 cm thick, in melamine with ABS edge-profiles 0.2 cm thick



Strutture metalliche / Metalstructures

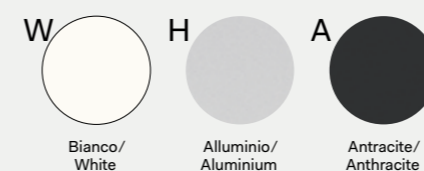

Modesty panel in tessuto/Fabric modestypanel

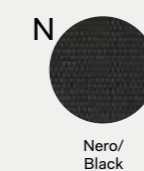

Note

Per i colori e le finiture dei Frontal Panels, vedere il relativo capitolo in DV300 - Accessori. / For colours and finishes of Frontal Panels, see the chapter in DV300 - Accessories.
 ■ Prodotti non in pronta consegna. Per la disponibilità contattare l'ufficio commerciale./Items not in prompt delivery. Please contact the commercial department to check availability.
 ☒ Fino ad esaurimento. / Until exhaustion.

Piani di lavoro in melaminico sp. 25 mm con bordi perimetrali in ABS/Worktops in melamine 1" thick with perimetrical edges in ABS

Tavoli scrivania altezza fissa H 74 (tipo C)/Fix desks height, H 74 cm (type C)

Tavoli scrivania/Desks

P 65 x H 74

803.TS.01.08_L 80
803.TS.01.10_L 100
803.TS.01.12_L 120
803.TS.01.14_L 140
803.TS.01.16_L 160
803.TS.01.18_L 180

P 80 x H 74

803.TS.05.08_L 80
803.TS.05.10_L 100
803.TS.05.12_L 120
803.TS.05.14_L 140
803.TS.05.16_L 160
803.TS.05.18_L 180

P 80 x H 74

803.TS.02.08_L 80
803.TS.02.10_L 100
803.TS.02.12_L 120
803.TS.02.14_L 140
803.TS.02.16_L 160
803.TS.02.18_L 180
803.TS.02.20_L 200

P 80 x H 74

803.TS.06.08_L 80
803.TS.06.10_L 100
803.TS.06.12_L 120
803.TS.06.14_L 140
803.TS.06.16_L 160
803.TS.06.18_L 180
803.TS.06.20_L 200

Tavoli executive/Executive tables

P 100 x H 74

803.TS.03.20_L 200
803.TS.07.20_L 200

Allunghi laterali (Dx - Sx)/Lateral extension (R - L)

P 65 x H 74

803.TD.01.08_L 80
803.TD.01.10_L 100
803.TD.01.12_L 120

803.TD.07.08_L 80
803.TD.07.10_L 100
803.TD.07.12_L 120

Allunghi su cassettiere portanti / Extensions on carrying pedestals

L 100 P 65 x H 74

803.AL.01.10_

803.AL.06.10_

Cassettiere portanti/Carrying pedestals

L 42 P 65 x H 71,5

550.CS.30.04_

550.CS.40.04_

H 2,5

550.CG.14.04_ Top

H 1,8

550.CG.12.04 Zoccolo (Optional) / Base frame (Optional)

803.ST.01.00

Contenitori H 74/Storage units H 74

L 80 P 33 x 71,5

550.CG.01.08_ A giorno/Open

550.CC.02.08_ Con ante/With doors

H 2,5

550.CG.14.08_ Top

H 1,8

550.CG.12.08 Zoccolo (Optional) / Base frame (Optional)

Tavoli P 136,5 e 166,5 a 2 scrivanie contrapposte/Benches 136,5 and 166,5 depth

P 136,5 x H 74

803.TB.01.14_L 140
803.TB.01.16_L 160

P 166,5 x H 74

803.TB.11.14_L 140
803.TB.11.16_L 160

803.TB.06.14_L 140
803.TB.06.16_L 160

803.TB.16.14_L 140
803.TB.16.16_L 160

Cassettiere/Pedestals

L 42 P 57 x H 55,5

550.CS.10.04_ Melaminico/Melamine

550.CS.20.04_ Melaminico/Melamine

L 32,2 P 54,2 x H 55,5

550.CS.1M.03_ Metalliche/Metallic

550.CS.2M.03_ Metalliche/Metallic

L 42,2 P 54,2 x H 55,5

550.CS.1M.04_ Metalliche - Vaschetta porta cancelleria inclusa/Metallic - Stationery tray included

550.CS.2M.04_ Metalliche - Vaschetta porta cancelleria inclusa/Metallic - Stationery tray included

Note: La finitura impiallacciato non è in pronta consegna. Per la disponibilità contattare l'ufficio commerciale. Per portacancelleria cassetti, vedi capitolo DV300-Accessori/Veneered finish is not in prompt delivery. Please contact the commercial department to check availability. For stationary tray, see chapter DV300-Accessories

Note:

- 1 Le dimensioni sono espresse in cm - consultare il listino prezzi per le caratteristiche tecniche, i codici degli articoli e delle finiture/Dimensions are stated in cm - for technical characteristics, article code numbers and finishing see price list;
- 2 Prodotti non in pronta consegna. Per la disponibilità contattare l'ufficio commerciale/Items not in prompt delivery. Please contact the commercial department to check availability;
- 3 Senza binario/Without rail;
- 4 Con serratura / With lock;
- 5 Non utilizzabili su tavoli regolabili /Can not be used on adjustable tables.

Piani di lavoro in melaminico sp. 25 mm con bordi perimetrali in ABS/Worktops in melamine 1" thick with perimetrical edges in ABS

Cassettiere sospese/Hanged pedestals

L 33 P 53 x H 44

803.CS.11.03 Sospesa melaminico /Hanged melamine

L 32,5 P 52 x H 14,5

803.CA.01.05 Sospesa metallica /Hanged metallic

Mobili di servizio con ante scorrevoli/Service units with sliding doors

L 160 P 48 x H 58

803.MS.02.16_ Monofacciale/Uniface

L 160 P 48 x H 58

803.MS.01.16_ Bifacciale/Bifacial

Optional 803.CA.01.03

Optional 503.CS.P1.00

Optional 503.CS.A5.04

Optional per cod. 803.MS.02.16_ / 803.MS.01.16_ / Optional for code 803.MS.02.16_ / 803.MS.01.16_

Tavoli integrabili su mobile di servizio/Integrable desks for service unit

P 65 x H 74

803.TI.01.14_L 140
803.TI.01.16_L 160
803.TI.01.18_L 180

P 80 x H 74

803.TI.02.14_L 140
803.TI.02.16_L 160
803.TI.02.18_L 180

P 136,5 x H 74

803.TI.04.14_L 140
803.TI.04.16_L 160

P 166,5 x H 74

803.TI.05.14_L 140
803.TI.05.16_L 160

Raccordi/Connection elements

L 80 P 80 x H 2,5

803.RA.01.08_

L 80 P 80 x H 74

803.RA.02.08_

L 80 P 65 x H 2,5

803.RA.03.06_ Dx/R

803.RA.04.06_ Sx/L

L 80 P 40 x H 2,5

803.PT.07.08_

L 100 P 50 x H 74

803.PT.11.10_

L 136,5 P 68 x H 74

803.PT.09.13_

L 166,5 P 83 x H 74

803.PT.13.16_

Tavoli riunione/Conference tables

H 74

L 200 P 100 x H 74

L 240 P 120 x H 74

L 250 P 125 x H 74

L 200 P 105 x H 74

L 240 P 120 x H 74

L 250 P 125 x H 74

803.TR.01.10_ Ø100
803.TR.01.12_ Ø120

803.TR.02.20_

803.TR.02.24_

803.TR.04.25_

803.TR.03.20_

803.TR.03.24_

803.TR.05.25_

L 200 P 100 x H 74

803.TR.32.20_

L 240 P 120 x H 74

803.TR.32.24_

L 480 P 120 x H 74

803.TR.32.48_

L 250 P 125 x H 74

803.TR.32.25_

Note:

- 1 Le dimensioni sono espresse in cm - consultare il listino prezzi per le caratteristiche tecniche, i codici degli articoli e delle finiture/Dimensions are stated in cm - for technical characteristics, article code numbers and finishing see price list;
- 2 Da utilizzare solo con tavoli indipendenti/To be used with single desks;
- 3 Senza binario/Without rail;
- 4 Con serratura / With lock;

Piani di lavoro in melaminico sp. 25 mm con bordi perimetrali in ABS/Worktops in melamine 1" thick with perimetrical edges in ABS

Tavoli su ruote con piano ribaltabile / Tables on castors with flip worktop

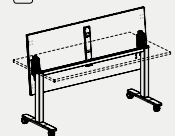
P 70 x H 74

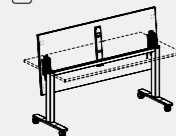
 300.TF.01.08_L 80
 300.TF.01.10_L 100
 300.TF.01.12_L 120
 300.TF.01.14_L 140
 300.TF.01.16_L 160
 300.TF.01.18_L 180

P 80 x H 74

 300.TF.02.08_L 80
 300.TF.02.10_L 100
 300.TF.02.12_L 120
 300.TF.02.14_L 140
 300.TF.02.16_L 160
 300.TF.02.18_L 180

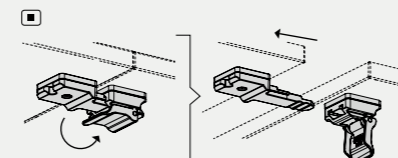
Accessori per tavoli con piano ribaltabile / Accessories for tables with flip worktop

P 1 x H 31

 300.MP.10.08_L 46,5
 300.MP.10.10_L 66,5
 300.MP.10.12_L 86,5
 300.MP.10.14_L 106,5
 300.MP.10.16_L 126,5
 300.MP.10.18_L 146,5
 Modesty Panel per tavolo con piano ribaltabile/Modesty panel for tables with flip worktop

300.KT.04.00

 Ganci per collegare in linea tavoli folding / Hooks to connect folding desks in line

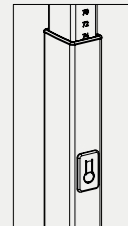
Tavoli scrivania posizionabili in altezza con pulsante da 65-86 cm (tipo B-D) / Desks with adjustable height by push-button, from 65-86 cm (type B-D)

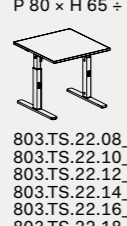
Tavoli scrivania/Desks

P 65 x H 65 ÷ 86

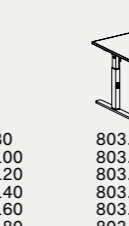
 803.TS.21.08_L 80
 803.TS.21.10_L 100
 803.TS.21.12_L 120
 803.TS.21.14_L 140
 803.TS.21.16_L 160
 803.TS.21.18_L 180

P 80 x H 65 ÷ 86

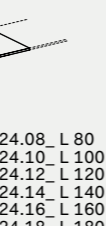
 803.TS.23.08_L 80
 803.TS.23.10_L 100
 803.TS.23.12_L 120
 803.TS.23.14_L 140
 803.TS.23.16_L 160
 803.TS.23.18_L 180

P 80 x H 65 ÷ 86

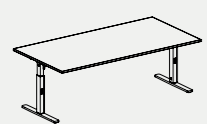
 803.TS.22.08_L 80
 803.TS.22.10_L 100
 803.TS.22.12_L 120
 803.TS.22.14_L 140
 803.TS.22.16_L 160
 803.TS.22.18_L 180

P 80 x H 65 ÷ 86

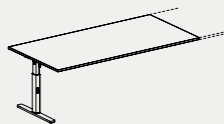
 803.TS.24.08_L 80
 803.TS.24.10_L 100
 803.TS.24.12_L 120
 803.TS.24.14_L 140
 803.TS.24.16_L 160
 803.TS.24.18_L 180

Tavoli executive/Executive tables

P 100 x H 65 ÷ 86

 803.TS.41.20_L 200

803.TS.42.20_L 200

Allunghi laterali (Dx - Sx)/Lateral extension (R - L)

P 65 x H 65 ÷ 86

 Dx/R
 Sx/L
 803.TD.21.08_L 80
 803.TD.21.10_L 100
 803.TD.21.12_L 120

Tavoli riunione/Conference tables

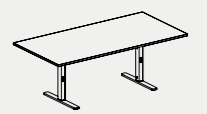
L 200 P 100 x H 65 ÷ 86

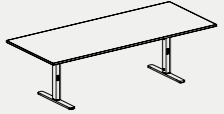
 803.TR.36.20_

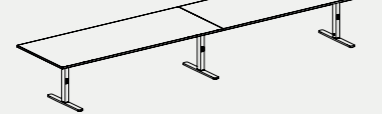
L 240 P 120 x H 65 ÷ 86

 803.TR.36.24_

L 480 P 120 x H 65 ÷ 86

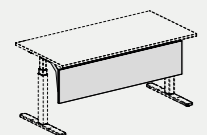
 803.TR.36.48_

L 250 P 125 x H 65 ÷ 86

 803.TR.37.25_

Modesty panels per tavoli altezza fissa/Modesty panel for fix in height tables

P 1,8 x H35

 803.MP.01.08_L 67
 803.MP.01.10_L 87
 803.MP.01.12_L 107
 803.MP.01.14_L 127
 803.MP.01.16_L 147
 803.MP.01.18_L 167
 Per tavoli/For desks

803.KT.01.00
 Kit staffe/Bracket kit

Note:
 1 Le dimensioni sono espresse in cm - consultare il listino prezzi per le caratteristiche tecniche, i codici degli articoli e delle finiture/Dimensions are stated in cm - for technical characteristics, article code numbers and finishing see price list;
 2 Prodotti non in pronta consegna. Per la disponibilità contattare l'ufficio commerciale/Items not in prompt delivery. Please contact the commercial department to check availability;

Piani di lavoro in melaminico sp. 25 mm con bordi perimetrali in ABS/Worktops in melamine 1" thick with perimetrical edges in ABS

Tavoli scrivania regolabili in altezza a due stadi con manovella da H 74 ÷ 112 cm / Adjustable height table with 2-stage height adjustment H 74 ÷ 112 cm with crank

Tavoli scrivania/Desks

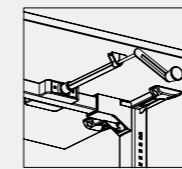
P 65 x H 74 ÷ 112

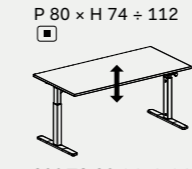
 803.TS.81.14_L 140
 803.TS.81.16_L 160
 803.TS.81.18_L 180

P 80 x H 74 ÷ 112

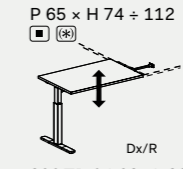
 803.TS.82.14_L 140
 803.TS.82.16_L 160
 803.TS.82.18_L 180

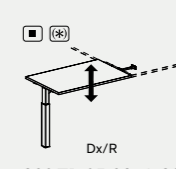
Allunghi laterali/Lateral Extension

P 65 x H 74 ÷ 112

 Dx/R
 803.TD.94.08_L 80
 803.TD.94.10_L 100

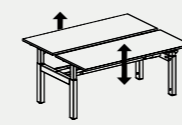
P 80 x H 74 ÷ 112

 Dx/R
 803.TD.95.08_L 80
 803.TD.95.10_L 100

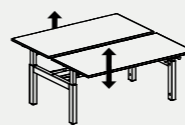
Tavoli a 2 scrivanie contrapposte/Benches

P 136,5 x H 74 ÷ 112

 803.TB.80.14_L 140
 803.TB.80.16_L 160

P 166,5 x H 74 ÷ 112

 803.TB.81.14_L 140
 803.TB.81.16_L 160

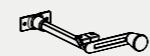
Note: Manovella non inclusa / Crank not included

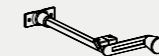
Manovelle per tavoli scrivania tipo A / Cranks for desks type A

803.KT.06.00 P 65
 Per tavoli scrivania P 65 - 136,5
 For desks P 65 - 136,5

803.KT.08.00 P 80
 Per tavoli scrivania P 80 - 166,5
 For desks P 80 - 166,5

Note: Manovelle obbligatorie da aggiungere ai tavoli regolabili in altezza a due stadi (tipo A) secondo gli esempi riportati/Required cranks to be added at desks adjustable in height at two levels (type A) according to the following examples

Schema tavoli con manovelle (X - Y) da aggiungere all'ordine / Desk scheme with cranks (X - Y) to be added to the order

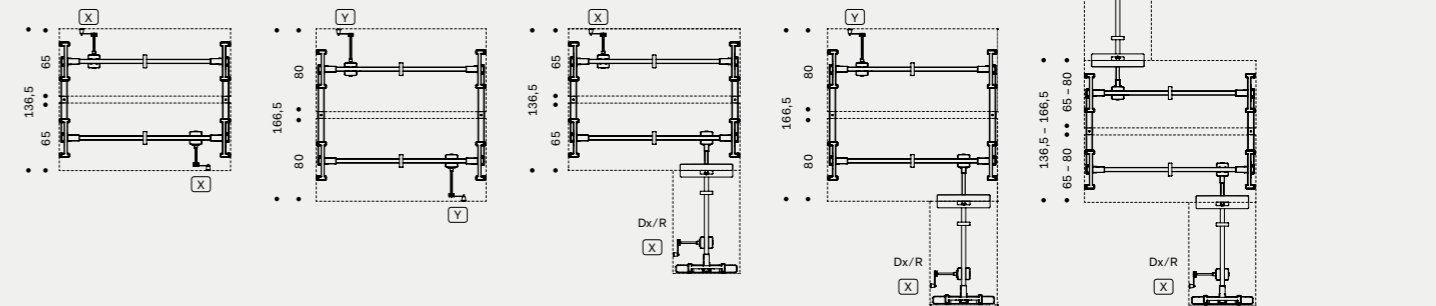

Tavoli scrivania regolabili in altezza a tre stadi elettricamente da H 65-125 cm (tipo A) / Desks adjustable in H electrical at three stages from H 65 to H 125 cm (type A)

Tavoli scrivania/Desks

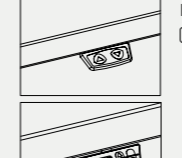
P 65 x H 65 ÷ 125

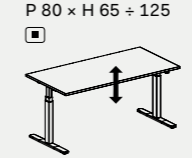
 803.TS.57.14_L 140
 803.TS.57.16_L 160
 803.TS.57.18_L 180

P 80 x H 65 ÷ 125

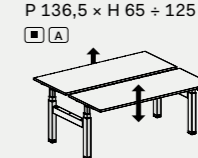
 803.TS.58.14_L 140
 803.TS.58.16_L 160
 803.TS.58.18_L 180

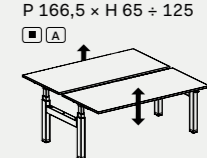



Tavoli a 2 scrivanie contrapposte/Benches

P 136,5 x H 65 ÷ 125

 803.TB.32.14_L 140
 803.TB.32.16_L 160
 803.TB.32.18_L 180

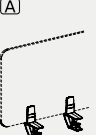
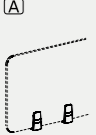

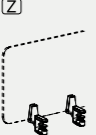
P 166,5 x H 65 ÷ 125

 803.TB.33.14_L 140
 803.TB.33.16_L 160
 803.TB.33.18_L 180

Note:
 1 Le dimensioni sono espresse in cm - consultare il listino prezzi per le caratteristiche tecniche, i codici degli articoli e delle finiture/Dimensions are stated in cm - for technical characteristics, article code numbers and finishing see price list;
 2 I tavoli in allungo laterale (R) sono integrabili solo in versione Dx /The extension tables (R) can be used only on the RH side;
 3 Tastierino per regolazione altezza piano con memorie / Control pad with memories for height adjustable worktop
 4 Senza binario/Without rail;
 5 Prodotti non in pronta consegna. Per la disponibilità contattare l'ufficio commerciale/Items not in prompt delivery. Please contact the commercial department to check availability;



Morsetti e supporti per frontal panels Sp. 0,5 - 0,8 - 1 - 3 / Clamps for frontal panels T. 0,5 - 0,8 - 1 - 3

 300.FP.27.00 Per piani /For worktops	 300.FP.28.00 Per piani-binari /For worktops-track	 300.FP.33.00 Free standing per piani /Free standing for worktops	 300.FP.10.00 Per piani /For worktops	 300.FP.22.00 Per piani-binari /For worktops-track	 300.FP.33.00 Free standing per piani /Free standing for worktops
Per frontal panels/For frontal panels FP1 FP6S FPP FP08 FPC1 FPC2					



Frontal panels sp. 1 - sp. 0,8

 P 1 x H 39 300.FP.06.06_L 64 300.FP.06.07_L 79 300.FP.06.09_L 99 300.FP.06.11_L 119 300.FP.06.13_L 139 300.FP.06.15_L 159 300.FP.06.17_L 179 300.FP.06.19_L 199 Melaminico/Melamine	 P 0,8 x H 39 300.FPV1.06_L 64 300.FPV1.07_L 79 300.FPV1.09_L 99 300.FPV1.11_L 119 300.FPV1.13_L 139 300.FPV1.15_L 159 300.FPV1.17_L 179 300.FPV1.19_L 199 Vetro/Glass
--	---

Frontal panel fonoassorbenti sp. 3
/Acoustic frontal panels t. 3

 P 3 x H 39 300.FP.40.06_L 64 300.FP.40.07_L 79 300.FP.40.09_L 99 300.FP.40.11_L 119 300.FP.40.13_L 139 300.FP.40.15_L 159 300.FP.40.17_L 179 Tessuto/Fabric	 P 3 x H 59 300.FP.50.13_L 139 300.FP.50.15_L 159 Tessuto/Fabric
--	--

Frontal panels H. 65



 P 1 x H 65 300.FP.09.06_L 64 300.FP.09.07_L 79 300.FP.09.09_L 99 300.FP.09.11_L 119 300.FP.09.13_L 139 300.FP.09.15_L 159 300.FP.09.17_L 179 300.FP.09.19_L 199 Melaminico/Melamine	 P 0,5 x H 65 300.FP.69.06_L 64 300.FP.69.11_L 119 300.FP.69.13_L 139 300.FP.69.15_L 159 Plexiglass
--	--

* N.B.: Per i frontal con lunghezza maggiore o uguale a 139 cm, ordinare 2 kit di supporti per frontal panel / Note: For frontal panels with a length greater than or equal to 139 cm, order 2 kits of clamps-supports for frontal panels





Frontal panels in tessuto con morsetti integrati
/Fabric frontal panels with clamps

 P 4 x H 59 300.FR.07.14_L 140 300.FR.07.16_L 160 Per piani/For worktops
--

Frontal panels per bench
/Frontal panels for bench

 P 4 x H 59 300.FR.06.14_L 140 300.FR.06.16_L 160 Tessuto/Fabric Per bench altezza fissa "tipo C" /For fix bench height "type C"	 P 4 x H 79 300.FR.36.14_L 140 300.FR.36.16_L 160 Tessuto/Fabric Per bench con altezza regolabile "tipo A" /For bench with adjustable height "type A"
---	---

Accessori / Accessories

 L 6,5 P 6,5 x H 8,5 300.FA.01.01	 L 50 P 17 x H 3 300.FA.02.05	 L 31 P 22 x H 5 300.FA.04.03	 L 23 P 10 x H 29 300.FA.06.02	 L 35 P 6,5 x H 30 300.FA.08.03
---	--	--	---	--

Note: Il posizionamento degli accessori sui frontal panel in vetro prevede l'utilizzo di una guarnizione in PVC trasparente (Optional su richiesta)/Placement of accessories on glass front panel need the use of a transparent PVC gasket (Optional on request)
Non utilizzabile su frontal panels in plexiglass e frontal panels in tessuto fonoassorbente / Not usable for plexiglass frontal panels and acoustic frontal panels







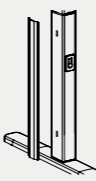
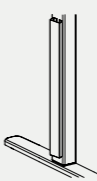

Note:

1 Le dimensioni sono espresse in cm - consultare il listino prezzi per le caratteristiche tecniche, i codici degli articoli e delle finiture/Dimensions are stated in cm - for technical characteristics, article code numbers and finishing see price list;



2 Prodotti non in pronta consegna. Per la disponibilità contattare l'ufficio commerciale/Items not in prompt delivery. Please contact the commercial department to check availability;

- A Morsetti o supporti in ABS / ABS clamps
- Z Morsetti o supporti in ZAMA / Zamak clamps
- P Plexiglass
- V Vetro/Glass.

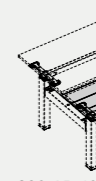
Canalizzazione - Elettrificazione/Wire management - Electrification

 803.AP.08.06 Per gambe fisse "tipo C" /For fix legs height "type C"	 803.AP.09.06 Per gambe regolabili "tipo B-D" /For legs with adjustable height "type B-D"	 803.AP.09.00 Per tavoli con piano ribaltabile /For desk with folding worktop	 300.AP.V1.00	 300.AP.F1.00	 300.AP.T2.01 Ø 8	
 300.AC.26.02 L 24,5 300.AC.26.03 L 34,5 300.AC.26.04 L 44,5	 300.AP.S1.02 L 20,5 300.AP.S1.03 L 30 300.AP.S1.04 L 42 Per/For top access 300.AC.26_	 300.AT.A6.02 L 21 300.AT.A6.03 L 25,5 300.AT.A6.04 L 39	 300.AP.T8.11 300.AP.T8.14 300.AP.T8.17 300.AP.T8.20	 300.AP.T4.01 300.AP.T5.01 - UK 300.AP.T6.01 - US	 300.AC.38.02_H 2,4	 300.AC.67.03 Marsupio per top access 300.AC.38_... 300.AC.38_... /Basket for top access 300.AC.36_... 300.AC.36_...
 803.AC.02.02 Per tavoli bench regolabili in altezza elettricamente / For bench desks adjustable in height	 803.AP.10.00 Per tavoli bench regolabili in altezza elettricamente-a manovella / For bench desks adjustable in height by crank - electrical	 803.AP.02.14 L 140 803.AP.02.16 L 160 803.AP.02.18 L 180 Per tavoli a due scrivanie contrapposte /For benches	 803.AP.43.14_L 140 803.AP.43.16_L 160 803.AP.43.18_L 180 Carter di copertura per canaline bench / Bench cable-channel cover casing	 803.AC.01.02	 300.AC.06.05	

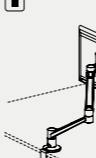
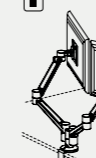
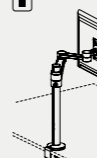
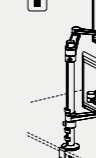
Bracci porta video/Arms for video support

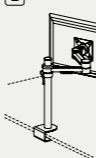
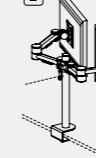
 300.AC.04.01 Braccio porta video mobile su piano /Dynamic arm for video support on deskbase	 300.AC.04.02 Doppio braccio porta video mobile su piano/2 dynamic arms for video support on deskbase	 300.AC.03.01 Braccio porta video statico su palo/Static arm for video support on deskbase	 300.AC.03.02 Doppio braccio porta video statico su palo/2 static arms for video support on pole	 300.AC.02.01 Braccio porta video mobile su piano /Dynamic arm for video support on deskbase	 300.AC.02.02 Doppio braccio porta video mobile su piano/2 dynamic arms for video support on deskbase
 300.AC.01.01 Braccio porta video statico su palo/Static arm for video support on pole	 300.AC.01.02 Doppio braccio porta video statico su palo/2 static arms for video support on pole				

Note:

1 Le dimensioni sono espresse in cm - consultare il listino prezzi per le caratteristiche tecniche, i codici degli articoli e delle finiture/Dimensions are stated in cm - for technical characteristics, article code numbers and finishing see price list;
2 Per la scelta dei contenitori e degli accessori vari, consultare il relativo listino o catalogo/To choose storage units and accessories, please check correspondent price list or catalogue;

- 2 Prodotti non in pronta consegna. Per la disponibilità contattare l'ufficio commerciale/Items not in prompt delivery. Please contact the commercial department to check availability;
- 3 Articoli prodotti solo su richiesta/Items produced only on demand;
- 4 Fino ad esaurimento/Until exhaustion;

DV807 4S

Design:
Antonio Morello

IT Essenzialità di stile – Serie operativa dallo stile essenziale, lineare ma nello stesso tempo deciso e contemporaneo. Le due tipologie di gambe, diritta e a cavalletto, si integrano con armonia alle nuove finiture dei piani, rendendo la collezione perfettamente adattabile ad ogni spazio lavoro.

EN Style essentiality – Operative series with an essential, linear but at the same time impressive and contemporary style. The two types of legs, straight and trestle, blend harmoniously with new finishes of the worktops, making it perfectly adaptable to every work environment.









Tavoli/Tables

Piani di lavoro sp. 2.5 cm, in melaminico con bordi in ABS sp. 0.2 cm/Worktops 2.5 cm thick, in melamine with ABS edge-profiles 0.2 cm thick



Strutture metalliche/Metal structures

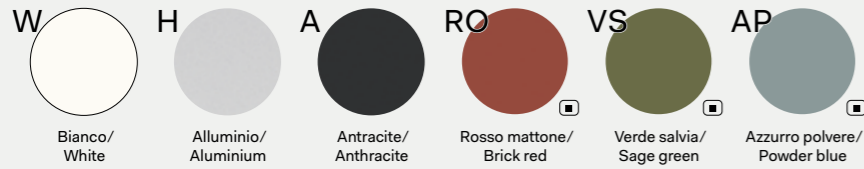

Mobili di servizio/Service units

Scocca e ripiani sp. 1.8 cm, in melaminico/Bodies and shelves 1.8 cm thick, in melamine

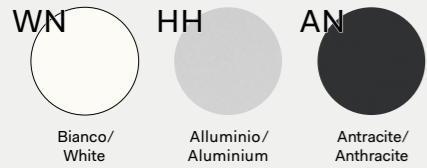

Ante scorrevoli sp. 1.8 cm, in melaminico con bordo ABS sp. 0.15 cm colore alluminio/Sliding doors 1.8 cm thick, in melamine with aluminium-coloured ABS edge-profiles 0.15 cm thick

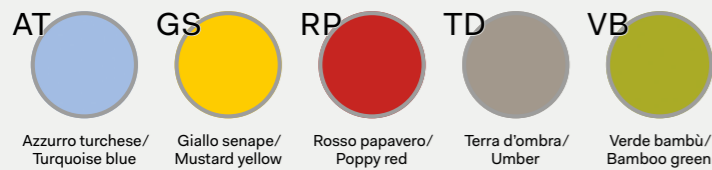

Ante scorrevoli sp. 1.8 cm, in melaminico con bordo ABS sp. 0.15 cm in tinta/Sliding doors 1.8 cm thick, in melamine with ABS edge-profiles 0.15 cm thick, in same color



Note

Per i colori e le finiture dei Frontal Panels, vedere il relativo capitolo in DV300 - Accessori. / For colours and finishes of Frontal Panels, see the chapter in DV300 - Accessories.
 [] Prodotti non in pronta consegna. Per la disponibilità contattare l'ufficio commerciale./Items not in prompt delivery. Please contact the commercial department to check availability.
 [] Fino ad esaurimento. / Until exhaustion.

Piani di lavoro in melaminico sp. 25 mm con bordi perimetrali in ABS/Worktops in melamine 25 mm thick with perimetrical edges in ABS

Tavoli scrivanie/Desks

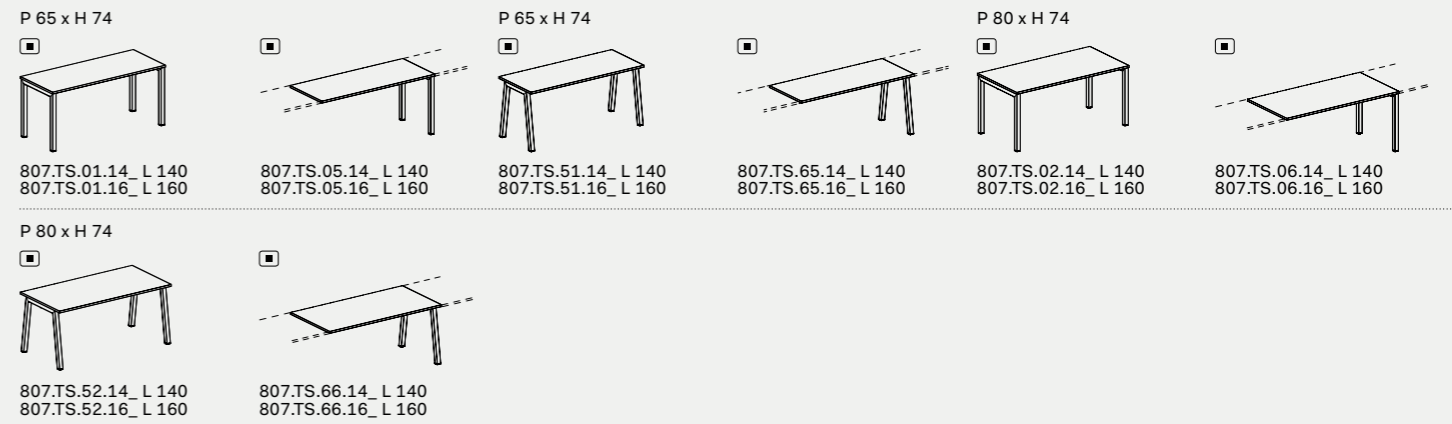

Tavoli a 2 scrivanie contrapposte/Benches

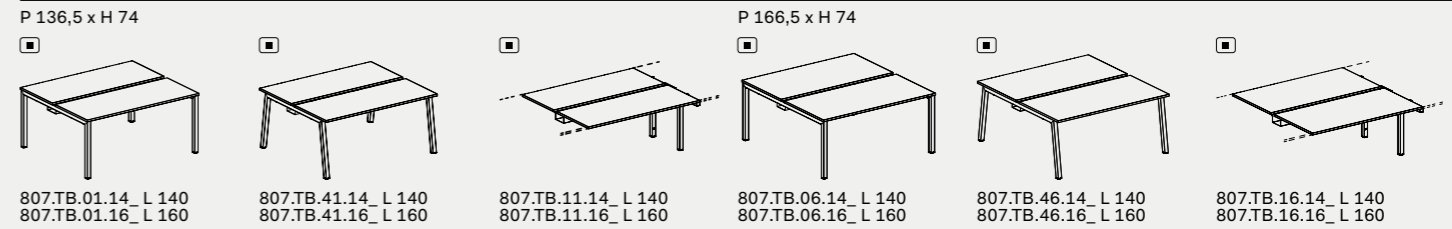

[Note:] La canalina passacavi orizzontale è compresa nel codice/The horizontal cable channel is included in codes

Tavoli a 2 scrivanie contrapposte con 2 top access/Benches with 2 top access

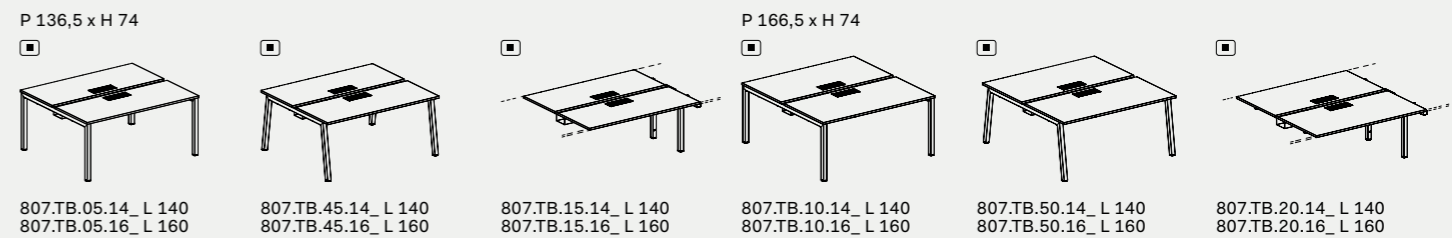

[Note:] La canalina passacavi orizzontale è compresa nel codice/The horizontal cable channel is included in codes

Cassettiere/Pedestals

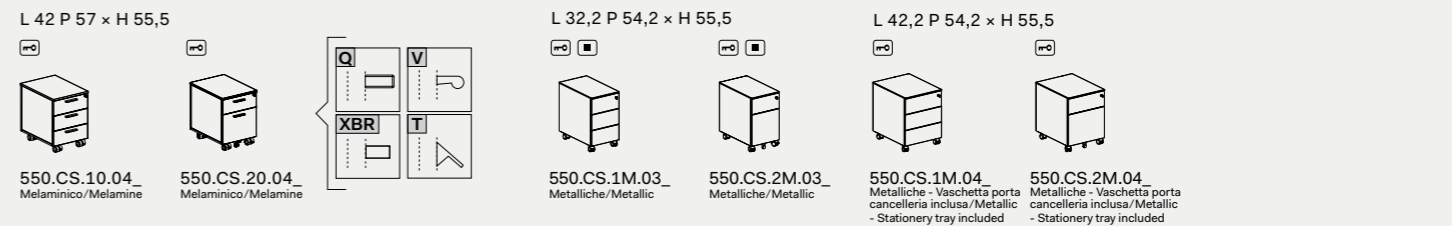

[Note:] La finitura impiallacciato non è in pronta consegna. Per la disponibilità contattare l'ufficio commerciale. Per portacancelleria cassetti, vedi capitolo DV300-Accessori /Veneered finish is not in prompt delivery. Please contact the commercial department to check availability. For stationary tray, see chapter DV300-Accessories.

Mobili di servizio/Service units

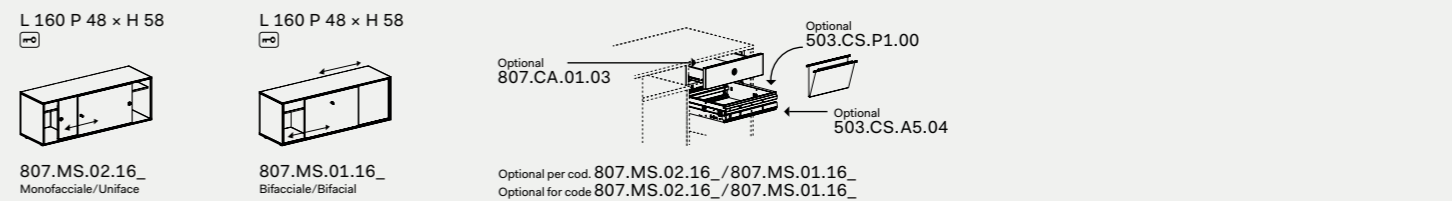

Note:

[] Le dimensioni sono espresse in cm - consultare il listino prezzi per le caratteristiche tecniche, i codici degli articoli e delle finiture/Dimensions are stated in cm - for technical characteristics, article code numbers and finishing see price list;
 [] Prodotti non in pronta consegna. Per la disponibilità contattare l'ufficio commerciale/Items not in prompt delivery. Please contact the commercial department to check availability;
 [] Con serratura/With lock.

Piani di lavoro in melaminico sp. 25 mm con bordi perimetrali in ABS/Worktops in melamine 25 mm thick with perimetrical edges in ABS

Tavoli integrabili su mobili di servizio/Desks to be completed with service units

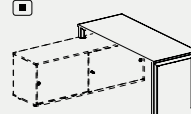
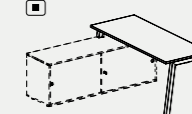
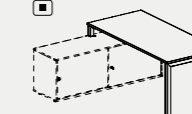
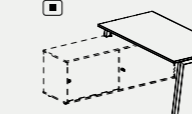
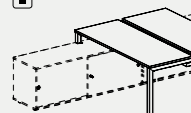
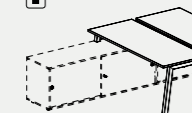
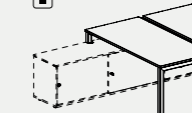
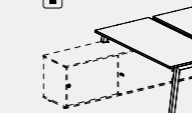
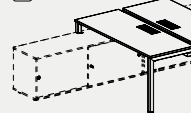
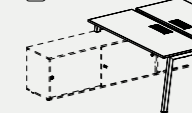
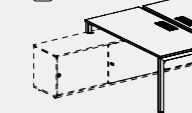
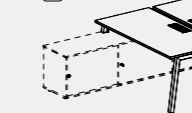
<p>P 65 x H 74</p>  <p>807.TI.01.14_L 140 807.TI.01.16_L 160</p>	<p>P 80 x H 74</p>  <p>807.TI.51.14_L 140 807.TI.51.16_L 160</p>	<p>P 80 x H 74</p>  <p>807.TI.02.14_L 140 807.TI.02.16_L 160</p>	<p>P 80 x H 74</p>  <p>807.TI.52.14_L 140 807.TI.52.16_L 160</p>
<p>P 136,5 x H 74</p>  <p>807.TI.05.14_L 140 807.TI.05.16_L 160</p>	<p>P 136,5 x H 74</p>  <p>807.TI.41.14_L 140 807.TI.41.16_L 160</p>	<p>P 166,5 x H 74</p>  <p>807.TI.06.14_L 140 807.TI.06.16_L 160</p>	<p>P 166,5 x H 74</p>  <p>807.TI.46.14_L 140 807.TI.46.16_L 160</p>
<p>P 136,5 x H 74</p>  <p>807.TI.07.14_L 140 807.TI.07.16_L 160</p>	<p>P 136,5 x H 74</p>  <p>807.TI.45.14_L 140 807.TI.45.16_L 160</p>	<p>P 166,5 x H 74</p>  <p>807.TI.10.14_L 140 807.TI.10.16_L 160</p>	<p>P 166,5 x H 74</p>  <p>807.TI.50.14_L 140 807.TI.50.16_L 160</p>

Carter metallico per piani bench/Metal casing for bench worktops

P 6,5 x H 2,5

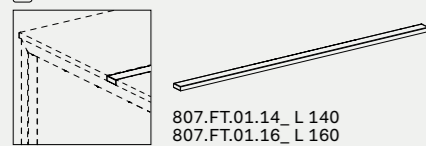

807.FT.01.14_L 140
807.FT.01.16_L 160

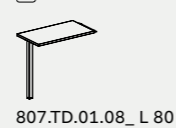

Allungo laterale/Lateral extension

P 45 x H 74



807.TD.01.08_L 80



Frontal panels Sp. 0,8 - 1

<p>P 1 x H 39</p>  <p>300.FP.06.06_L 64 300.FP.06.07_L 79 300.FP.06.09_L 99 300.FP.06.11_L 119 300.FP.06.13_L 139 300.FP.06.15_L 159 300.FP.06.17_L 179 300.FP.06.19_L 199 Melaminico/Melamine</p>	<p>P 0,8 x H 39</p>  <p>300.FPV1.06_L 64 300.FPV1.07_L 79 300.FPV1.09_L 99 300.FPV1.11_L 119 300.FPV1.13_L 139 300.FPV1.15_L 159 300.FPV1.17_L 179 300.FPV1.19_L 199 Vetro/Glass</p>
--	---

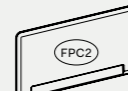
Frontal panel fonoassorbenti Sp. 3 /Acoustic frontals panels T. 3





<p>P 3 x H 39</p>  <p>300.FP.40.06_L 64 300.FP.40.07_L 79 300.FP.40.09_L 99 300.FP.40.11_L 119 300.FP.40.13_L 139 300.FP.40.15_L 159 300.FP.40.17_L 179 300.FP.40.19_L 199 Tessuto/Fabric</p>	<p>P 3 x H 59</p>  <p>300.FP.50.13_L 139 300.FP.50.15_L 159 Tessuto/Fabric</p>
--	---

Fontal panels H 65

<p>P 1 x H 65</p>  <p>300.FP.09.06_L 64 300.FP.09.07_L 79 300.FP.09.09_L 99 300.FP.09.11_L 119 300.FP.09.13_L 139 300.FP.09.15_L 159 300.FP.09.17_L 179 300.FP.09.19_L 199 Melaminico/Melamine</p>	<p>P 0,5 x H 65</p>  <p>300.FP.69.06_L 64 300.FP.69.11_L 119 300.FP.69.13_L 139 300.FP.69.15_L 159 Plexiglass</p>
--	--

N.B.: Per i frontal con lunghezza maggiore o uguale a 139 cm, ordinare 2 kit di supporti per frontal panel / Note: For frontal panels with a length greater than or equal to 139 cm, order 2 kits of clamps-supports for frontal panels

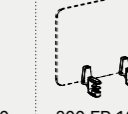
Morsetti e supporti in per frontal panels Sp. 0,5 - 0,8 - 1 - 3 /Clamps for frontal panels T. 0,5 - 0,8 - 1 - 3

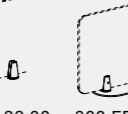
<p>A</p>  <p>300.FP.27.00 Per piani /For worktops</p>	<p>A</p>  <p>300.FP.28.00 Per piani-binari /For worktops-track</p>	<p>A</p>  <p>300.FP.33.00 Free standing per piani /Free standing for worktops</p>	<p>Z</p>  <p>300.FP.10.00 Per piani /For worktops</p>	<p>Z</p>  <p>300.FP.22.00 Per piani-binari /For worktops-track</p>	<p>Z</p>  <p>300.FP.33.00 Free standing per piani /Free standing for worktops</p>
---	---	--	--	---	--

Per frontal panels /For frontal panels (FP1) (FP65) (FPP) (FP08) (FPC1) (FPC2)

Staffe per frontal panel su bench /Brackets for frontal panel on bench

807.AC.50.00
Supporto sotto piano /For worktops-tracks

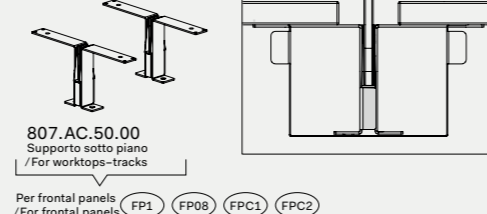

Per frontal panels /For frontal panels (FP1) (FP08) (FPC1) (FPC2)

Note:

1 Le dimensioni sono espresse in cm - consultare il listino prezzi per le caratteristiche tecniche, i codici degli articoli e delle finiture/Dimensions are stated in cm - for technical characteristics, article code numbers and finishing see price list;

2 Prodotti non in pronta consegna. Per la disponibilità contattare l'ufficio commerciale/Items not in prompt delivery. Please contact the commercial department to check availability;

A Morsetti o supporti in ABS /ABS clamps

V Vetro/Glass.

P Plexiglass





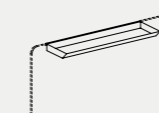
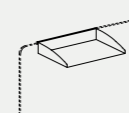
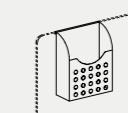
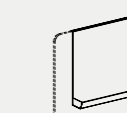



Z Morsetti o supporti in ZAMA / Zamak clamps

Accessori per frontal panels in melaminico/Accessories for melamine frontal panels

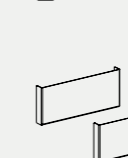
<p>L 6,5 P 6,5 x H 8,5</p>  <p>300.FA.01.01</p>	<p>L 50 P 17 x H 3</p>  <p>300.FA.02.05</p>	<p>L 31 P 22 x H 5</p>  <p>300.FA.04.03</p>	<p>L 23 P 10 x H 29</p>  <p>300.FA.06.02</p>	<p>L 35 P 6,5 x H 30</p>  <p>300.FA.08.03</p>
--	--	--	---	--

Note: Il posizionamento degli accessori sui frontal panel in vetro prevede l'utilizzo di una guarnizione in PVC trasparente (Optional su richiesta)/Placement of accessories on glass front panel need the use of a transparent PVC gasket (Optional on request)
Non utilizzabile su frontal panels in plexiglass e frontal panels in tessuto fonoassorbente /Not usable for plexiglass frontal panels and acoustic frontal panels

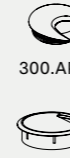
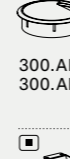
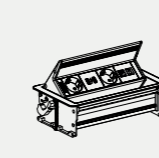
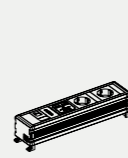
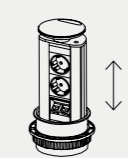
Canalizzazione - Elettrificazione - Accessori/Wire management - Electrification - Accessories

<p>807.AP.08.00_</p> 	<p>300.AP.V1.00</p> 	<p>807.AP.03.01 Prolunga canalina /Extension for cable channel</p> 	<p>807.AC.55.00 Tappi canalina /Plug for cable channel</p> 	<p>807.AP.40.00 Vasca canalina /Basket for cable channel</p> 	<p>300.AP.15.11 L 110 300.AP.15.14 L 140</p> 	<p>300.AP.F1.00</p> 
<p>300.AP.T2.01 Ø 8</p> 	<p>300.AP.T7.01 Ø 6 300.AP.T8.01 Ø 8</p> 	<p>300.AT.A6.02 L 21 300.AT.A6.03 L 25,5 300.AT.A6.04 L 39</p> 	<p>300.APS1.02 L 20,5 300.APS1.03 L 30 300.APS1.04 L 42</p> 	<p>300.APT4.01 300.APT5.01 - UK 300.APT6.01 - US</p> 	<p>300.AP.T8.11 300.AP.T8.14 300.AP.T8.17 300.AP.T8.20</p> 	<p>300.AC.67.03 Marsupio per top access 300.AC.36_... 300.AC.38_... / Basket for top access 300.AC.36_... 300.AC.38_...</p> 

Bracci porta video/Arms for video support

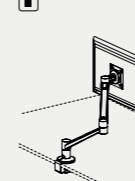
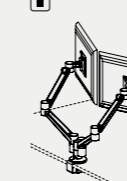
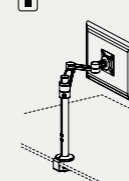
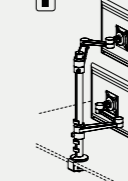
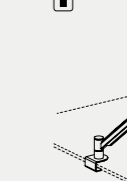
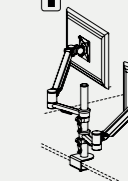
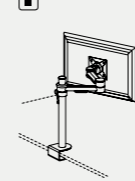
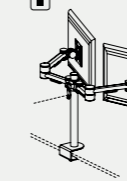
<p>300.AC.04.01 Braccio porta video mobile su piano /Dynamic arm for video support on deskbase</p> 	<p>300.AC.04.02 Doppio braccio porta video mobile su piano/2 dynamic arms for video support on deskbase</p> 	<p>300.AC.03.01 Braccio porta video statico su palo /Static arm for video support on pole</p> 	<p>300.AC.03.02 Doppio braccio porta video statico su palo/2 static arms for video support on pole</p> 	<p>300.AC.02.01 Braccio porta video mobile su piano /Dynamic arm for video support on deskbase</p> 	<p>300.AC.02.02 Doppio braccio porta video mobile su piano/2 dynamic arms for video support on deskbase</p> 
<p>300.AC.01.01 Braccio porta video statico su palo/Static arm for video support on pole</p> 	<p>300.AC.01.02 Doppio braccio porta video statico su palo/2 static arms for video support on pole</p> 				

Note:

1 Le dimensioni sono espresse in cm - consultare il listino prezzi per le caratteristiche tecniche, i codici degli articoli e delle finiture/Dimensions are stated in cm - for technical characteristics, article code numbers and finishing see price list;

2 Prodotti non in pronta consegna. Per la disponibilità contattare l'ufficio commerciale/Items not in prompt delivery. Please contact the commercial department to check availability;

3 Articoli prodotti solo su richiesta/Items produced only on demand;

4 Fino ad esaurimento/Until exhaustion;

5 Per la scelta dei contenitori e degli accessori vari, consultare il relativo listino o catalogo/To choose storage units and accessories, please check correspondent price list or catalogue;

DV805 Treko

Design:
Antonio Morello

Comp. N°1

IT Elegante semplicità – Praticità, attualità e flessibilità, sono i plus principali che consentono di arredare i moderni spazi di lavoro con estrema semplicità e funzionalità. Questa collezione utilizza le composizioni più svariate permettendo di progettare open space e spazi delimitati creando ambienti piacevoli ed accoglienti.

EN Elegant simplicity – Practicality, flexibility and timeliness are the main features that allow to furnish modern working environments with extreme simplicity and functionality. This collection allows the design of endless compositions being it open spaces or defined areas, creating a pleasant and comfortable ambience.







DV805 Treko

Design:
Antonio Morello

Comp. N°2







DV805 Treko

Design:
Antonio Morello

Comp. N°3





DV805 Treko

Design:
Antonio Morello

Comp. N°4

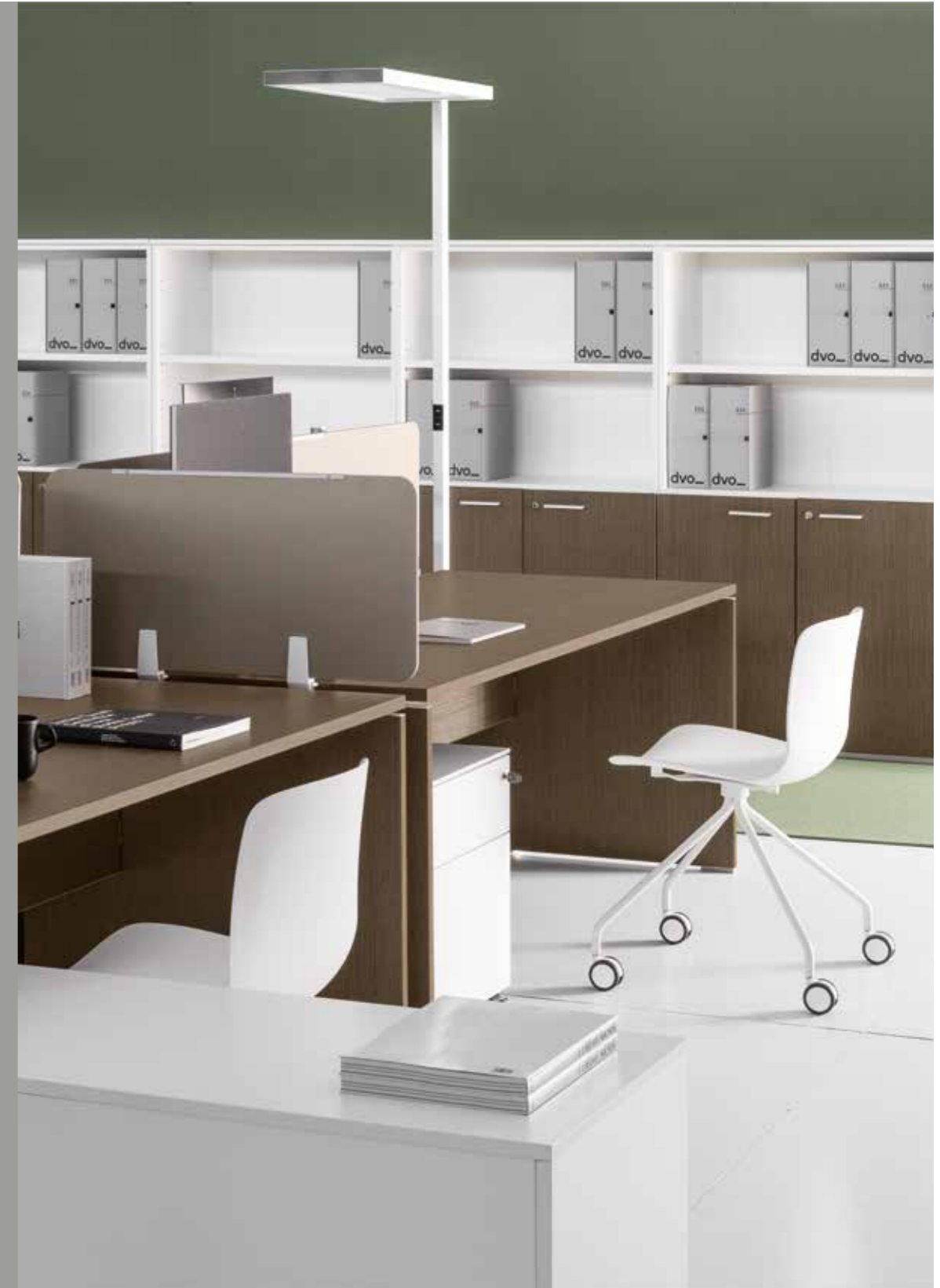







DV805 Treko

Design:
Antonio Morello

Comp. N°5





Tavoli/Tables

Piani di lavoro, gambe pannellate sp. 2.5 cm con bordi in ABS sp. 0.2 cm e modesty panels sp. 1.8 cm, in melaminico con bordo ABS colore bianco / Worktops and panelled legs 2.5 cm thick with 0.2 cm thick ABS edgebanding, modesty panels 1.8 cm thick, in melamine with white ABS edge banding



Strutture metalliche/Metal structures

Gamboni - Colonne in metallo/Metal columns

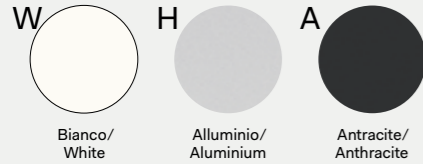

Poggiapiedi in tubo/Footrest tube



Mobili di servizio e contenitori terminali/Service units and terminal storage units

Scocca e ripiani sp. 1.8 cm, in melaminico/Bodies and shelves 1.8 cm thick, in melamine

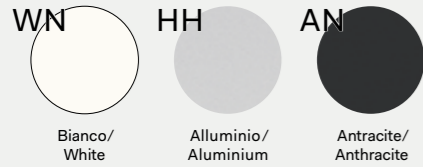

Ante scorrevoli sp. 1.8 cm, in melaminico con bordo ABS sp. 0.15 cm colore alluminio/Sliding doors 1.8 cm thick, in melamine with aluminium-coloured ABS edge-profiles 0.15 cm thick

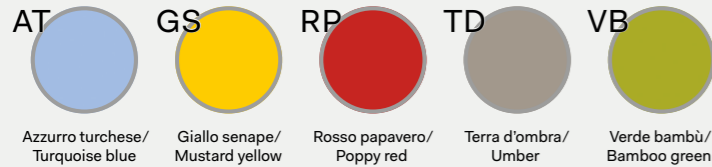

Ante scorrevoli sp. 1.8 cm, in melaminico con bordo ABS sp. 0.15 cm in tinta/Sliding doors 1.8 cm thick, in melamine with ABS edge-profiles 0.15 cm thick, in same color



Piedini livellatori e distanziali in ABS/Adjustable feet and ABS spacers

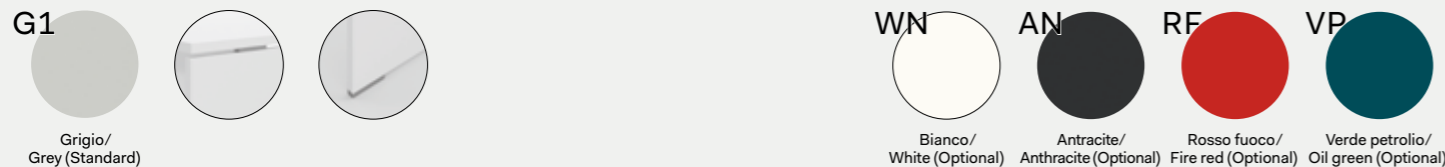

Note

Per i colori e le finiture dei Frontal Panels, vedere il relativo capitolo in DV300 - Accessori. / For colours and finishes of Frontal Panels, see the chapter in DV300 - Accessories.
 [] Prodotti non in pronta consegna. Per la disponibilità contattare l'ufficio commerciale./Items not in prompt delivery. Please contact the commercial department to check availability.
 [E] Fino ad esaurimento. / Until exhaustion.

Piani di lavoro in melaminico sp. 25 mm con bordi perimetrali in ABS/Worktops in melamine 25 mm thick with perimetrical edges in ABS

Tavoli scrivanie/Desks

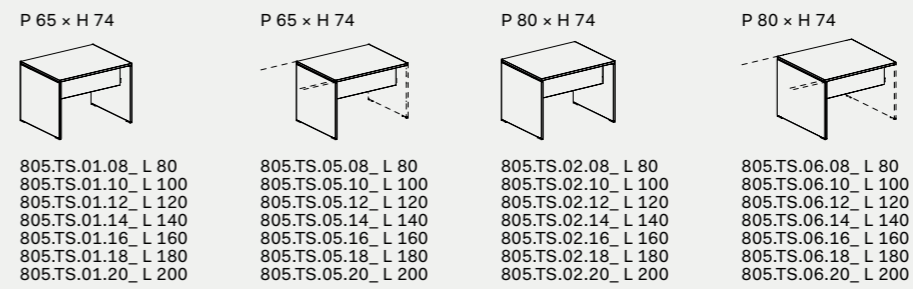

Tavoli executive/Executive tables

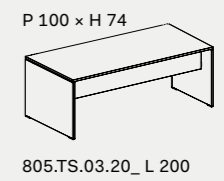

Standing tables H 107

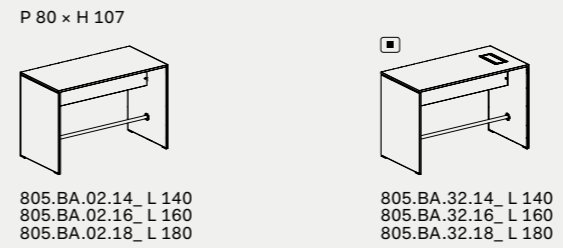

Allungo laterale/Lateral extension

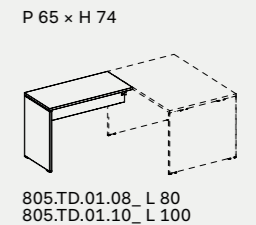

Allunghi su cassettiere portanti/Extensions on carrying pedestals

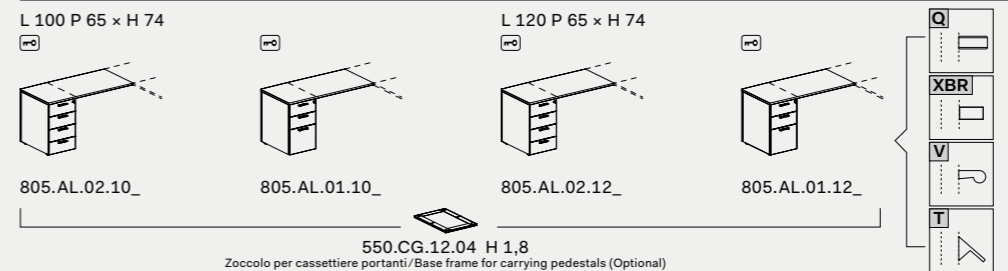

Raccordi/Connection elements

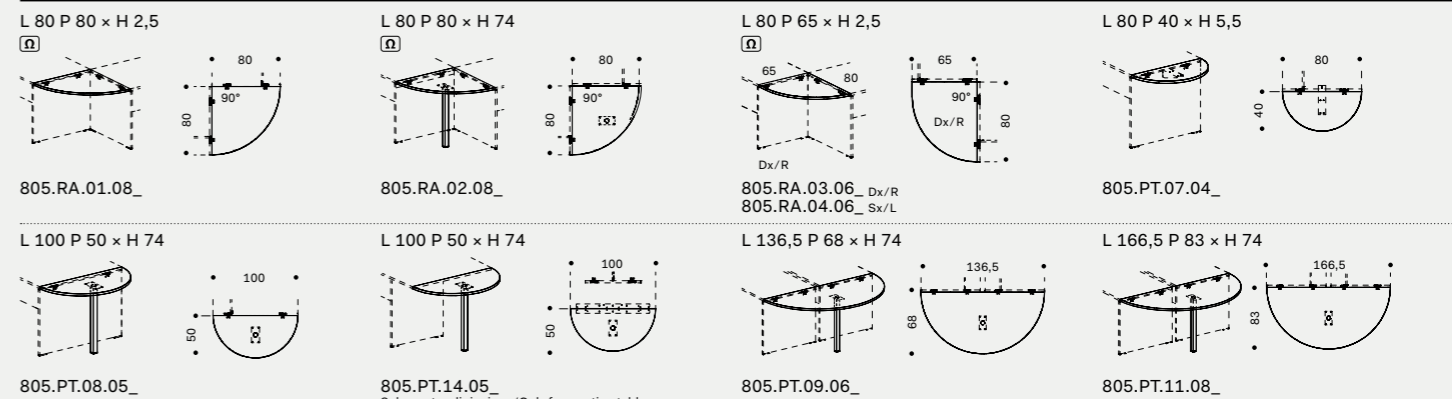

Piani terminali/Terminal tops

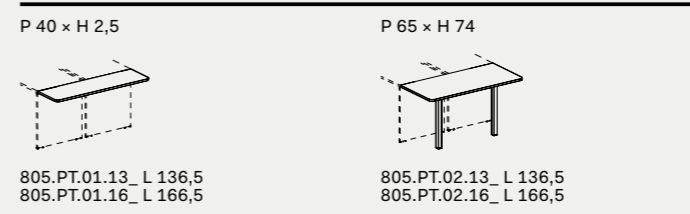

Contenitori con ante scorrevoli/Terminal storage with sliding doors

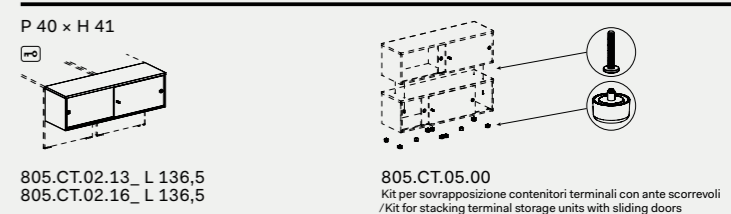

Note:

[1] Le dimensioni sono espresse in cm - consultare il listino prezzi per le caratteristiche tecniche, i codici degli articoli e delle finiture/Dimensions are stated in cm - for technical characteristics, article code numbers and finishing see price list;
 [] Prodotti non in pronta consegna. Per la disponibilità contattare l'ufficio commerciale./Items not in prompt delivery. Please contact the commercial department to check availability;
 [E] Da utilizzare solo con tavoli indipendenti /To be used with single desks
 [L] Con serratura/With lock.

Piani di lavoro in melaminico sp. 25 mm con bordi perimetrali in ABS/Worktops in melamine 25 mm thick with perimetrical edges in ABS

Mobili di servizio/Service units

L 120 P 60 x H 61,5
550.CM.S0.12_ Su ruote/On castors

L 160 P 48 x H 58
805.MS.02.16_ Monofacciale/Uniface

L 160 P 48 x H 58
805.MS.01.16_ Bifacciale/Bifacial

Optional 805.CA.01.03
Optional 503.CS.P1.00
Optional 503.CS.A5.04
Optional per cod. 805.MS.02.16_/805.MS.01.16_
Optional for code 805.MS.02.16_/805.MS.01.16_

Note: La finitura impiallacciato non è in pronta consegna. Per la disponibilità contattare l'ufficio commerciale. Per portacancelleria cassetti, vedi capitolo DV300-Accessori / Veneered finish is not in prompt delivery. Please contact the commercial department to check availability. For stationary tray, see chapter DV300-Accessories.

Cassettiere portanti/Carrying pedestals

L 42 P 65 x H 71,5
550.CS.30.04_ 550.CS.40.04_ 550.CG.12.04_ Zoccolo (Optional) /Base frame (Optional)

H 2,5
550.CG.14.04_ Top

H 1,8
550.CG.12.08_ Zoccolo (Optional) /Base frame (Optional)

Contenitori H 74/Storage units H 74

L 80 P 33 x 71,5
550.CG.01.08_ A giorno/Open 550.CC.02.08_ Con ante/With doors 550.CG.12.08_ Zoccolo (Optional) /Base frame (Optional)

H 2,5
550.CG.14.08_ Top

H 1,8
550.CG.12.08_ Zoccolo (Optional) /Base frame (Optional)

Cassettiere/Pedestals

L 42 P 57 x H 55,5
550.CS.10.04_ Melaminico/Melamine 550.CS.20.04_ Melaminico/Melamine

L 32,2 P 54,2 x H 55,6
550.CS.1M.03_ Metalliche/Metallic 550.CS.2M.03_ Metalliche/Metallic

L 42,2 P 54,2 x H 55,6
550.CS.1M.04_ Metalliche - Vaschetta porta cancelleria inclusa/Metallic - Stationery tray included 550.CS.2M.04_ Metalliche - Vaschetta porta cancelleria inclusa/Metallic - Stationery tray included

L 33 - P 53 x H 35
805.CS.11.03_ Sospesa melaminico /Hanged melamine

L 32,5 P 52 x H 7
805.CA.01.04_ Sospesa metallica /Hanged metallic

Note: La finitura impiallacciato non è in pronta consegna. Per la disponibilità contattare l'ufficio commerciale. Per portacancelleria cassetti, vedi capitolo DV300-Accessori / Veneered finish is not in prompt delivery. Please contact the commercial department to check availability. For stationary tray, see chapter DV300-Accessories.

Tavoli riunione/Conference tables

H 74
805.TR.01.10_ Ø 100 805.TR.01.12_ Ø 120

L 200 P 100 x H 74
805.TR.32.20_ 805.TR.33.20_ 805.TR.02.20_ 805.TR.03.20_ 805.TR.32.24_ 805.TR.33.24_

L 240 P 120 x H 74
805.TR.02.24_ 805.TR.03.24_ 805.TR.34.25_ 805.TR.35.24_ 805.TR.04.25_ 805.TR.05.25_

Morsetti e supporti in per frontal panels Sp. 0,5 - 0,8 - 1 - 3/Clamps for frontal panels T. 0,5 - 0,8 - 1 - 3

300.FP.27.00 Per piani /For worktops 300.FP.28.00 Per piani-binari /For worktops-track 300.FP.30.00 Per gamba (serie DV805) /For leg (serie DV805) 300.FP.31.00 Per piano-gamba (serie DV805) /For worktop -leg (serie DV805) 300.FP.33.00 Free standing per piani /Free standing for worktops 300.FP.10.00 Per piani /For worktops 300.FP.22.00 Per piani-binari /For worktops-track 300.FP.23.00 Per gamba (serie DV805) /For leg (serie DV805) 300.FP.24.00 Per piano-gamba (serie DV805) /For worktop -leg (serie DV805) 300.FP.33.00 Free standing per piani /Free standing for worktops

Per frontal panels/For frontal panels FP1 FP65 FPP FP08 FPC1 FPC2

Frontal panels Sp. 0,8 - 1

P 1 x H 39
FP1

P 0,8 x H 39
FP08

300.FP.06.06_L 64 300.FP.06.07_L 79 300.FP.06.09_L 99 300.FP.06.11_L 119 300.FP.06.13_L 139 300.FP.06.15_L 159 300.FP.06.17_L 179 300.FP.06.19_L 199
Melaminico/Melamine

300.FPV1.06_L 64 300.FPV1.07_L 79 300.FPV1.09_L 99 300.FPV1.11_L 119 300.FPV1.13_L 139 300.FPV1.15_L 159 300.FPV1.17_L 179 300.FPV1.19_L 199
Vetro/Glass

Frontal panel tonoassorbenti Sp. 3 /Acoustic frontals panels T. 3

P 3 x H 39
FPC1

P 3 x H 59
FPC2

300.FP.40.06_L 64 300.FP.40.07_L 79 300.FP.40.09_L 99 300.FP.40.11_L 119 300.FP.40.13_L 139 300.FP.40.15_L 159 300.FP.40.17_L 179
Tessuto/Fabric

300.FP.50.13_L 139 300.FP.50.15_L 159
Tessuto/Fabric

Fontal panels H 65

P 1 x H 65
FP65

P 0,5 x H 65
FPP

300.FP.09.06_L 64 300.FP.09.07_L 79 300.FP.09.09_L 99 300.FP.09.11_L 119 300.FP.09.13_L 139 300.FP.09.15_L 159 300.FP.09.17_L 179 300.FP.09.19_L 199
Melaminico/Melamine

300.FP.69.06 L 64 300.FP.69.11 L 119 300.FP.69.13 L 139 300.FP.69.15 L 159
Plexiglass

N.B.: Per i frontal con lunghezza maggiore o uguale ai 139 cm, ordinare 2 kit di supporti per frontal panel / Note: For frontal panels with a length greater than or equal to 139 cm, order 2 kits of clamps-supports for frontal panels

Accessori per frontal panels in melaminico/Accessories for melamine frontal panels

L 6,5 P 6,5 x H 8,5 300.FA.01.01

L 50 P 17 x H 3 300.FA.02.05

L 31 P 22 x H 5 300.FA.04.03

L 23 P 10 x H 29 300.FA.06.02

L 35 P 6,5 x H 30 300.FA.08.03

Note: Il posizionamento degli accessori sui frontal panel in vetro prevede l'utilizzo di una guarnizione in PVC trasparente (Optional su richiesta)/Placement of accessories on glass front panel need the use of a transparent PVC gasket (Optional on request) - Non utilizzabile su frontal panels in plexiglass e frontal panels in tessuto fonoassorbente / Not usable for plexiglass frontal panels and acoustic frontal panels

Frontal panels con morsetti /Frontal panels with clamps

P 4 x H 59
300.FR.07.14 L 140 300.FR.07.16 L 160
Per piani/For worktops

Canalizzazione - Elettrificazione - Accessori/Wire management - Electrification - Accessories

300.AP.F1.00

300.CL.01.40

805.AP.32.01 Per "standing tables" H 107 con top access / For H107 "standing tables" with top access

300.AP.V1.00

300.APT2.01 Ø 8

300.AP.T7.01 Ø 6 300.APT8.01 Ø 8

805.AC.01.00 300.AC.06.05

805.KT.01.00 Kit per 2 gambe tavoli (optional) /Kit for 2 table legs (optional)

805.KT.02.00 Kit per 1 gamba intermedia (optional)/Kit for 1 table middle leg (optional)

300.AC.26.02 L 24,5 300.AC.26.03 L 34,5 300.AC.26.04 L 44,5

300.AC.25.02 L 23,5 300.AC.25.03 L 33,5 300.AC.25.04 L 43,5

300.APS1.02 L 20,5 300.APS1.03 L 30 300.APS1.04 L 42

300.AT.A6.02 L 21 300.AT.A6.03 L 25,5 300.AT.A6.04 L 39

300.AP.T8.11 300.AP.T8.14 300.AP.T8.17 300.AP.T8.20

300.APT4.01 300.APT5.01 - UK 300.APT6.01 - US

300.AC.38.02_H 2,4

300.AC.67.03 Marsupio per top access 300.AC.36_ 300.AC.38_ / Basket for top access 300.AC.36_ 300.AC.38_

Bracci porta video/Arms for video support

300.AC.04.01 Braccio porta video mobile su piano /Dynamic arm for video support on deskbase

300.AC.04.02 Doppio braccio porta video mobile su piano /2 dynamic arms for videosupport on deskbase

300.AC.03.01 Braccio porta video statico su palo /Static arm for video support on pole

300.AC.03.02 Doppio braccio porta video statico su palo /2 static arms for videosupport on pole

300.AC.02.01 Braccio porta video mobile su piano /Dynamic arm for video support on deskbase

300.AC.02.02 Doppio braccio porta video mobile su palo /2 dynamic arms for video support on deskbase

300.AC.01.01 Braccio porta video statico su palo /Static arm for video support on pole

300.AC.01.02 Doppio braccio porta video statico su palo /2 static arms for videosupport on pole

Note:

- Le dimensioni sono espresse in cm - consultare il listino prezzi per le caratteristiche tecniche, i codici degli articoli e delle finiture/Dimensions are stated in cm - for technical characteristics, article code numbers and finishing see price list;
- Prodotti non in pronta consegna. Per la disponibilità contattare l'ufficio commerciale/Items not in prompt delivery. Please contact the commercial department to check availability;
- Articoli prodotti solo su richiesta/Items produced only on demand;
- Fino ad esaurimento/Until exhaustion;
- Con serratura/With lock;
- Vetro/Glass.
- Plexiglass
- Morsetti o supporti in ABS /ABS clamps
- Morsetti o supporti in ZAMA / Zamak clamps

DV812 Enna

Design:
Antonio Morello

NEW

IT Design, stile e ampia flessibilità compositiva caratterizzano i tavoli di questa collezione. Le eleganti e minimali gambe free-standing, si abbinano a piani di lavoro dalle forme e dimensioni più diverse, così da poter creare configurazioni funzionali e personalizzate, sia per il lavoro individuale che quello di gruppo.

EN Design, style and wide compositional flexibility distinguish the tables in this collection. Functional and customized configurations both for individual and collective work environments can be created via the combination of elegant and minimal freestanding legs, combined to worktop of diverse shapes and dimensions.





















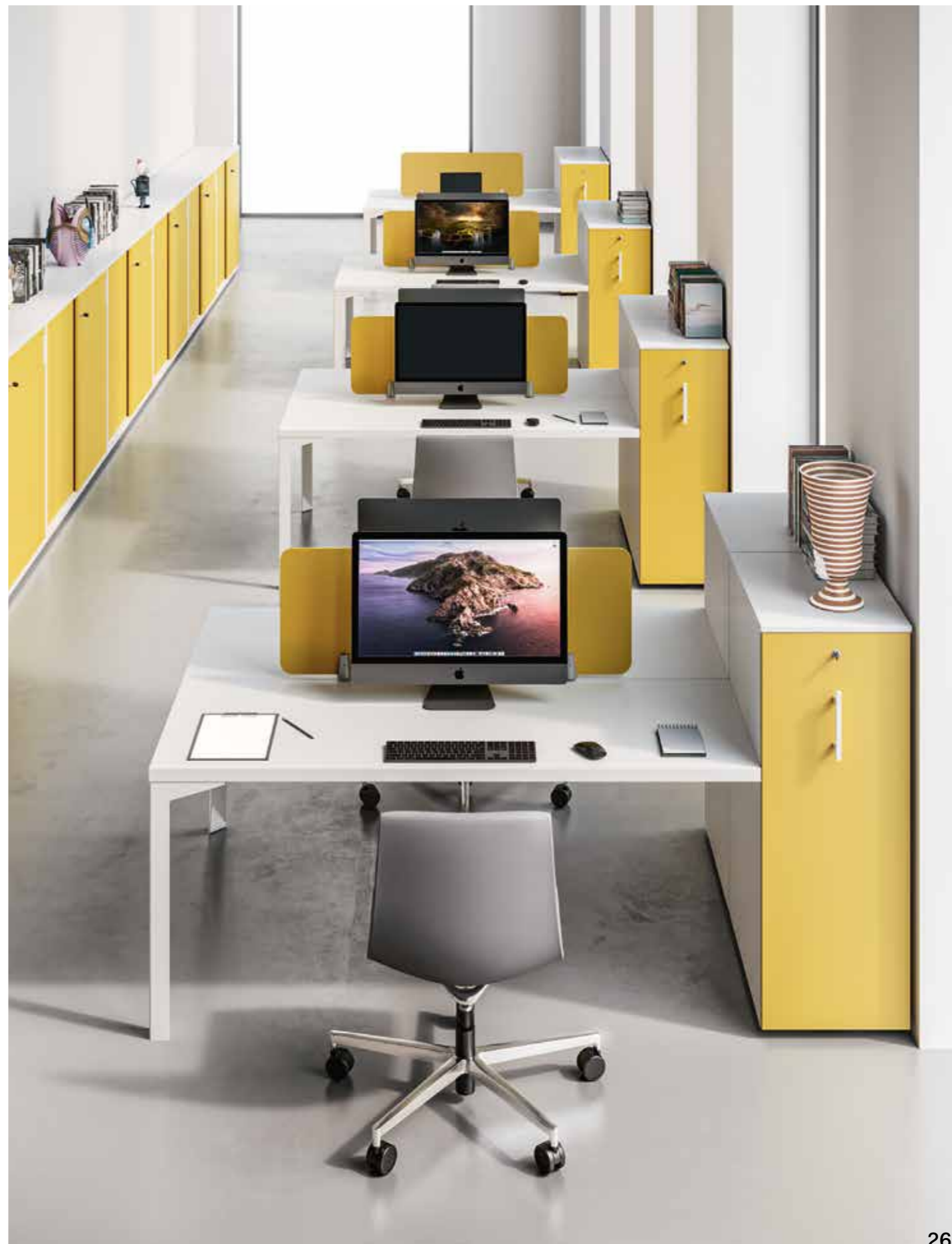

Tavoli/Tables

Piani di lavoro sp. 3.8 cm, in melaminico con bordi in ABS sp. 0.2 cm / Worktops 3.8 cm thick, in melamine with ABS edge-profiles 0.2 cm thick

Piano di lavoro effetto pelle sp. 3.8 cm (per tavoli P. 90 cm, tavoli sagomati e tavoli riunione - esclusi tavoli riunione rotondi) / Leather effect worktop 3.8 cm thick (for desk D.90 cm, shaped desks and meeting tables - round meeting tables are not included)

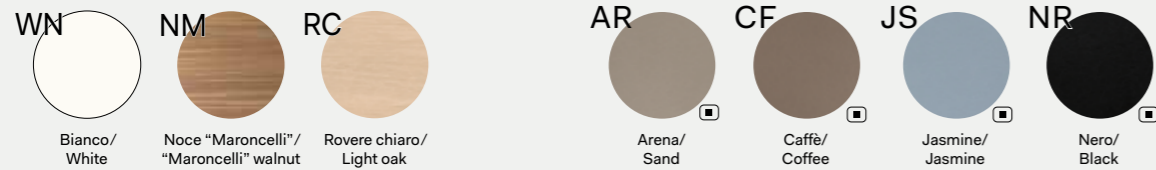

Modesty panel

Sp. 1.8 cm, in melaminico/18 mm thick, in melamine



Gambe metalliche/Metal legs

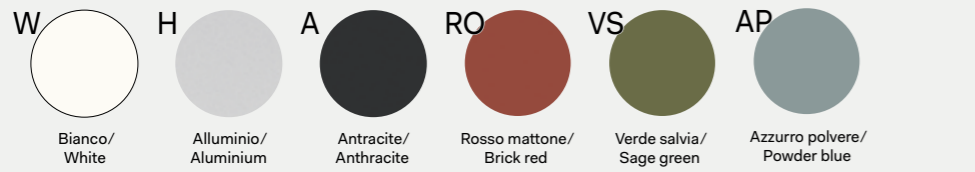

Carter chiuso e aperto / Casing closed and open



Mobili di servizio/Service units

Scocca e ripiani sp. 1.8 cm, in melaminico/ Bodies and shelves 1.8 cm thick, in melamine

Ante scorrevoli sp. 1.8 cm, in melaminico con bordo ABS sp. 0.15 cm colore alluminio/ Sliding doors 1.8 cm thick, in melamine with aluminium-coloured ABS edge-profiles 0.15 cm thick

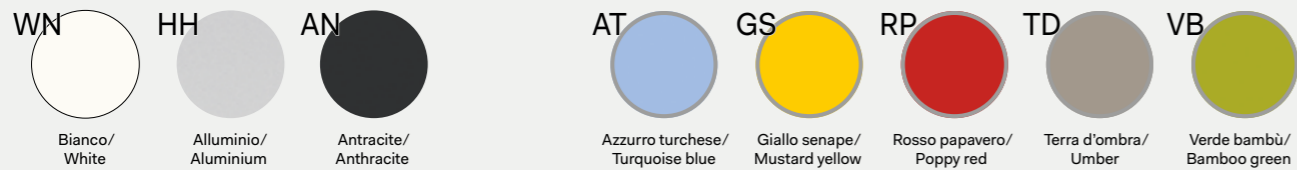

Ante scorrevoli sp. 1.8 cm, in melaminico con bordo ABS sp. 0.15 cm in tinta/Sliding doors 1.8 cm thick, in melamine with ABS edge-profiles 0.15 cm thick, in same color



Note

Per i colori e le finiture dei Frontal Panels, vedere il relativo capitolo in DV300 - Accessori. / For colours and finishes of Frontal Panels, see the chapter in DV300 - Accessories.
 ■ Prodotti non in pronta consegna. Per la disponibilità contattare l'ufficio commerciale./Items not in prompt delivery. Please contact the commercial department to check availability.

Piani di lavoro in melaminico sp. 38 mm con bordi perimetrali in ABS/Worktops in melamine 1 1/2" thick with perimetrical edges in ABS

Tavoli scrivanie/Desks

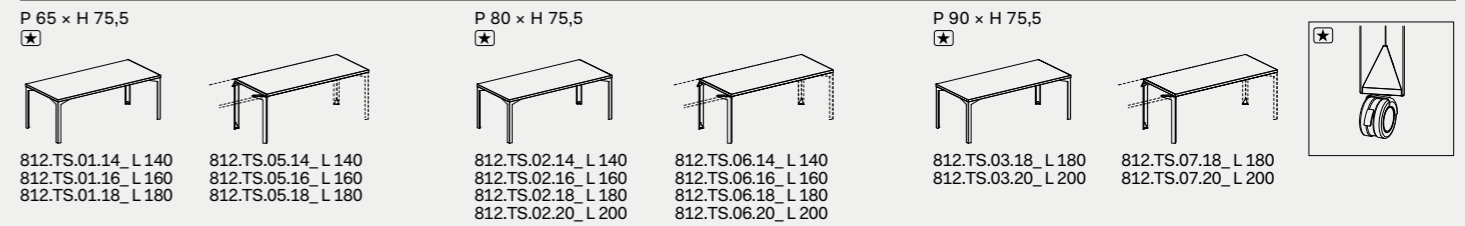

Tavoli alti H 107 / Standing tables H 107

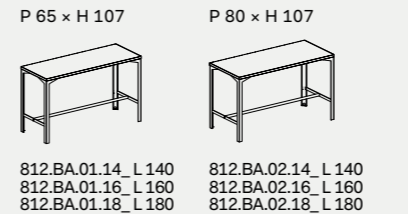

Tavoli scrivania sagomati / Shaped desks

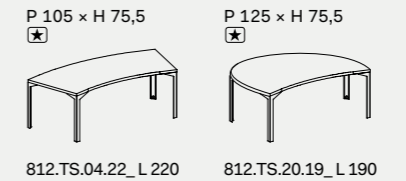

Allunghi laterali / Lateral extensions



Cassettiere portanti/Carrying pedestals

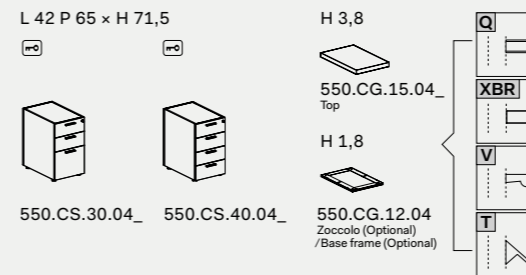

Contenitori H 75,5/Storage units H 75,5

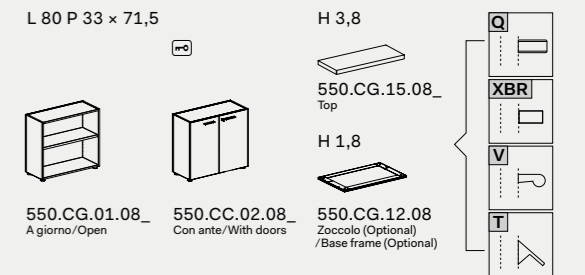

Tavoli a 2 scrivanie contrapposte/Benches

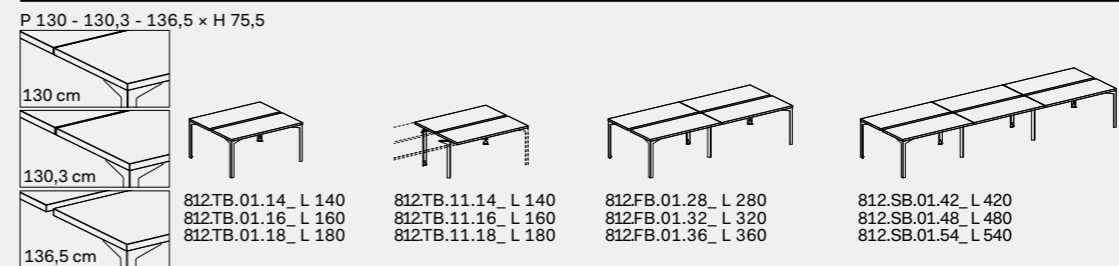

Tavoli a 2 scrivanie contrapposte + binario centrale / Benches + central rail

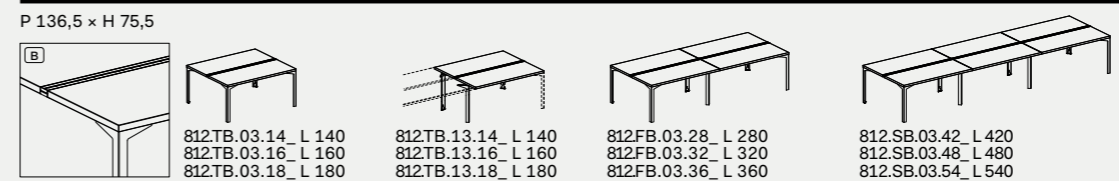

Tavoli scrivania con asole e 2 top access/Desks with opening and 2 top access

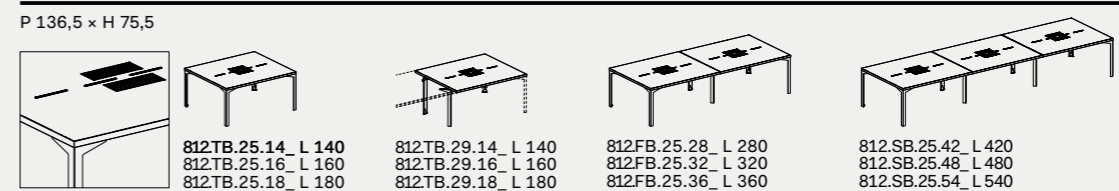

Note:

1 Le dimensioni sono espresse in cm - consultare il listino prezzi per le caratteristiche tecniche, i codici degli articoli e delle finiture/Dimensions are stated in cm - for technical characteristics, article code numbers and finishing see price list;
 B Con binario centrale/With central rail;
 S Con serratura/With lock;
 * I tavoli sono disponibili anche nella versione su ruote, consultare il listino per le varianti; /Tables are also available on wheels, see price list;

Piani di lavoro in melaminico sp. 38 mm con bordi perimetrali in ABS/Worktops in melamine 1 1/2" thick with perimetrical edges in ABS

Tavoli a 2 scrivanie contrapposte/Benches

P 160 - 160,3 - 166,5 x H 75,5

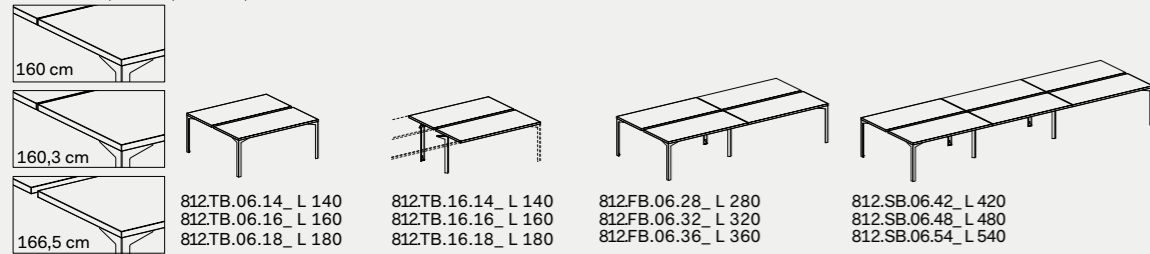

Tavoli a 2 scrivanie contrapposte + binario centrale/Benches + central rail

P 166,5 x H 75,5

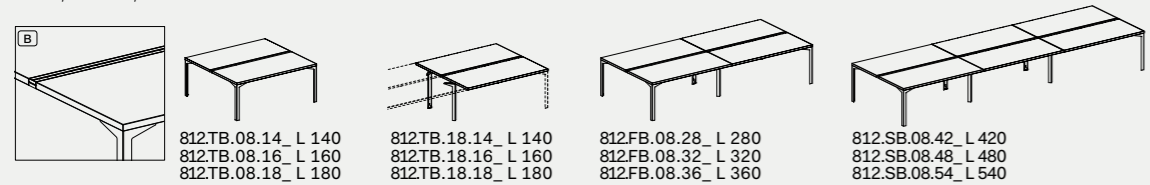

Tavoli scrivania per integrazioni /Integrable desks

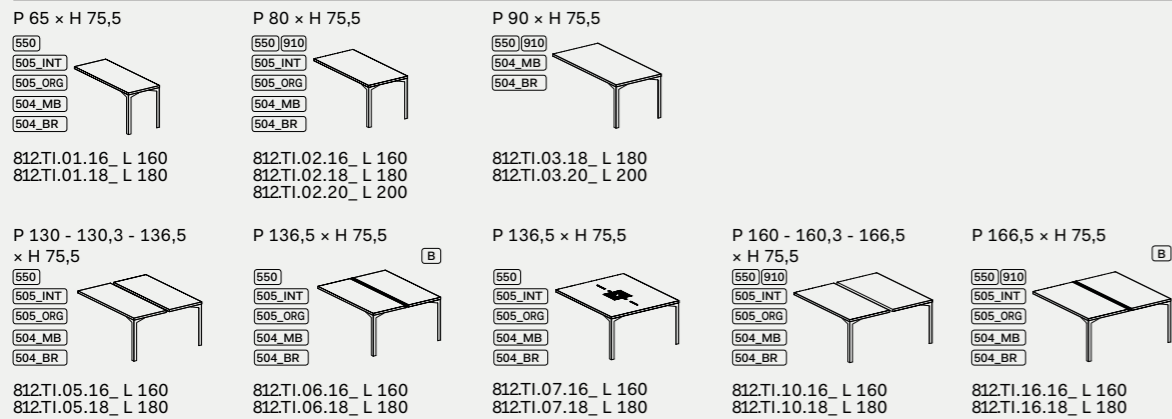

Note: Kit staffe da ordinare a parte, in base alla composizione da sviluppare / Brackets kit to be ordered separately, based on the composition to be developed

Tavoli sagomati integrabili su mobili di servizio/Integrable shaped desks for service units

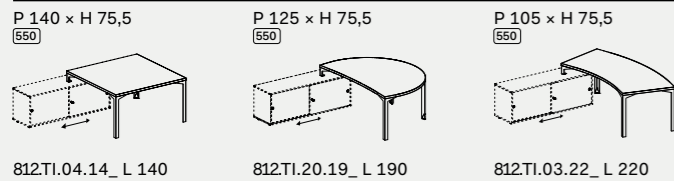

Note: Kit staffe per integrazione al mobile di servizio compreso nel codice / Brackets kit for integration to the service unit included in the code

Mobili di servizio con ante scorrevoli/Service units with sliding doors

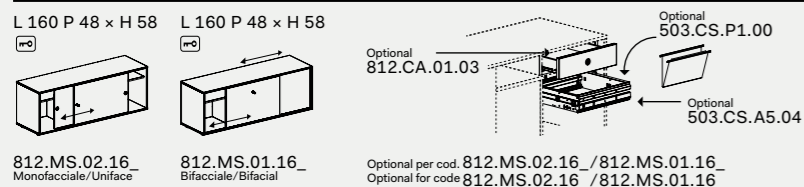

Kit supporto per fissaggio tavoli su mobile di servizio / Desk tables integration on service unit support kit

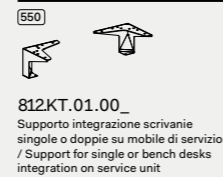

Note: [L] Con serratura/With lock; [B] Con binario centrale/With central rail; [550] Fissaggio su mobile di servizio / Service unit hooking; [910] Fissaggio su mobile multiuso DV910 / DV910 multipurpose unit hooking; [505_INT] Fissaggio su contenitori DV505 / DV505 storage unit hooking; [505_ORG] Fissaggio su orgatower DV505 / DV505 orgatower unit hooking; [504_MB] Fissaggio su moduli base DV504 / DV504 base modules hooking; [504_BR] Fissaggio su barra DV504 / DV504 metal bar hooking;

Piani di lavoro in melaminico sp. 38 mm con bordi perimetrali in ABS/Worktops in melamine 1 1/2" thick with perimetrical edges in ABS

Composizioni con tavoli integrabili su mobili di servizio/Compositions with integrable desks for service units [550]

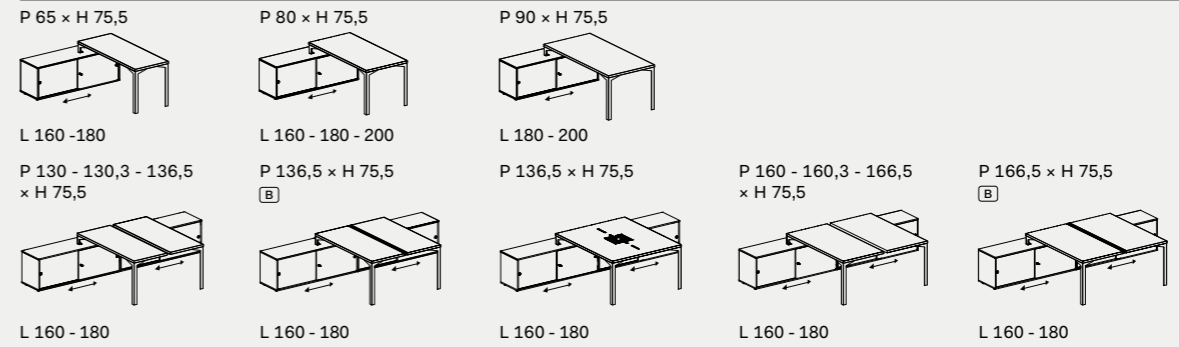

Note: Per le composizioni con tavoli scrivania su mobili di servizio ordinare sempre il kit Cod. 812.KT.01.00, il tavolo integrabile scelto e il mobile di servizio / For compositions with desk tables on service unit, always order the kit Cod. 812.KT.01.00, the chosen integrable table and the service unit

Kit supporto per fissaggio tavoli su mobile multifunzione DV910 / Desk tables integration on DV910 multi-purpose storage unit

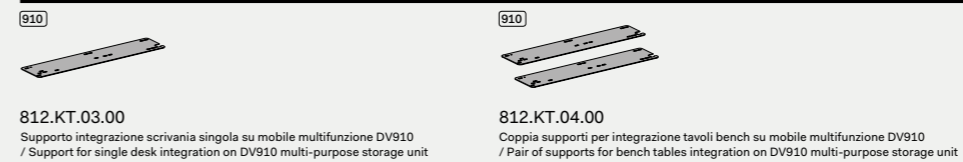

Composizioni con tavoli integrabili a mobile multifunzione DV910/Compositions with integrable desks on DV910 multi-purpose storage unit [910]

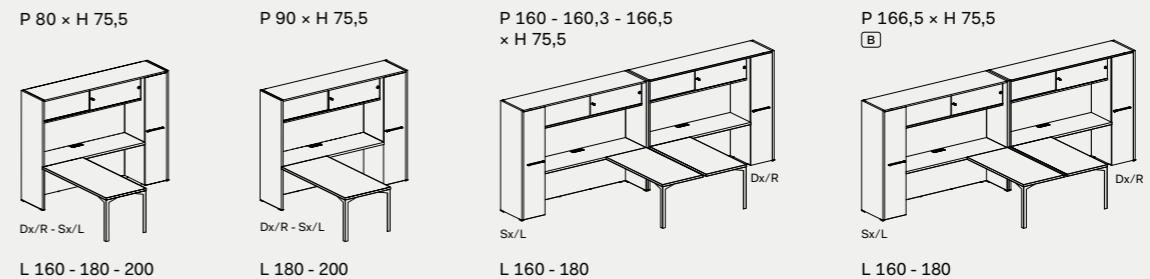

Note: Ordinare sempre il kit Cod. 812.KT.03.00 per i tavoli singoli e il kit Cod. 812.KT.04.00 per i tavoli bench / Always order the kit Cod. 812.KT.03.00 for single desk tables and the kit Cod. 812.KT.04.00 for bench tables. Ordinare a parte il mobile multifunzione e relativi accessori, consultare il listino DV910/Order the multifunctional storage unit and related accessories separately, see the DV910 price list

Kit supporto per fissaggio tavoli su contenitori integrati DV505 H= 75,5, 116,5, 166 / Desk tables on integrated storage unit DV505 H= 75,5, 116,5, 166



Composizioni con tavoli integrabili a contenitori DV505 H= 75,5, 116,5, 166 [505_INT] / Compositions with integrable desks on storage unit DV505 H= 75,5, 116,5, 166

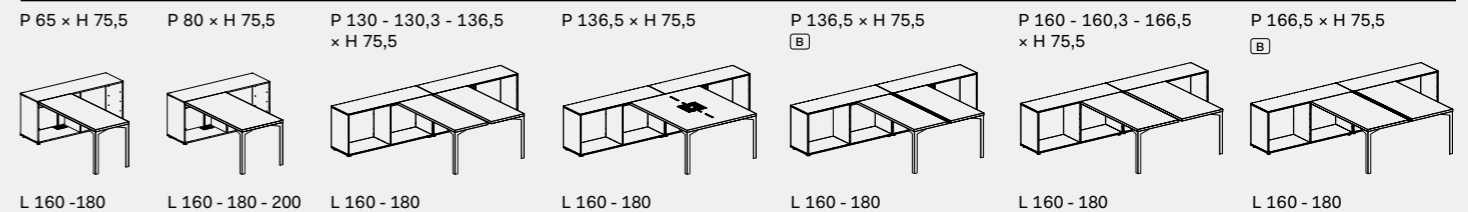

Note: Ordinare sempre il kit Cod. 812.KT.05.00 per i tavoli singoli e il kit Cod. 812.KT.06.00 per i tavoli bench / Always order the kit Cod. 812.KT.05.00 for single desk tables and the kit Cod. 812.KT.06.00 for bench tables. Ordinare a parte i moduli contenitori integrati H 75,5, 116,5, 166 e relativi accessori, consultare il listino DV505/Order the H = 75,5 - 116,5 - 166 integrated storage unit and related accessories separately, see DV505 price list

Note: [L] Le dimensioni sono espresse in cm - consultare il listino prezzi per le caratteristiche tecniche, i codici degli articoli e delle finiture / Dimensions are stated in cm - for technical characteristics, article code numbers and finishing see price list; [B] Con binario centrale/With central rail; [550] Fissaggio su mobile di servizio / Service unit hooking; [910] Fissaggio su mobile multiuso DV910 / DV910 multipurpose unit hooking; [505_INT] Fissaggio su contenitori DV505 / DV505 storage unit hooking;

Piani di lavoro in melaminico sp. 38 mm con bordi perimetrali in ABS/Worktops in melamine 1 1/2" thick with perimetrical edges in ABS

Kit supporto per fissaggio tavoli su orgatower H= 115 DV505 / Desk tables integration on orgatower H= 115 DV505 support kit

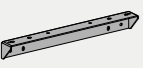
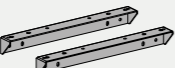

 812.KT.07.00 Supporto integrazione scrivania singola su orgatower H= 115 DV505 / Support for single desk integration on orgatower H= 115 DV505	 812.KT.08.00 Coppia supporti per integrazione tavoli bench su orgatower H= 115 DV505 / Pair of supports for bench tables integration on orgatower H= 115 DV505
---	--

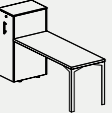
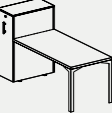
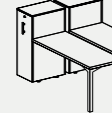
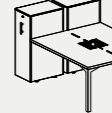
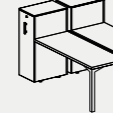
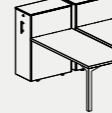
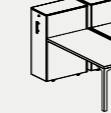
Composizioni con tavoli integrabili a orgatower H= 115 DV505 / Compositions with integrable desks on orgatower H= 115 DV505 505_ORG

 L 160 -180	 L 160 -180 -200	 L 160 -180	 L 160 -180	 L 160 -180	 L 160 -180	 L 160 -180
--	--	---	---	---	--	---

Note: Ordinare sempre il kit Cod. 812.KT.07.00 per i tavoli singoli e il kit Cod. 812.KT.08.00 per i tavoli bench / Always order the kit Cod. 812.KT.07.00 for single desk tables and the kit Cod. 812.KT.08.00 for bench tables
Ordinare a parte gli orgatower H= 115 e relativi accessori, consultare il listino DV505/Order the H= 115 orgatower and related accessories separately, see DV505 price list

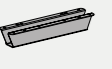
Kit supporto per fissaggio tavoli su moduli tecnici (DV504) / Desk tables integration on technical modules (DV504)

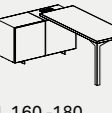
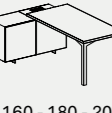
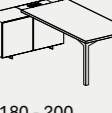
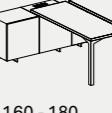
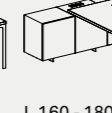
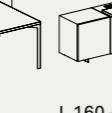
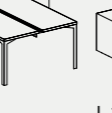
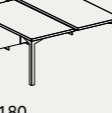

 812.KT.09.00 Supporto integrazione scrivania singola su moduli tecnici (DV504) / Support for single desk integration on technical modules (DV504)	 812.KT.10.00 Coppia supporti per integrazione tavoli bench su moduli tecnici (DV504) / Pair of supports for bench tables integration on technical modules (DV504)
--	---

Composizioni con tavoli integrabili su moduli tecnici (DV504)/Compositions with integrable desks on technical modules (DV504) 504_MB





 L 160 -180	 L 160 -180 -200	 L 180 -200	 L 160 -180	 L 160 -180	 L 160 -180	 L 160 -180	 L 160 -180
--	--	---	---	---	---	--	---

Note: Ordinare sempre il kit Cod. 812.KT.09.00 per i tavoli singoli e il kit Cod. 812.KT.10.00 per i tavoli bench / Always order the kit Cod. 812.KT.09.00 for single desk tables and the kit Cod. 812.KT.10.00 for bench tables
Ordinare a parte i moduli tecnici e i relativi accessori, consultare il listino DV504/Order the technical modules and related accessories separately, see DV504 price list

Kit supporto per fissaggio tavoli su barra (DV504)/ Desk tables integration on bar (DV504)

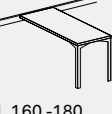
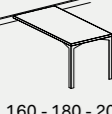
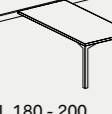
 812.KT.11.00 Supporto integrazione scrivania singola su barra (DV504) / Support for single desk integration on bar (DV504)	 812.KT.12.00 Coppia supporti per integrazione tavoli bench su barra (DV504) / Pair of supports for bench tables integration on bar (DV504)
---	--

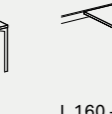
Composizioni con tavoli integrabili su barra (DV504)/Compositions with integrable desks on bar (DV504) 504_BR

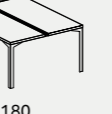
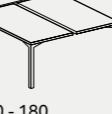
 L 160 -180	 L 160 -180 -200	 L 180 -200	 L 160 -180	 L 160 -180	 L 160 -180	 L 160 -180	 L 160 -180
--	--	---	---	---	---	--	---

Note: Ordinare sempre il kit Cod. 812.KT.11.00 per i tavoli singoli e il kit Cod. 812.KT.12.00 per i tavoli bench / Always order the kit Cod. 812.KT.11.00 for single desk tables and the kit Cod. 812.KT.12.00 for bench tables
Ordinare a parte la barra a muro e i relativi accessori, consultare il listino DV504/Order the wall bar and related accessories separately, see DV504 price list







Note:

■ Prodotti non in pronta consegna. Per la disponibilità contattare l'ufficio commerciale/Items not in prompt delivery. Please contact the commercial department to check availability;

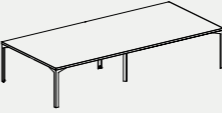
ⓑ Con binario centrale/With central rail;

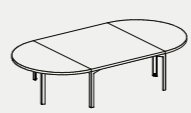
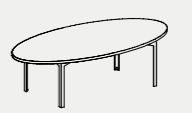
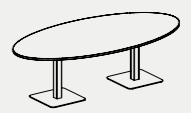

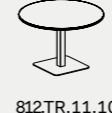

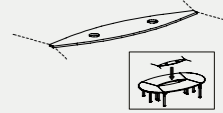

505_ORG Fissaggio su orgatower DV505 / DV505 orgatower unit hooking;
 504_MB Fissaggio su moduli base DV504 / DV504 base modules hooking;
 504_BR Fissaggio su barra DV504 / DV504 metal bar hooking;

Tavolo riunioni/Conference tables

 812TR.40.24_ L 240 P 120 x H 75,5	 812TR.39.14_ L 140 P 140 x H 75,5	 812TR.75.28_ L 280 P 140 x H 75,5	 812TR.34.25_ L 250 P 125 x H 75,5	 812TR.05.25_ L 250 P 125 x H 75,5
 812TR.04.25_ L 250 P 125 x H 75,5	 812TR.11.10_ ø 100 812TR.11.12_ ø 120 H 75,5	 812TR.01.10_ ø 100 812TR.01.12_ ø 120 H 75,5	 812TR.75.36_ L 365,7 P 215,5 x H 75,5	 812PR.75.17_ L 172,8 P 35 x H 3,8

Note: Ordinare a parte due torrette elettrificate 300.AP.T_01 /Order two wires torres 300.AP.T_01 separately

Cassettiere/Pedestals

 550.CS.10.04_ Melaminico/Melamine	 550.CS.20.04_ Melaminico/Melamine	 550.CS.1M.03_ Metalliche/Metallic	 550.CS.2M.03_ Metalliche/Metallic	 550.CS.1M.04_ Metalliche - Vaschetta porta cancelleria inclusa/Metallic - Stationery tray included	 550.CS.2M.04_ Metalliche - Vaschetta porta cancelleria inclusa/Metallic - Stationery tray included
---	---	---	---	--	--

Note: La finitura impiallacciato non è in pronta consegna. Per la disponibilità contattare l'ufficio commerciale. Per portacancelleria cassetti, vedi capitolo DV300-Accessori /Veneered finishes is not in prompt delivery. Please contact the commercial department to check availability. For stationary tray, see chapter DV300-Accessories.

Cassettiere sospese /Hanged pedestals

 812.CA.01.05 Sospesa metallica /Hanged metallic

Note: Per portacancelleria cassetti, vedi capitolo DV300-Accessori /For stationary tray, see chapter DV300-Accessories

Accessori su binari/Accessories on rail

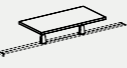
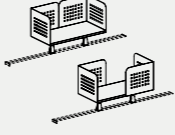
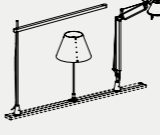
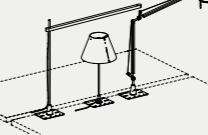
 812.AB.03.06 L 60 P 30 x H 1,8	 812.AB.04.06 L 60 P 30 x H 26,5	 812.AB.01.00	 812.AB.01.01 Per bench P= 136,5 - 166,5 /For benches P= 136,5 - 166,5
--	---	---	---

Porta dox/Top box

 300.AC.15.06 Metallico/Metallic L 80 P 40 x H 40

Modesty panels

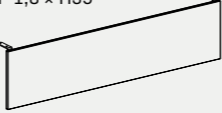
 812.MP.01.12_ L 87 812.MP.01.14_ L 107 812.MP.01.16_ L 127 812.MP.01.18_ L 147 812.MP.01.20_ L 167 Per tavoli/For desks

Bracci porta video/Arms for video support

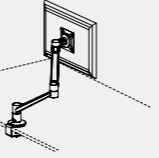
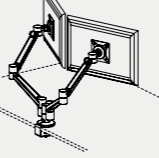
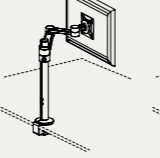
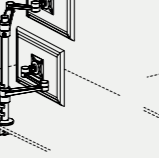
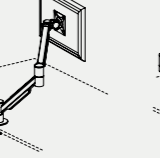
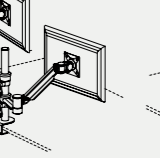
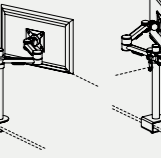
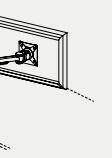
 300.AC.04.01 Braccio porta video mobile su piano /Dynamic arm for video support on deskbase	 300.AC.04.02 Doppio braccio porta video mobile su piano /2 dynamic arms for video support on deskbase	 300.AC.03.01 Braccio porta video statico su palo /Static arm for video support on deskbase	 300.AC.03.02 Doppio braccio porta video statico su palo /2 static arms for video support on pole	 300.AC.02.01 Braccio porta video mobile su piano /Dynamic arm for video support on deskbase	 300.AC.02.02 Doppio braccio porta video mobile su piano /2 dynamic arms for video support on deskbase	 300.AC.01.01 Braccio porta video statico su palo /Static arm for video support on pole	 300.AC.01.02 Doppio braccio porta video statico su palo /2 static arms for video support on pole
---	---	--	--	---	---	--	--

Note:

1 Le dimensioni sono espresse in cm - consultare il listino prezzi per le caratteristiche tecniche, i codici degli articoli e delle finiture/Dimensions are stated in cm - for technical characteristics, article code numbers and finishing see price list;

■ Prodotti non in pronta consegna. Per la disponibilità contattare l'ufficio commerciale/Items not in prompt delivery. Please contact the commercial department to check availability;

☑ Con serratura/With lock;

Frontal panels Sp. 0,8 - 1

P 1 x H 39



300.FP.06.06_L 64
300.FP.06.07_L 79
300.FP.06.09_L 99
300.FP.06.11_L 119
300.FP.06.13_L 139
300.FP.06.15_L 159
300.FP.06.17_L 179
300.FP.06.19_L 199
Melaminico/Melamine

P 0,8 x H 39



300.FPV1.06_L 64
300.FPV1.07_L 79
300.FPV1.09_L 99
300.FPV1.11_L 119
300.FPV1.13_L 139
300.FPV1.15_L 159
300.FPV1.17_L 179
300.FPV1.19_L 199
Vetro/Glass

Frontal panel fonoassorbenti Sp. 3 / Acoustic frontals panels T. 3

P 3 x H 39

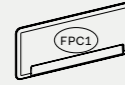

300.FP.40.06_L 64
300.FP.40.07_L 79
300.FP.40.09_L 99
300.FP.40.11_L 119
300.FP.40.13_L 139
300.FP.40.15_L 159
300.FP.40.17_L 179
Tessuto/Fabric

P 3 x H 59



300.FP.50.13_L 139
300.FP.50.15_L 159
Tessuto/Fabric

Fontal panels H 65

P 1 x H 65



300.FP.09.06_L 64
300.FP.09.07_L 79
300.FP.09.09_L 99
300.FP.09.11_L 119
300.FP.09.13_L 139
300.FP.09.15_L 159
300.FP.09.17_L 179
300.FP.09.19_L 199
Melaminico/Melamine

P 0,5 x H 65



300.FP.69.06_L 64
300.FP.69.11_L 119
300.FP.69.13_L 139
300.FP.69.15_L 159
Plexiglass

★ N.B.: Per i frontal con lunghezza maggiore o uguale ai 139 cm, ordinare 2 kit di supporti per frontal panel / Note: For frontal panels with a length greater than or equal to 139 cm, order 2 kits of clamps-supports for frontal panels

Staffe e supporti per frontal panels Sp. 0,5 - 0,8 - 1 - 3 / Brackets and clamps for frontal panels T. 0,5 - 0,8 - 1 - 3

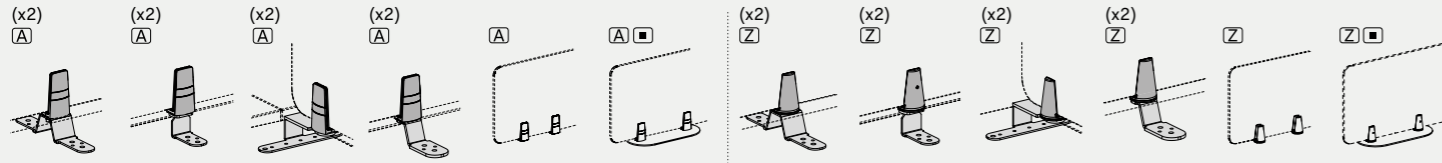

812.FP.91.01 Supporto per bench P=136,5 - 166,5 / Bracket for bench D= 136,5 - 166,5

812.FP.91.02 Supporto per bench P=130,3 - 160,3 / Bracket for bench D= 130,3 - 160,3

812.FP.91.03 Supporto per piani / Bracket for worktops

812.FP.91.04 Supporto inclinato per piani / Inclined bracket for worktops

300.FP.28.00 Per piani-binari / For worktops -tracks

300.FP.33.00 Free standing per piani / Free standing for worktops

812.FP.91.01 Supporto per bench P=136,5 - 166,5 / Bracket for bench D= 136,5 - 166,5

812.FP.91.02 Supporto per bench P=130,3 - 160,3 / Bracket for bench D= 130,3 - 160,3

812.FP.91.03 Supporto per piani / Bracket for worktops

812.FP.91.04 Supporto inclinato per piani / Inclined bracket for worktops

300.FP.22.00 Per piani-binari / For worktops -track

300.FP.33.00 Free standing per piani / Free standing for worktops

Per frontal panels / For frontal panels

Accessori per frontal panels in melaminico / Accessories for melamine frontal panels

L 6,5 P 6,5 x H 8,5

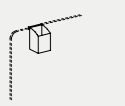

300.FA.01.01

L 50 P 17 x H 3

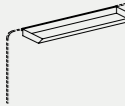

300.FA.02.05

L 31 P 22 x H 5

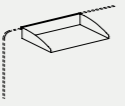

300.FA.04.03

L 23 P 10 x H 29

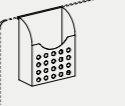

300.FA.06.02

L 35 P 6,5 x H 30

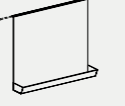

300.FA.08.03

Note: Il posizionamento degli accessori sui frontal panel in vetro prevede l'utilizzo di una guarnizione in PVC trasparente (Optional su richiesta) / Placement of accessories on glass front panel need the use of a transparent PVC gasket (Optional on request)
Non utilizzabile su frontal panels in plexiglass e frontal panels in tessuto fonoassorbente / Not usable for plexiglass frontal panels and acoustic frontal panels

Frontal panel speciale / Special frontal panel

P 3

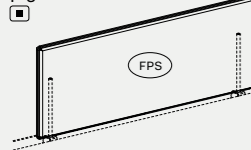

300.FR.10.08 L 80 x H 30
300.FR.60.14 L 140 x H 42,5

Supporti per frontal panel speciali / Bracket for special frontal panels

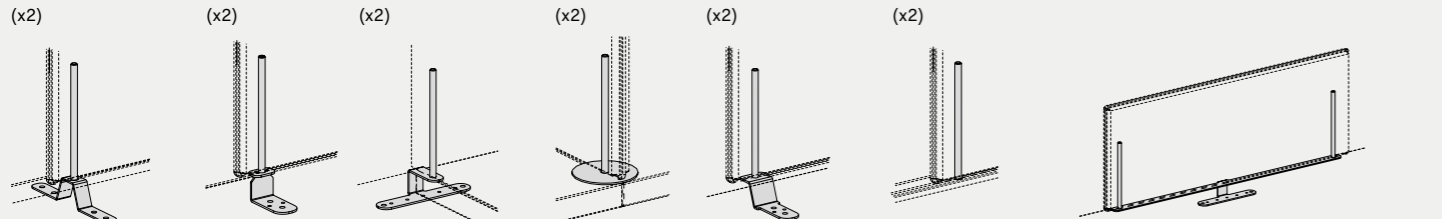

812.FP.92.01 Supporto frontal speciali per bench P=136,5 - 166,5 / Special frontal panels bracket for bench D= 136,5 - 166,5

812.FP.92.02 Supporto frontal speciali per bench P=130,3 - 160,3 / Special frontal panels bracket for bench D= 130,3 - 160,3

812.FP.92.03 Supporto "flessibile" per frontal panel speciali / "Flexible" bracket for special frontal panels

812.FP.92.05 Supporto "flessibile" per frontal panel speciali / "Flexible" bracket for special frontal panels

812.FP.92.07 Supporto inclinato frontal panel speciali / Inclined bracket for special frontal panels

812.FP.92.08 Supporto per binario frontal panel speciali / Bracket for central rail for special frontal panels

812.FP.92.06 Supporto per frontal panel speciale L=80 / Bracket for special frontal panel W=80

Per frontal panels / For frontal panels

Note:

1 Le dimensioni sono espresse in cm - consultare il listino prezzi per le caratteristiche tecniche, i codici degli articoli e delle finiture / Dimensions are stated in cm - for technical characteristics, article code numbers and finishing see price list;

2 Prodotti non in pronta consegna. Per la disponibilità contattare l'ufficio commerciale / Items not in prompt delivery. Please contact the commercial department to check availability;

3 Vetro/Glass; 4 Plexiglass

5 Morsetti o supporti in ABS / ABS clamps
6 Morsetti o supporti in ZAMA / Zamak clamps

Canalizzazione - Elettrificazione - Accessori / Wire management - Electrification - Accessories

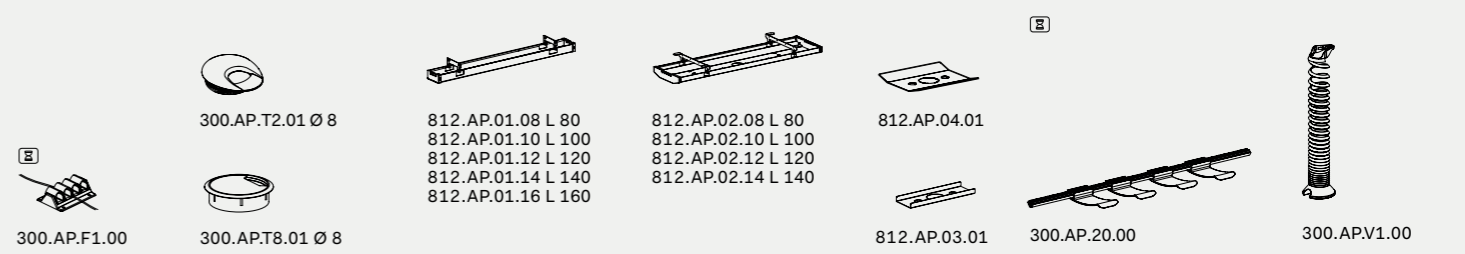

300.AP.T2.01 Ø 8

812.AP.01.08 L 80
812.AP.01.10 L 100
812.AP.01.12 L 120
812.AP.01.14 L 140
812.AP.01.16 L 160

812.AP.02.08 L 80
812.AP.02.10 L 100
812.AP.02.12 L 120
812.AP.02.14 L 140

812.AP.04.01

812.AP.03.01

300.AP.20.00

300.AP.V1.00

300.AP.F1.00

300.AP.T8.01 Ø 8

L 32 x P 12,3

300.AC.26.02 L 24,5
300.AC.26.03 L 34,5
300.AC.26.04 L 44,5

300.AP.S1.02 L 20,5
300.AP.S1.03 L 30
300.AP.S1.04 L 42
Per / For top access 300.AC.26...

300.AC.38.03_H 3

300.AC.67.03
Marsupio per top access
300.AC.36... 300.AC.38...
/ Basket for top access
300.AC.36... 300.AC.38...

300.AT.A6.02 L 21
300.AT.A6.03 L 25,5
300.AT.A6.04 L 39

300.APT4.01
300.APT5.01 - UK
300.APT6.01 - US

300.AC.16.02

300.AC.06.05

812.AC.06.00
Cinghie porta Cpu
/ Cpu holder straps

812.AC.01.00
Staffa e cinghie porta Cpu
/ Bracket and cpu holder straps

L 6,6 P 1,7 x H 63

L 6,6 P 1,7 x H 59

L 6,6 P 1,7 x H 94

L 6,6 P 1,7 x H 5,5

L 13 P 6,2 x H 0,5

812.AP.08.00_ Carter gamba / Carter leg

812.AP.08.03_ Carter gamba con ruota / Carter for leg with wheel

812.AP.08.05_ Carter gamba tavoli alti / Carter for high tables leg

812.AP.08.07_ Carter per supporto per mobile di servizio / Carter for service unit support

812.AC.07.01 Carter per omega bench / Carter for bench's omega

812.GC.01.05 Coppia carter per gamba intermedia P= 130 / 130,3 / 136,5 / 160 / 160,3 / 166,5 / Pair of casings for middle leg D= 130 / 130,3 / 136,5 / 160 / 160,3 / 166,5

Ø 8

300.AP.T8.11
300.AP.T8.12 - UK
300.AP.T8.13 - US
Tappo con 1 presa elettrica + USB (solo ricarica) + passacavo / Plug with 1 electrical socket + USB (only charge) + outlet lid

300.AP.T8.14
300.AP.T8.15 - UK
300.AP.T8.16 - US
Tappo con 1 presa elettrica + USB (solo ricarica) + HDMI / Plug with 1 electrical socket + USB (only charge) + HDMI

300.AP.T8.17
300.AP.T8.18 - UK
300.AP.T8.19 - US
Tappo con 1 presa elettrica + USB (solo ricarica) + RJ45 / Plug with 1 electrical socket + USB (only charge) + RJ45

300.AP.T8.20
300.AP.T8.21 - UK
300.AP.T8.22 - US
Tappo con 1 presa elettrica + USB (solo ricarica) + USB dati / Plug with 1 electrical socket + USB (only charge) + USB data

L 5 P 3 x H 5

812.AC.08.01
812.AC.08.01 - UK
812.AC.08.01 - US
Presa USB (solo ricarica) / USB Socket (only charge)

Note:

1 Le dimensioni sono espresse in cm - consultare il listino prezzi per le caratteristiche tecniche, i codici degli articoli e delle finiture / Dimensions are stated in cm - for technical characteristics, article code numbers and finishing see price list;

2 Per la scelta dei contenitori e degli accessori vari, consultare il relativo listino o catalogo / To choose storage units and accessories, please check correspondent price list or catalogue;

3 Fino ad esaurimento / Until exhaustion;

4 Prodotti non in pronta consegna. Per la disponibilità contattare l'ufficio commerciale / Items not in prompt delivery. Please contact the commercial department to check availability;

5 Articoli prodotti solo su richiesta / Items produced only on demand;

DV816 Nida

Design:
Antonio Morello

NEW

IT Eleganti e colorati, gli scrittoi della serie DV816-Nida si distinguono per stile, leggerezza e contemporaneità. Dedicati e creati soprattutto per l'homeoffice, essi sono estremamente funzionali, si montano con facilità e sono disponibili con gambe in tubolare metallico oppure coniche in legno. Accessori, piccole mensole e cassetti sottopiano, permettono di personalizzare lo scrittoio secondo le proprie esigenze.

EN Elegant and colourful, the DV816-Nida writing desks stand out for their style, lightness and modernity. Studied and created especially for the home office, they are extremely functional, easy to assemble and are available with metal tubular legs or conical wooden legs. Accessories, small shelves and under top drawers, allow you to customize the desk according to your needs.



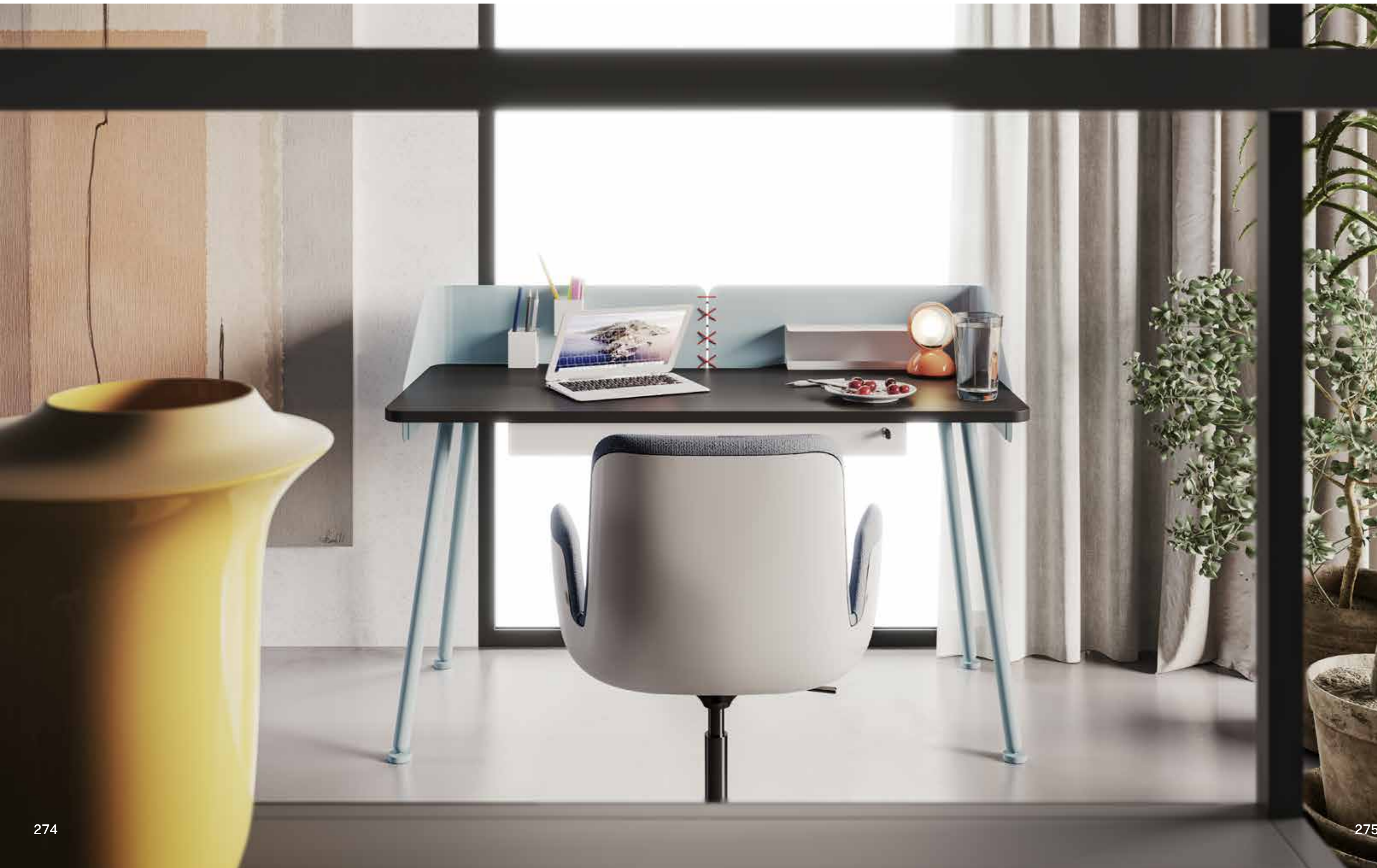



Tavoli/Tables

Piani di lavoro sp. 2.5 cm, in melaminico con bordi in ABS sp. 0.2 cm/Worktops 2.5 cm thick, in melamine with ABS edge-profiles 0.2 cm thick



Strutture e schermi in metallo / Metal structures and screens

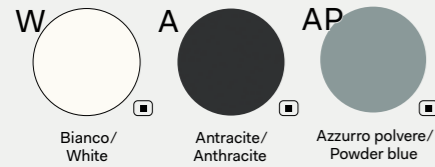

Gambe in legno/Wooden legs



Cassetti metallici e accessori/Metal drawers and accessories

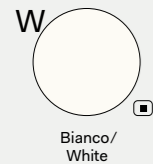

Cordoncino elastico/Elastic cord



Note

Per i colori e le finiture dei Frontal Panels, vedere il relativo capitolo in DV300 - Accessori. / For colours and finishes of Frontal Panels, see the chapter in DV300 - Accessories.
 ■ Prodotti non in pronta consegna. Per la disponibilità contattare l'ufficio commerciale./Items not in prompt delivery. Please contact the commercial department to check availability.

Piani di lavoro in melaminico sp. 25 mm con bordi perimetrali in ABS/Worktops in melamine 25 mm thick with perimetrical edges in ABS

Tavoli scrivania home office / Home office desks

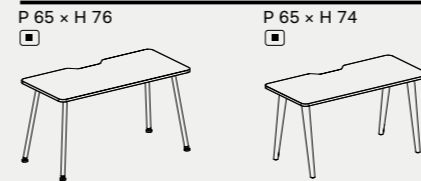

816.TS.01.14_L 140
Con gambe metalliche /With metal legs
816.TS.01.14_L 140
Con gambe coniche in legno /With wooden conic legs

Tavoli scrivanie home office con schermi metallici / Home office desks with metal screens

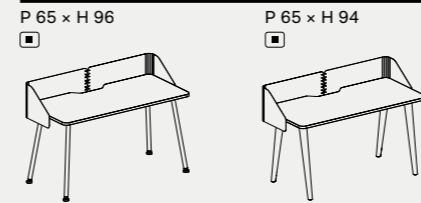

816.TS.91.14_L 140
Con gambe metalliche /With metal legs
816.TS.91.14_L 140
Con gambe coniche in legno /With wooden conic legs

Accessori per piano / Accessories for worktop

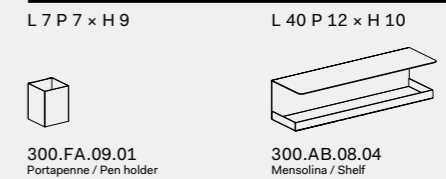

300.FA.09.01
Portapenne / Pen holder

300.AB.08.04
Mensolina / Shelf

Cassettiere/Pedestals

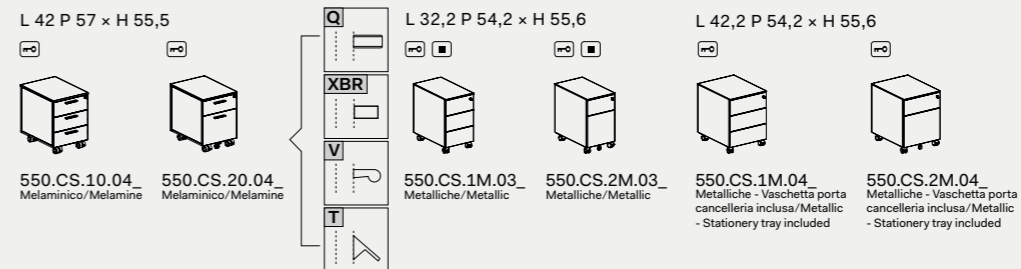

L 42 P 57 x H 55,5

550.CS.10.04 Melaminico/Melamine
550.CS.20.04 Melaminico/Melamine

L 32,2 P 54,2 x H 55,6

550.CS.1M.03 Metalliche/Metallic
550.CS.2M.03 Metalliche/Metallic

L 42,2 P 54,2 x H 55,6

550.CS.1M.04 Metalliche - Vaschetta porta cancelleria inclusa/Metallic - Stationery tray included
550.CS.2M.04 Metalliche - Vaschetta porta cancelleria inclusa/Metallic - Stationery tray included

Cassetti metallici / Metallic drawer

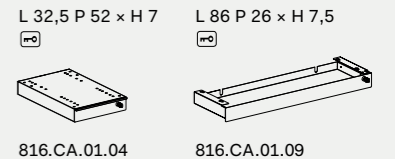

816.CA.01.04

816.CA.01.09

Note: La finitura impiallacciato non è in pronta consegna. Per la disponibilità contattare l'ufficio commerciale. Per portacancelleria cassetti, vedi capitolo DV300-Accessori /Veneered finish is not in prompt delivery. Please contact the commercial department to check availability. For stationary tray, see chapter DV300-Accessories.

Morsetti e supporti per frontal panels sp. 3 - sp. 1 - sp. 0,8 /Clamps for frontal panels t. 3 - t. 1 - t. 0,8

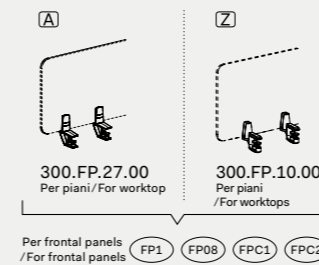

300.FP.27.00 Per piani /For worktop
300.FP.10.00 Per piani /For worktops

Per frontal panels /For frontal panels FP1 FP08 FPC1 FPC2

Frontal panels sp. 1 - sp. 0,8

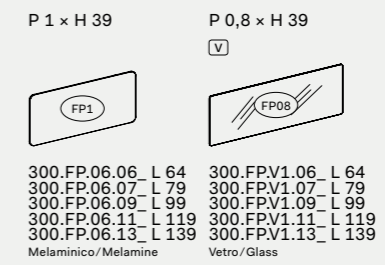

300.FP.06.06_L 64
300.FP.06.07_L 79
300.FP.06.09_L 99
300.FP.06.11_L 119
300.FP.06.13_L 139
300.FP.V1.06_L 64
300.FP.V1.07_L 79
300.FP.V1.09_L 99
300.FP.V1.11_L 119
300.FP.V1.13_L 139
Melaminico/Melamine Vetro/Glass

Frontal panel fonoassorbenti sp. 3 /Acoustic frontals panels t. 3

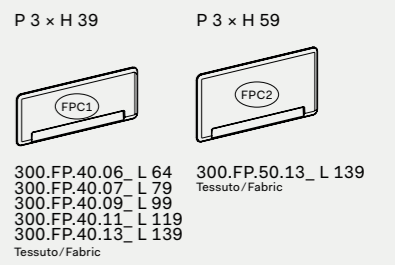

300.FP.40.06_L 64
300.FP.40.07_L 79
300.FP.40.09_L 99
300.FP.40.11_L 119
300.FP.40.13_L 139
Tessuto/Fabric

Canalizzazione - Elettrificazione - Accessori/Wire management - Electrification - Accessories

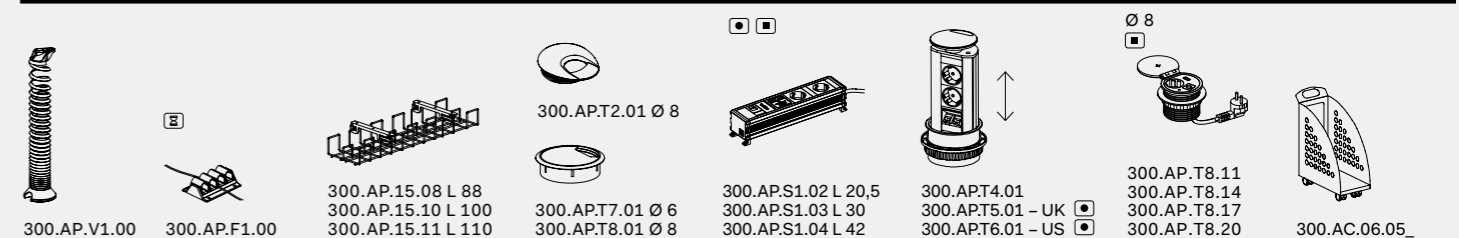

Note:

- 1 Le dimensioni sono espresse in cm - consultare il listino prezzi per le caratteristiche tecniche, i codici degli articoli e delle finiture/Dimensions are stated in cm - for technical characteristics, article code numbers and finishing see price list;
- 2 Per la scelta dei contenitori e degli accessori vari, consultare il relativo listino o catalogo./To choose storage units and accessories, please check correspondent price list or catalogue;
- Prodotti non in pronta consegna. Per la disponibilità contattare l'ufficio commerciale./Items not in prompt delivery. Please contact the commercial department to check availability;
- ▣ Con serratura/With lock.
- Articoli prodotti solo su richiesta./Items produced only on demand;
- V Vetro/Glass.
- A Morsetti o supporti in ABS /ABS clamps
- Z Morsetti o supporti in ZAMA / Zamak clamps
- E Fino ad esaurimento/Until exhaustion;

Cod.

Pag.

DV401 E-Media

282

Modules System

DV401 E-Media

Design:
Antonio Morello

IT Il modulo d'arredo multimediale destinato alla videocomunicazione, è composto da una struttura autoportante predisposta per l'integrazione - su richiesta - di dispositivi multimediali. Destinato alle sale conferenza, alle aree meeting e al lavoro di gruppo; nasce per soddisfare l'esigenza di comunicare e di far interagire più persone contemporaneamente, anche in sedi diverse.

EN The multimedia furniture module dedicated to videoconference, is composed of a freestanding structure prepared to receive optional multimedia devices. Designed for conference rooms, meeting areas and team-work, it has been conceived to satisfy the communication demand, allowing for simultaneous interactivity of several people, even from different locations.





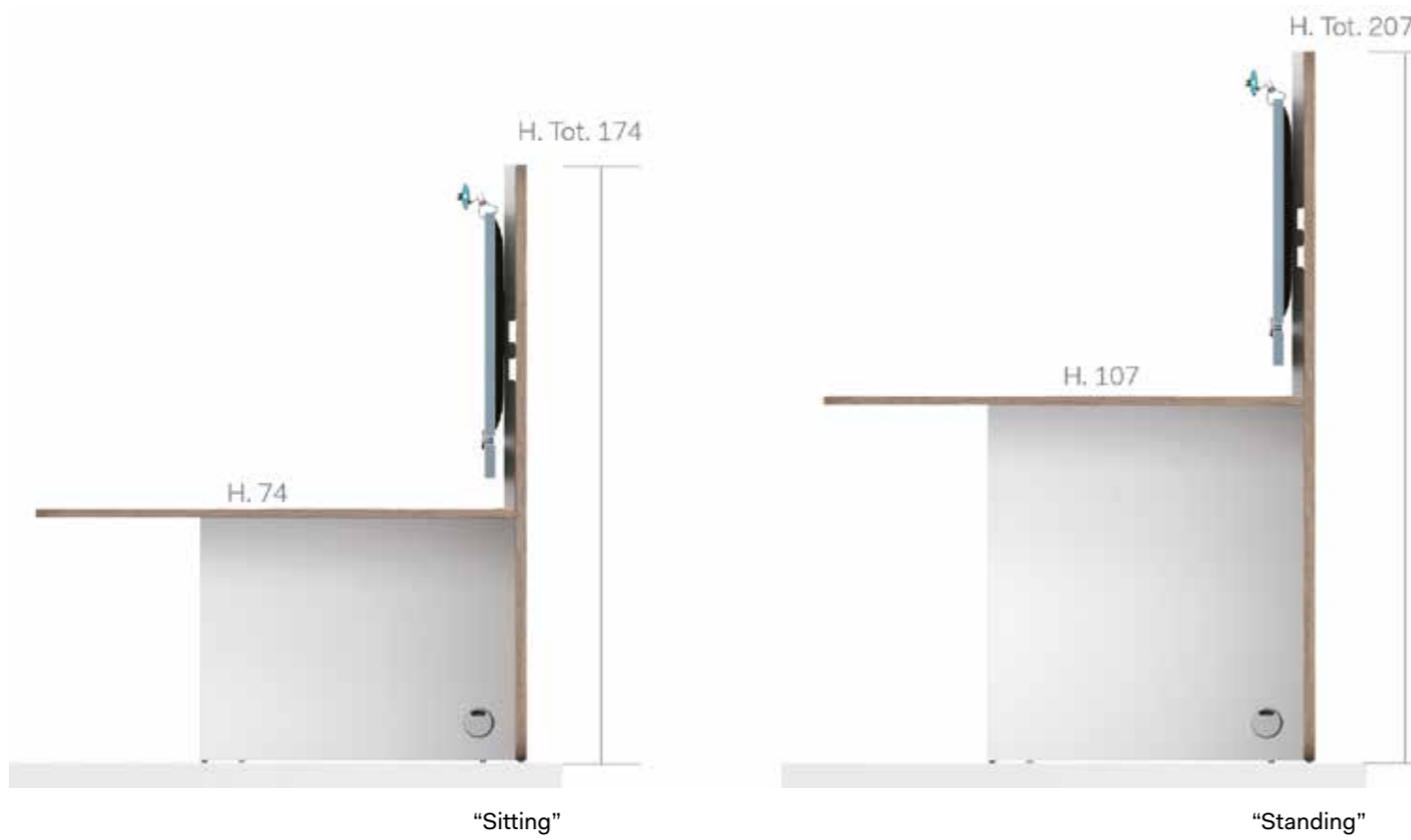





Sistema moduli/Modules system

Piani di lavoro, schiene e basamenti sottopiano sp. 2.5 cm in melaminico/Worktops, backs and undertop pedestal 2.5 cm thick in melamine



E-Media – Dispositivo multimediale/Multi-Media – Device

Canalizzazione/Wire-management

P 160 x H 174

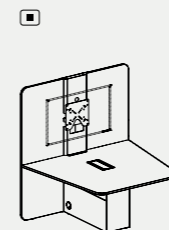

401.SM.01.14_L 142,5
401.SM.01.20_L 202,5

P 160 x H 207

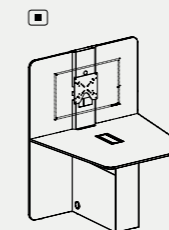

401.SM.02.14_L 142,5
401.SM.02.20_L 202,5

P 61,5 x H 29,3

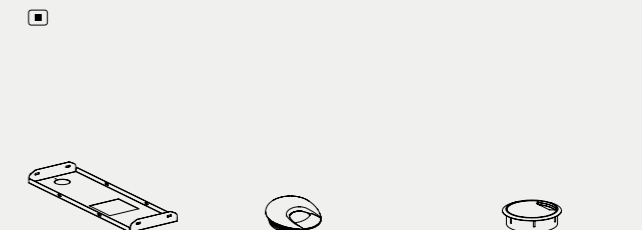

401.VA.01.09_L 89,5
401.VA.02.14_L 149,5
Vassoio aggiuntivo (Optional)
/Additional tray (Optional)

300.AP.T2.01 Ø 8

300.AP.T7.01 Ø 6
300.AP.T8.01 Ø 8

Canalizzazione – Elettrificazione – Accessori/Wire-management – Electrification – Accessories

✱

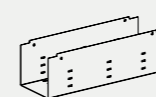

300.AC.25.04 L 43,5
Marsupio/Basket

✱ ■

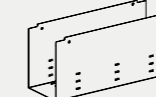

300.AC.56.04 L 43,5
Marsupio optional con altezza
maggiorata/Optional basket
with increased height

■ ■ ■

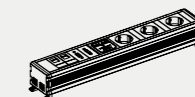

300.AP.S1.04 L 42
Per Marsupio/For Basket:
300.AC.25.03

○ 8

■

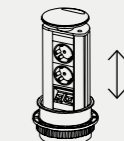

300.AP.T4.01
300.AP.T5.01 – UK ■
300.AP.T6.01 – US ■

○ 8

■

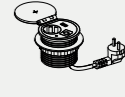

300.AP.T8.11
300.AP.T8.14
300.AP.T8.17
300.AP.T8.20

Note

Per altri accessori, consultare il relativo listino prezzi/For other accessories, see the relative price list.

■ Fino ad esaurimento. / Until exhaustion.

Note:

① Su richiesta Hardware e software. Possibilità di montare il monitor fornito dal cliente/Hardware and software on demand. Possibility to mount the monitor provided by the customer;

② Per la scelta degli accessori vari, consultare il relativo listino o catalogo/To choose accessories, please check correspondent price list or catalogue;

③ Le dimensioni sono espresse in cm – consultare il listino prezzi per le caratteristiche tecniche, i codici degli articoli e delle finiture/Dimensions are stated in cm – for technical characteristics, article code numbers and finishing see price list.

■ Tutti gli articoli della serie DV401 - E-MEDIA non sono in pronta consegna. Per la disponibilità contattare l'ufficio commerciale/All the items of the DV401 - E-MEDIA series are not in prompt delivery. Please contact the commercial department to check availability

■ Articoli prodotti solo su richiesta/Items produced only on demand

■ Fino ad esaurimento/Until exhaustion;

✱ Per Top access./For Top access:
300.AC.20.04

DVO S.R.L. con unico socio
Via XX Settembre, 272
Casella Postale n. 65
U.P. Roveredo in Piano
33080 Roveredo in Piano (PN)
Italy

Tel. +39 0434 386 111
Fax +39 0434 386 112
www.dvo.it
info@dvo.it

Art Director
Enzo Berti

Photo
Tobia Berti
Max Zambelli (DV806)

Rendering
Lone Studio

Stylist
Mara Zambon

Issue 01
April 2021

Foto e testi copyright DVO non riproducibili. La venditrice si riserva la facoltà di apportare al prodotto eventuali modifiche tecniche, dimensionali ed estetiche in qualsiasi momento senza preavviso.

Pictures and text are DVO copyright, duplicate forbidden. The selling Company reserves the right to introduce changes to products regarding sizes and aesthetical or technical aspects at any timewithout notice.



DVO S.R.L. - AZIENDA CERTIFICATA / CERTIFIED COMPANY



Richiedi i prodotti certificati FSC® / Request for FSC® certified products

Il marchio della gestione forestale responsabile

dvo_

DVO S.R.L. con unico socio
Via XX Settembre, 272
Casella Postale n. 65
U.P. Roveredo in Piano
33080 Roveredo in Piano (PN)
Italy

Tel. +39 0434 386 111
Fax +39 0434 386 112
www.dvo.it
info@dvo.it