DV900 Executives

dvo_

dvo_

DV900 Executives

Cod.	Pag.
DV913 Vigo	004
DV911 Noto	036
DV909 Tokio	066
DV905 Rym	072
DV908 Rodi	094
DV903 Tay	102
DV901 Vertigo	124
DV902 Planeta	156
DV910 Oxford	180

Executives

DV913 Vigo

Design:
Baldanzi & Novelli

Comp. N°1

IT DV913 Vigo è un sistema d'arredo direzionale concepito per conferire decisa e peculiare personalità allo spazio ufficio, un habitat professionale all'insegna della tecnologia e del comfort, nonché flessibile e aperto agli spazi condivisi. Poliedrico, sofisticato e dinamico il tavolo è un'opera d'architettura in scala ridotta, minuzioso elemento di design in cui gli importantissimi spessori caratterizzano i fianchi e i robusti piani di lavoro.

EN DV913 Vigo is an executive collection designed to give a strong and distinctive personality to the office space, a professional habitat characterized by technology and comfort, flexible and open to common areas. Multifaceted, sophisticated and dynamic, the table is a work of architecture on a reduced scale, a meticulous design element in which the important thickness characterizes the sides and the robust worktops.









DV913 Vigo

Design:
Baldanzi & Novelli

Comp. N°2





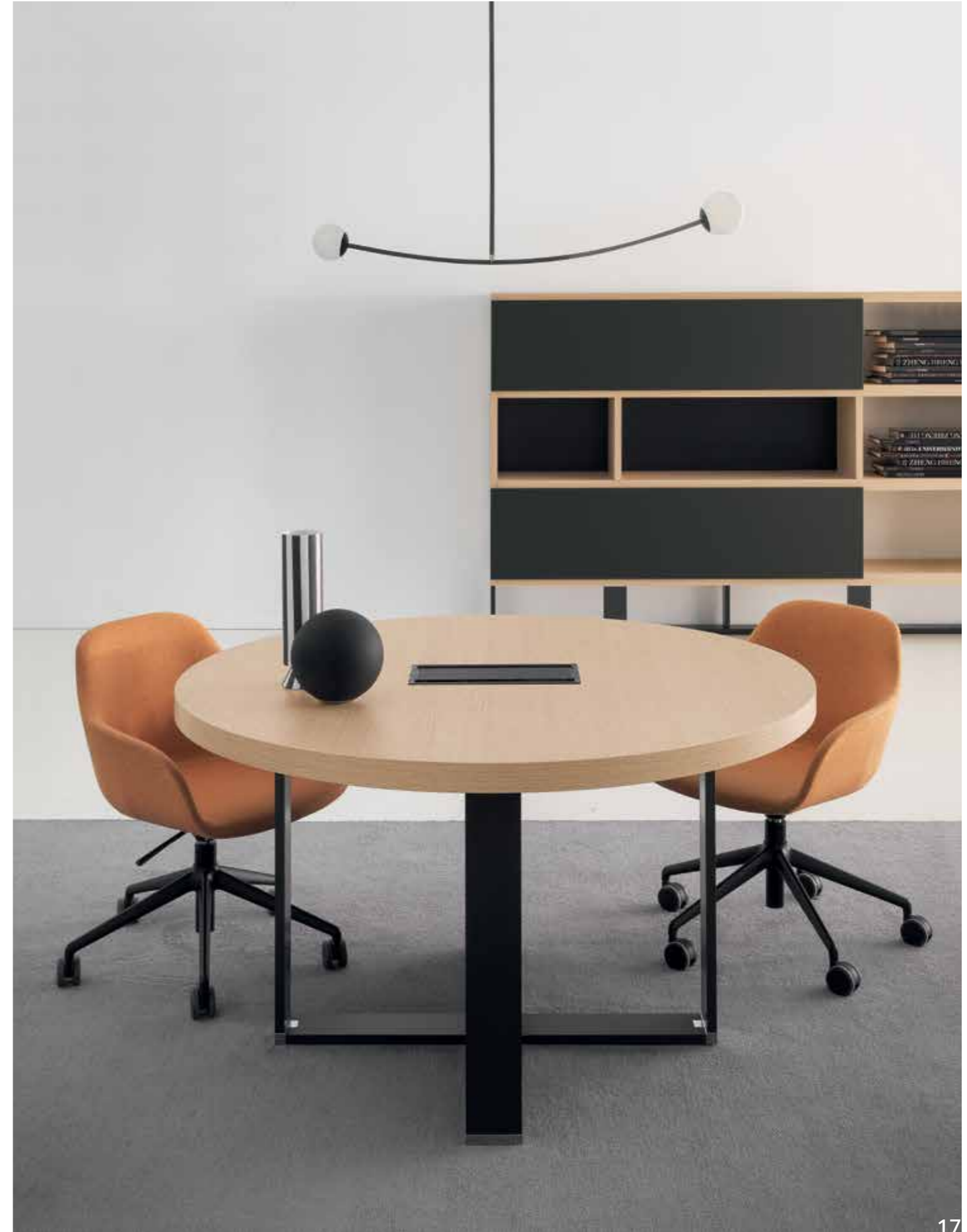



DV913 Vigo

Design:
Baldanzi & Novelli

Comp. N°3





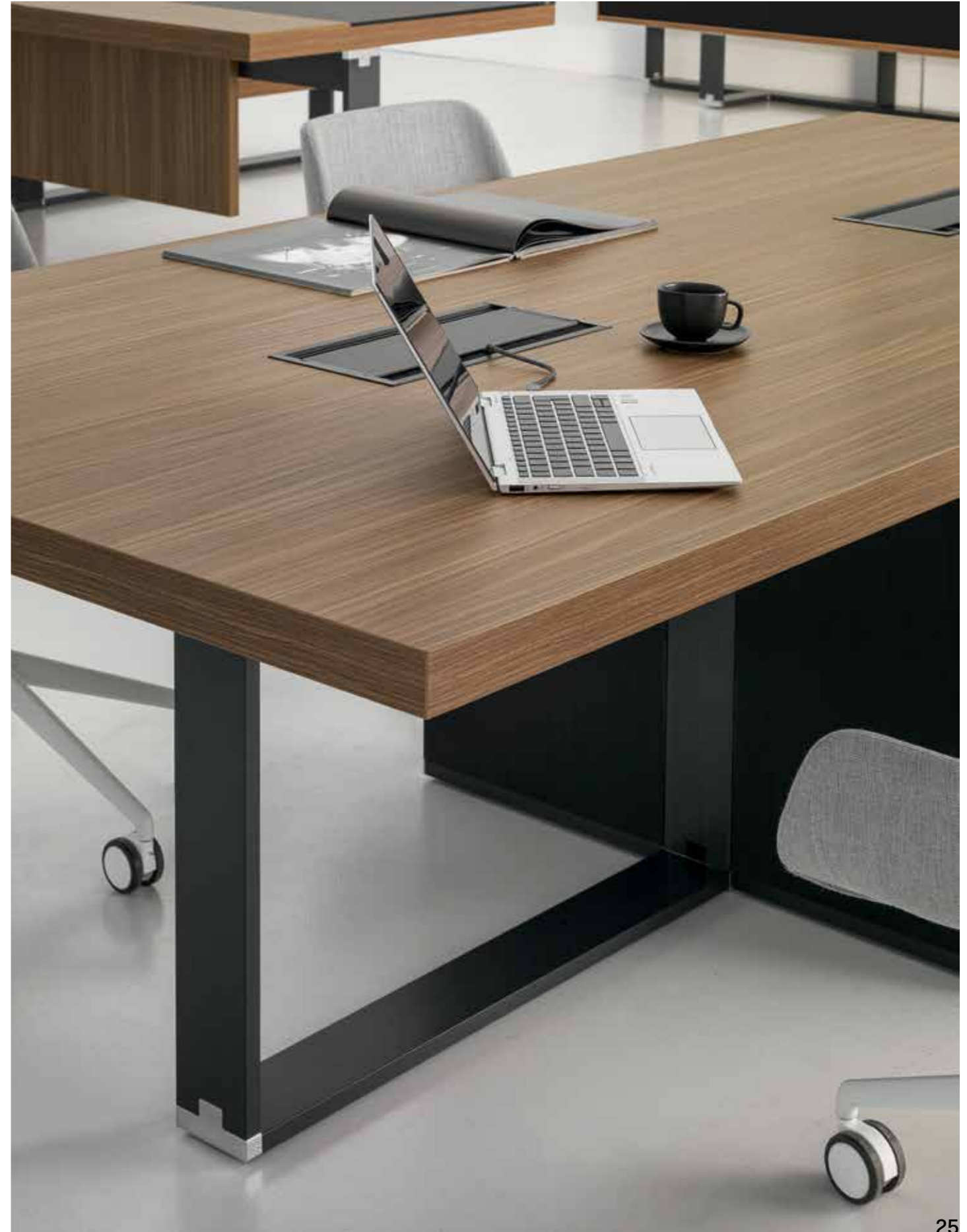

DV913 Vigo

Design:
Baldanzi & Novelli

Comp. N°4

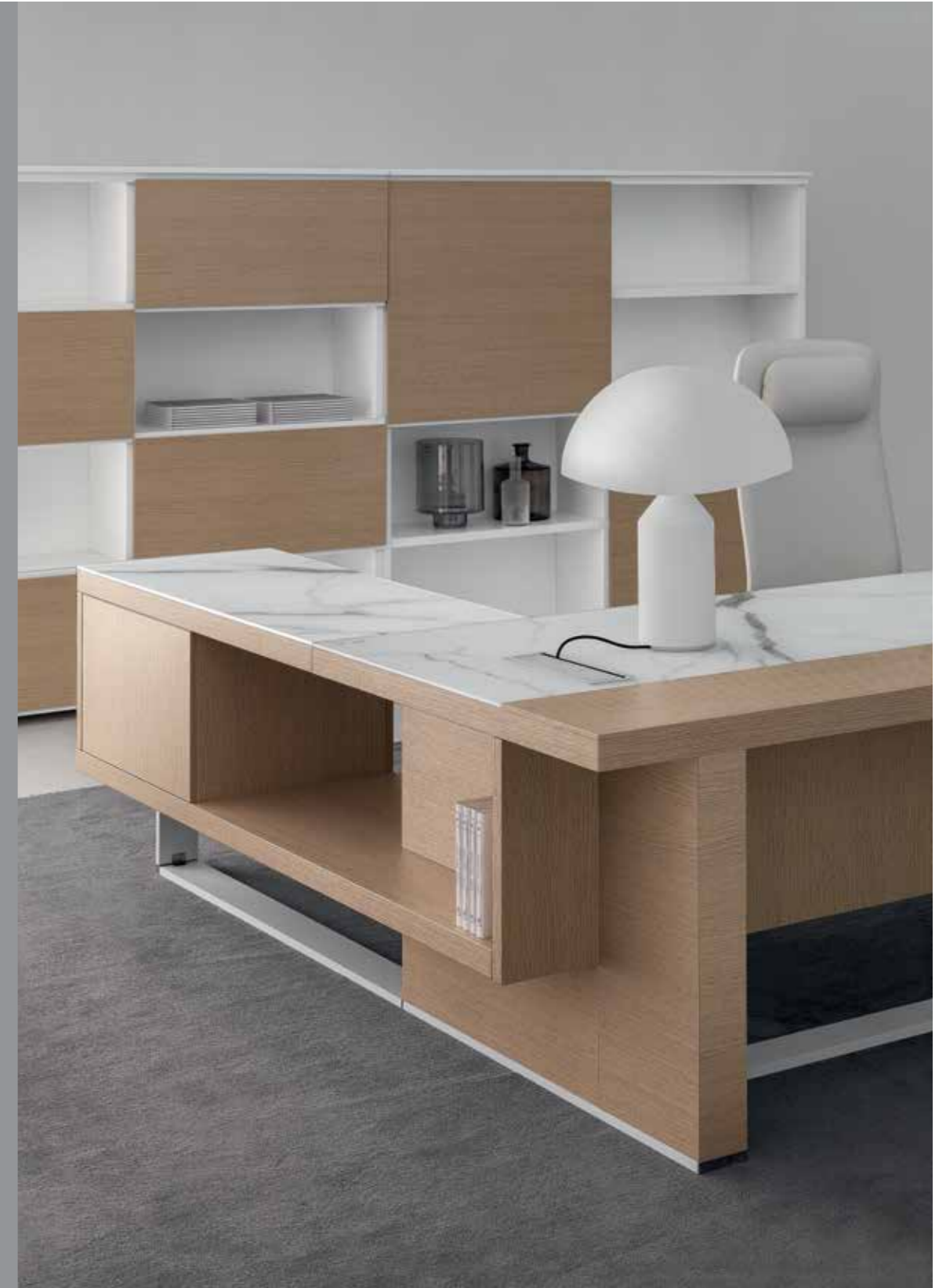







Tavoli/Tables

Piani di lavoro sp. 5 cm, in melaminico/Worktops 5 cm thick, in melamine

NM RC

Noce "Maroncelli"/
"Maroncelli" walnut Rovere chiaro/
Light oak

Piani superiori in melaminico sp. 1 cm, piani composti lato visitatore /
Melamine upper worktops 1 cm thick, compound worktops customer side

NM RC

Noce "Maroncelli"/
"Maroncelli" walnut Rovere chiaro/
Light oak

Piani superiori in vetro serigrafato sp. 1 cm, piani composti lato operatore /
Glass upper worktops 1 cm thick, compound worktops worker side

VSB VSN

Bianco/
White Nero/
Black

Gambe in folding sp. 10 cm/Legs in folding 10 cm thick

Modesty panel sp. 3 cm/Modesty panel 3 cm thick

NM RC NO

Noce "Maroncelli"/
"Maroncelli" walnut Rovere chiaro/
Light oak Nero opaco/
Matt black

NM RC

Noce "Maroncelli"/
"Maroncelli" walnut Rovere chiaro/
Light oak

Cassettiera sp. 1.8 cm per allungo a giorno/Drawer 1.8 cm thick for open extension table

NM RC

Noce "Maroncelli"/
"Maroncelli" walnut Rovere chiaro/
Light oak

Libreria/Bookshelf

Scocca libreria sp. 3 o 5 cm/Bookshelf body 3 or 5 cm thick

Ante a ribalta e schiena libreria sp. 1.8 cm/Bookshelf flap doors and back panel 1.8 cm thick

NM RC

Noce "Maroncelli"/
"Maroncelli" walnut Rovere chiaro/
Light oak

NM RC NO

Noce "Maroncelli"/
"Maroncelli" walnut Rovere chiaro/
Light oak Nero opaco/
Matt black

Strutture metalliche/Metal structures

W H A

Bianco/
White Alluminio/
Aluminium Antracite/
Anthracite

Note

Prodotti non in pronta consegna. Per la disponibilità contattare l'ufficio commerciale/Items not in prompt delivery. Please contact the commercial department to check availability.

Tavoli H. 75 cm con piani di lavoro interi in melaminico sp. 5 / Desk tables H.75 cm with whole worktops in melamine 5 cm thick

<p>P 130 x H 75 <small>PI</small></p> <p>913.TS.61.26_ L 265 Dx/R - Sx/L 913.TS.61.28_ L 285 Dx/R - Sx/L Tavoli scrivania con penisola / Desk tables with peninsula</p>	<p>P 220 x H 75 <small>PI</small></p> <p>913.TM.36.20_ L 200 Dx/R - Sx/L 913.TM.36.22_ L 220 Dx/R - Sx/L Tavoli con allungo a giorno / Tables with open extension</p>	<p>P 220 x H 75 <small>PI</small></p> <p>913.TM.46.23_ L 230 Dx/R - Sx/L 913.TM.46.25_ L 250 Dx/R - Sx/L Tavoli con allungo laterale / Tables with lateral extension</p>
---	---	--

Tavoli H. 76 cm con piani di lavoro sp. 6, composti da piani in melaminico sp. 5 più piani in melaminico o vetro sp. 1 / Desk tables H.76 with 6 cm thick worktops, composed of 5 cm th. melamine worktop plus 1 cm th. melamine or glass top

<p>P 130 - H 76 <small>CM</small></p> <p>913.TS.62.26_ L 265 Dx/R - Sx/L 913.TS.62.28_ L 285 Dx/R - Sx/L Tavoli scrivania con penisola / Desk tables with peninsula</p>	<p>P 220 x H 76 <small>CM</small></p> <p>913.TM.37.20_ L 200 Dx/R - Sx/L 913.TM.37.22_ L 220 Dx/R - Sx/L Tavoli con allungo a giorno / Tables with open extension</p>	<p>P 220 x H 76 <small>CM</small></p> <p>913.TM.47.23_ L 230 Dx/R - Sx/L 913.TM.47.25_ L 250 Dx/R - Sx/L Tavoli con allungo laterale / Tables with lateral extension</p>
---	---	--

Penisola H. 75 cm con piano in melaminico sp. 5 / Peninsula H.75 cm with melamine top 5 cm thick

Ž 130 x H 75
PI

913.PE.01.13_ Dx/R - Sx/L

Penisola H. 76 cm con piano sp. 6 cm, composto da piani in melaminico sp. 5 + 1 cm / Peninsula H.76 cm with 6 cm thick top, composed of 5 cm + 1 cm th. melamine tops

Ž 130 x H 76
CM

913.PE.02.13_ Dx/R - Sx/L

Tavoli riunione H. 75 cm con piani di lavoro interi in melaminico sp. 5 cm con bordi perimetrali in ABS / Meeting tables H.75 cm with whole worktops in melamine 5 cm thick with perimetrical edges in ABS

<p>P 120 - H 75</p> <p>913.TR.41.24_ L 240</p>	<p>Ø 140 - H 75</p> <p>913.TR.11.14_</p>
--	--

Libreria con ante a ribalta / Bookshelf with flap doors

P 45 - H 158

913.CL.RL.20_ L 215

Note:

- | | | |
|---|---|--|
| <p>1 Le finiture in vetro serigrafato non sono in pronta consegna. Per la disponibilità contattare l'ufficio commerciale / Silkscreen glass finishes are not in prompt delivery. Please contact the commercial department to check availability;</p> | <p>3 Per la scelta dei contenitori e degli accessori vari, consultare il relativo listino o catalogo/To choose storage units and accessories, please check correspondent price list or catalogue;</p> | <p>⊗ Ai tavoli con allungo a giorno è possibile integrare la cassettera 913.MC.02.06_ / It is possible to integrate 913.MC.02.06_ pedestals in the tables with open extension.</p> |
| <p>2 Le dimensioni sono espresse in cm - consultare il listino prezzi per le caratteristiche tecniche, i codici degli articoli e delle finiture/Dimensions are stated in cm - for technical characteristics, article code numbers and finishing see price list;</p> | <p>■ Prodotti non in pronta consegna. Per la disponibilità contattare l'ufficio commerciale/Items not in prompt delivery. Please contact the commercial department to check availability;</p> | <p>PI Piano intero/ Full worktop.
CM Piano composto/Compound worktop.</p> |

Cassettera con 1 cassetto per tavolo con allungo a giorno / Drawer with one drawer for tables with open lateral extension ⊗

L 60 P 50 x H 36,5
⊗

913.MC.02.06_

Accessori per cassettera cod. 913.MC.02.06 / Accessories for drawer cod. 913.MC.02.06 ⊗

<p>L 56 P 41 x H 11 <small>⊗</small></p> <p>913.CS.01.05 Cassetto Optional interno / Optional internal drawer</p>	<p>L 55 P 40 x H 8</p> <p>913.CA.S6.08 Reggicartella per cassetto / Frame for folders for drawers</p>	<p>503.CS.P1.00 L 33 503.CS.P2.00 L 39</p>
---	---	--

Note: Per l'integrazione degli accessori con la cassettera consultare il manuale tecnico / For integration of accessories with the drawers please check technical manual

Cassettiere su ruote/Pedestals on castors

<p>L 42 P 57 x H 55,5 <small>⊗</small></p> <p>550.CS.10.04_ Melaminico / Melamine</p>	<p>550.CS.20.04_ Melaminico / Melamine</p>	<p>L 32,2 P 54,2 x H 55,6 <small>⊗</small></p> <p>550.CS.1M.03_ Metalliche / Metallic</p>	<p>550.CS.2M.03_ Metalliche / Metallic</p>	<p>L 42,2 P 54,2 x H 55,6 <small>⊗</small></p> <p>550.CS.1M.04_ Metalliche - Vaschetta porta cancelleria inclusa /Metallic - Stationery tray included</p>	<p>550.CS.2M.04_ Metalliche - Vaschetta porta cancelleria inclusa /Metallic - Stationery tray included</p>
---	--	---	--	---	--

Note: La finitura impiallacciato non è in pronta consegna. Per la disponibilità contattare l'ufficio commerciale. Per portacancelleria cassetti, vedi capitolo DV300-Accessori / Veneered finishes is not in prompt delivery. Please contact the commercial department to check availability. For stationary tray, see chapter DV300-Accessories.

Accessori per Elettrificazione - Vari/Accessories for Electrification - Various

■ □ L 90 P 60 x H 2

300.AP.S1.02 L 20,5
300.AP.S1.03 L 30
300.AP.S1.04 L 42

300.AS.01.09

Note:

- | | | |
|---|---|--|
| <p>1 Le finiture in vetro serigrafato non sono in pronta consegna. Per la disponibilità contattare l'ufficio commerciale / Silkscreen glass finishes are not in prompt delivery. Please contact the commercial department to check availability;</p> | <p>3 Per la scelta dei contenitori e degli accessori vari, consultare il relativo listino o catalogo/To choose storage units and accessories, please check correspondent price list or catalogue;</p> | <p>■ Articoli prodotti solo su richiesta/Items produced only on demand;</p> |
| <p>2 Le dimensioni sono espresse in cm - consultare il listino prezzi per le caratteristiche tecniche, i codici degli articoli e delle finiture/Dimensions are stated in cm - for technical characteristics, article code numbers and finishing see price list;</p> | <p>■ Prodotti non in pronta consegna. Per la disponibilità contattare l'ufficio commerciale/Items not in prompt delivery. Please contact the commercial department to check availability;</p> | <p>⊗ Ai tavoli con allungo a giorno è possibile integrare la cassettera 913.MC.02.06_ / It is possible to integrate 913.MC.02.06_ pedestals in the tables with open extension.</p> |

DV911 Noto

Design:
Enzo Berti

Comp. N°1

IT DV911 Noto trae ispirazione dal classico “tavolo da lavoro” su cavalletto, ora ripensato in chiave contemporanea. Materiali tradizionali inseriti in un contesto attuale, in linea con un nuovo modo di vivere l'ufficio molto più vicino alla dimensione domestica, sicuramente più calorosa e accogliente. La collezione è anche integrabile al sistema DV504-Milo, grazie ad un'apposita variante del tavolo che si aggancia alla barra.

EN DV911 Noto is inspired by the classic “work table” on trestle base, now reconfigured in a contemporary way. Traditional materials placed in a present context, in line with a new way of living the office much closer to the domestic dimension, certainly warmer and more welcoming. The collection can also be integrated with the DV504-Milo system, thanks to a special element of the table that hooks to the bar.

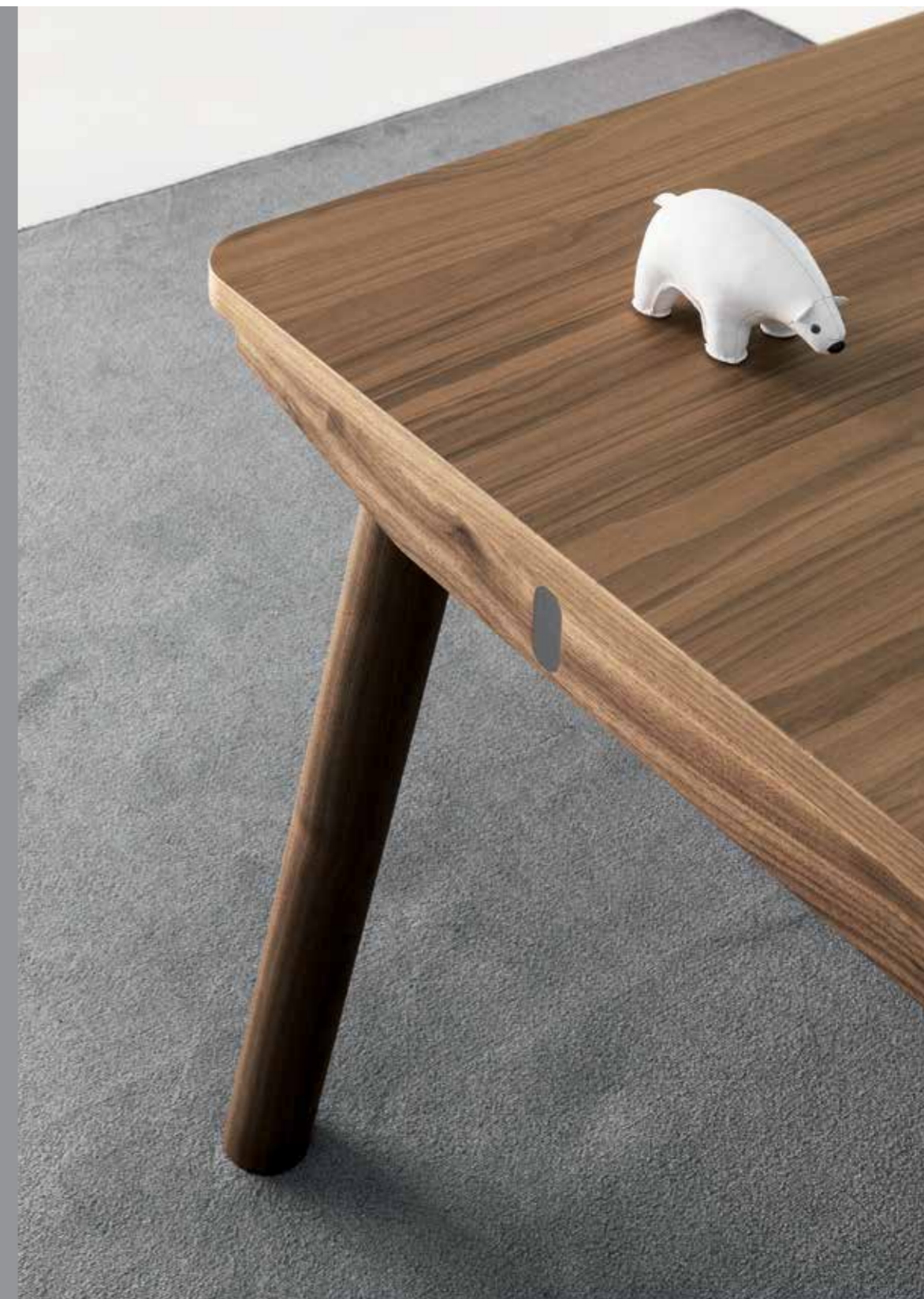





DV911 Noto

Design:
Enzo Berti

Comp. N°2

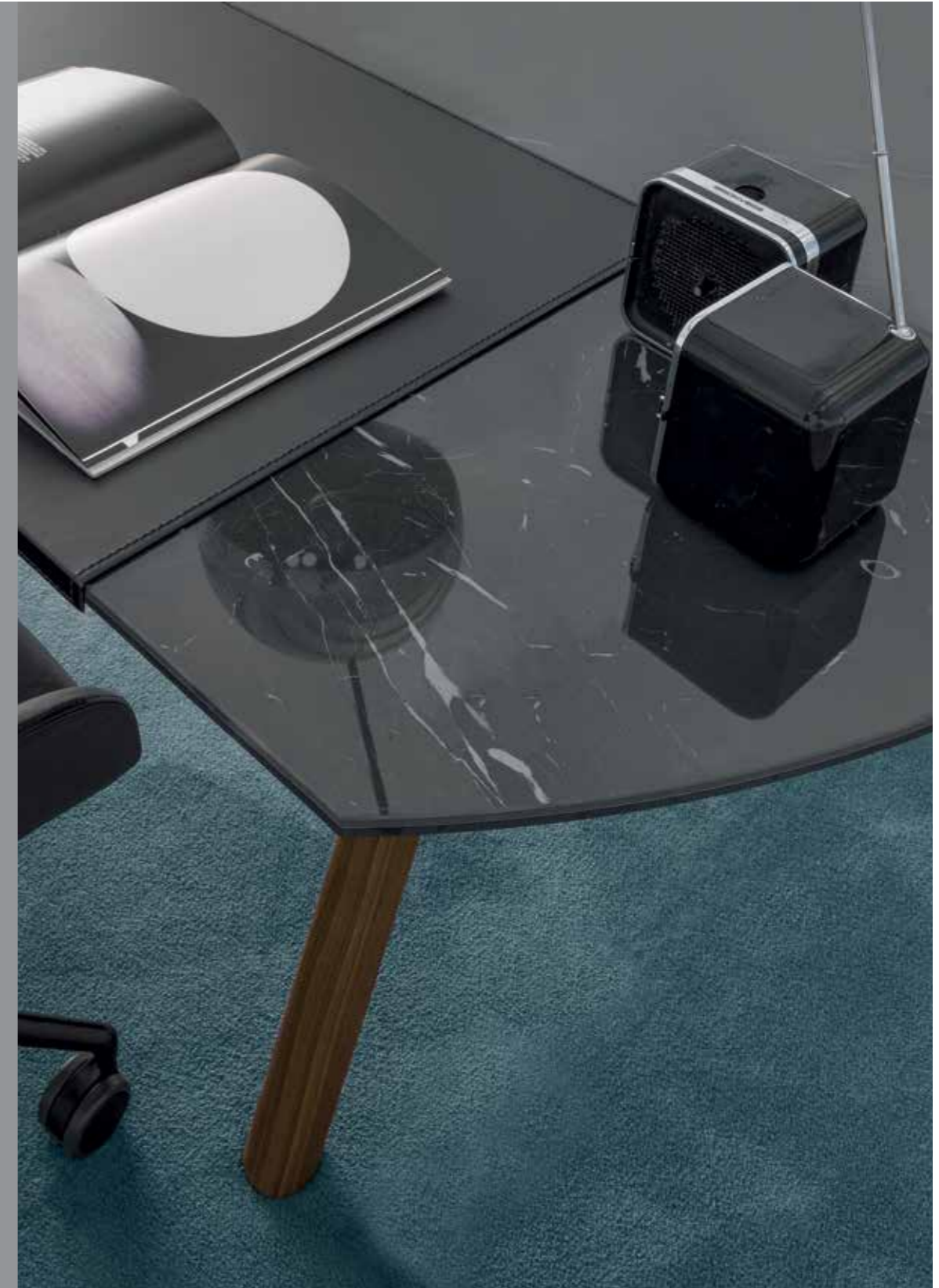







DV911 Noto

Design:
Enzo Berti

Comp. N°3

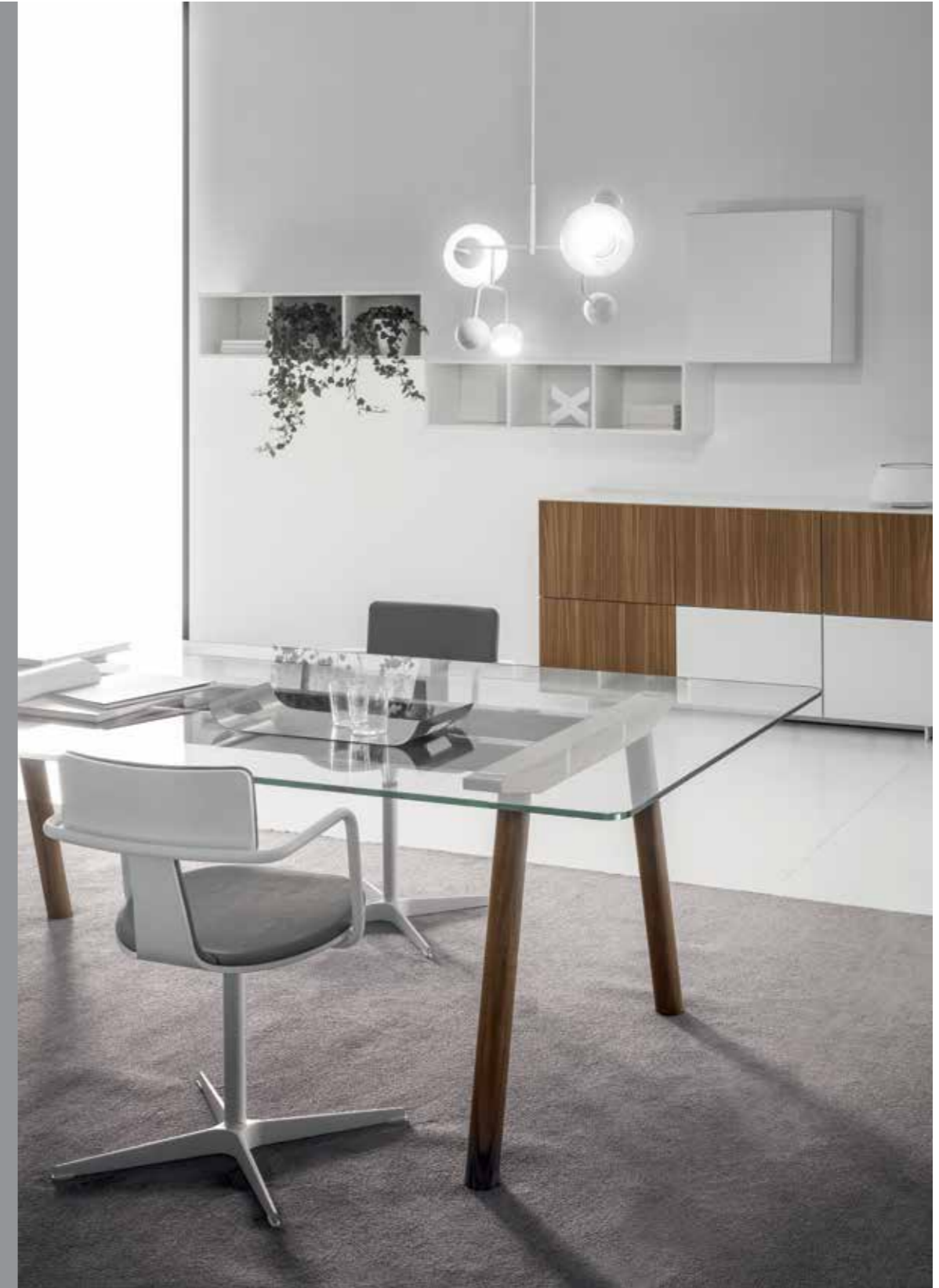



DV911 Noto

Design:
Enzo Berti

Comp. N°4









Tavoli / Tables

Piani di lavoro in vetro sp. 1.2 cm, con bordi perimetrali lavorati a filo lucido / Glass worktop 1.2 cm thick, with outer polished edges

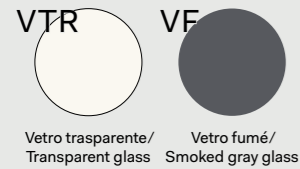

Piano di lavoro in vetro temprato trasparente sp. 0.8 cm, accoppiato con piano in gres porcellanato sp. 0.6 cm / Worktop in 0.8 cm thick transparent tempered glass, coupled with a 0.6 cm thick porcelain stoneware worktop



Piani di lavoro sp. 2.5 cm, in impiallacciato / Veneered worktop 2.5 cm thick

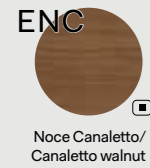

Piani di lavoro sp. 2.7 cm, in cuoio con cuciture / Worktop 2.7 cm thick, in leather with stitches



Gambe in legno / Wooden legs



Travi in legno per piani in vetro / Wooden legs for glass worktops

Travi metalliche per piani ciechi e canalizzazione / Metallic beams for non-transparent worktops and canalization



Modesty panel / Modesty panel

Modesty panel in melaminico sp. 2.5 cm / Melamine modesty panel 2.5 cm thick

Modesty panel sp. 2.7 cm, in cuoio con cuciture / Modesty panel 2.7 cm thick, in leather with stitches

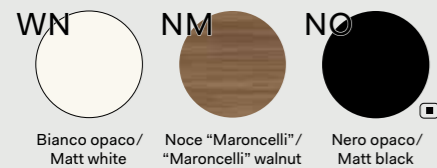

Modesty panel sp. 2.5 cm, in impiallacciato / Veneered modesty panel 2.5 cm thick

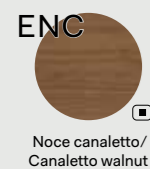

Note

■ Prodotti non in pronta consegna. Per la disponibilità contattare l'ufficio commerciale / Items not in prompt delivery. Please contact the commercial department to check availability.

Tavoli scrivania con piani in vetro / Desk tables with glass work-top



Tavoli scrivania con piani in gres porcellanato / Desk tables with porcelain stoneware work-top



Tavoli con piani impiallacciati / Desk tables with veneered work-top



Tavoli con piani in cuoio / Desk tables with leather work-top

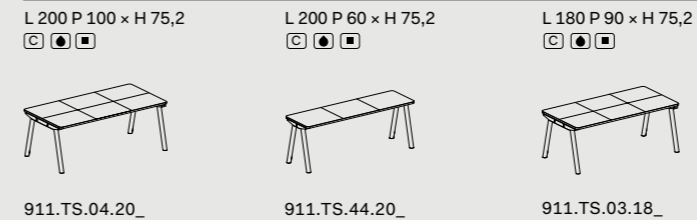

Tavoli scrivania / riunione / Meeting-desk tables

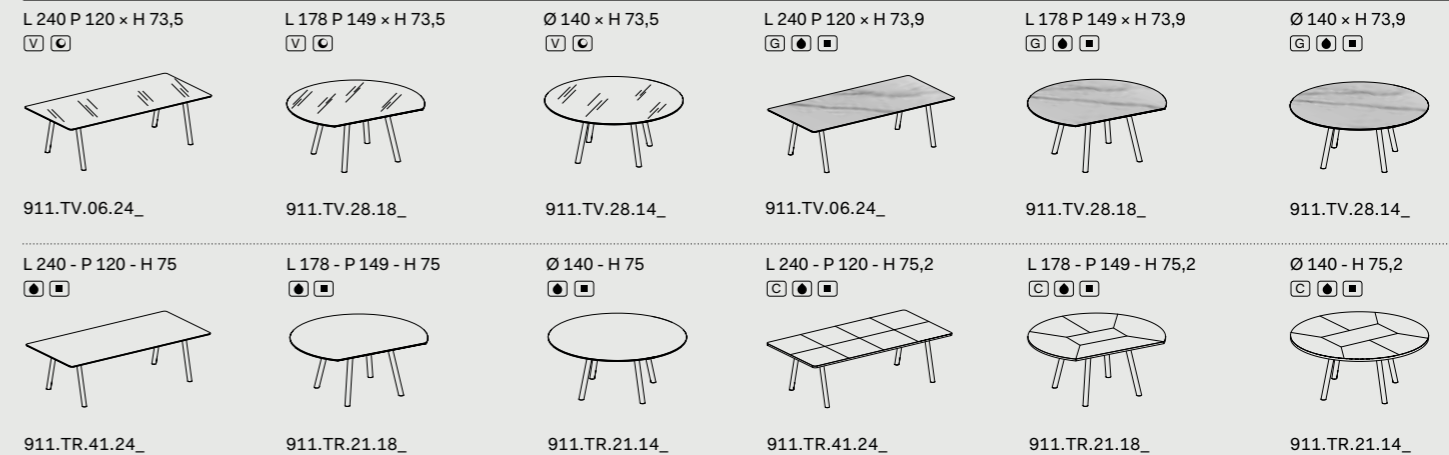

Note:

1 Le finiture impiallacciato, gres e cuoio non sono in pronta consegna. Per la disponibilità contattare l'ufficio commerciale / Veneered, porcelain stoneware and leather finishes are not in prompt delivery. Please contact the commercial department to check availability;

2 Per la scelta dei contenitori e degli accessori vari, consultare il relativo listino o catalogo / To choose storage units and accessories, please check correspondent price list or catalogue;

3 Le dimensioni sono espresse in cm - consultare il listino prezzi per le caratteristiche tecniche, i codici degli articoli e delle finiture / Dimensions are stated in cm - for technical characteristics, article code numbers and finishing see price list;

■ Con gambe in legno e travi in metallo / Wood legs and metal beams
■ Con gambe in legno e travi in metallo / Wood legs and metal beams
■ Con gambe in legno e travi in metallo / Wood legs and metal beams
■ Con gambe in legno e travi in metallo / Wood legs and metal beams
■ Con gambe in legno e travi in metallo / Wood legs and metal beams
■ Con gambe in legno e travi in metallo / Wood legs and metal beams

■ Prodotti non in pronta consegna. Per la disponibilità contattare l'ufficio commerciale / Items not in prompt delivery. Please contact the commercial department to check availability;

■ Gres / Gres
■ Cuoio / Leather

Tavoli scrivania per integrazione su barra (DV504)/Desk tables for integration on bar (DV504)

L 200 P 100 x H 73,5 V C	L 200 P 60 x H 73,5 V C	L 180 P 90 x H 73,5 V C	L 200 P 100 x H 73,9 G C	L 200 P 60 x H 73,9 G C	L 180 P 90 x H 73,9 G C
911.TV.32.20_	911.TV.30.20_	911.TV.31.18_	911.TV.32.20_	911.TV.30.20_	911.TV.31.18_
L 200 P 100 x H 75 C	L 200 P 60 x H 75 C	L 180 P 90 x H 75 C	L 200 P 100 x H 75,2 C	L 200 P 60 x H 75,2 C	L 180 P 90 x H 75,2 C
911.TI.22.20_	911.TI.20.20_	911.TI.21.18_	911.TI.22.20_	911.TI.20.20_	911.TI.21.18_

Tavoli per integrazione su moduli base (DV504)/Desks for integration on modules (DV504 series)

L 200 P 100 x H 73,5 V C	L 200 P 60 x H 73,5 V C	L 180 P 90 x H 73,5 V C	L 200 P 100 x H 73,9 G C	L 200 P 60 x H 73,9 G C	L 180 P 90 x H 73,9 G C
911.TV.09.20_	911.TV.29.20_	911.TV.11.18_	911.TV.09.20_	911.TV.29.20_	911.TV.11.18_
L 200 P 100 x H 75 C	L 200 P 60 x H 75 C	L 180 P 90 x H 75 C	L 200 P 100 x H 75,2 C	L 200 P 60 x H 75,2 C	L 180 P 90 x H 75,2 C
911.TI.13.20_	911.TI.01.20_	911.TI.15.18_	911.TI.13.20_	911.TI.01.20_	911.TI.15.18_

Cassettiere su ruote/Pedestals on castors

L 42 P 57 x H 55,5 C	L 32,2 P 54,2 x H 55,6 C	L 42,2 P 54,2 x H 55,6 C
550.CS.10.04_ /Melaminico /Melamine	550.CS.20.04_ /Melaminico /Melamine	550.CS.1M.03_ Metalliche /Metallic
550.CS.2M.03_ Metalliche /Metallic	550.CS.1M.04_ Metalliche - Vaschetta porta cancelleria inclusa /Metallic - Stationery tray included	550.CS.2M.04_ Metalliche - Vaschetta porta cancelleria inclusa /Metallic - Stationery tray included

Note: La finitura impiallacciato non è in pronta consegna. Per la disponibilità contattare l'ufficio commerciale. Per portacancelleria cassetti, vedi capitolo DV300-Accessori /Veneered finishes is not in prompt delivery. Please contact the commercial department to check availability. For stationary tray, see chapter DV300-Accessories.

Note:

- 1 Le finiture impiallacciato, gres e cuoio non sono in pronta consegna. Per la disponibilità contattare l'ufficio commerciale /Veneered, porcelain stoneware and leather finishes are not in prompt delivery. Please contact the commercial department to check availability;
- 2 Per la scelta dei contenitori e degli accessori vari, consultare il relativo listino o catalogo /To choose storage units and accessories, please check correspondent price list or catalogue;
- 3 Le dimensioni sono espresse in cm - consultare il listino prezzi per le caratteristiche tecniche, i codici degli articoli e delle finiture /Dimensions are stated in cm - for technical characteristics, article code numbers and finishing see price list;
- 4 Prodotti non in pronta consegna. Per la disponibilità contattare l'ufficio commerciale /Items not in prompt delivery. Please contact the commercial department to check availability;
- 5 Con gambe in legno e travi in legno /Wood legs and beams
- 6 Con gambe in legno e travi in metallo /Wood legs and metal beams
- 7 Gres/Gres
- 8 Gres/Gres
- 9 Vetro/Glass
- 10 Cuoio/Leather
- 11 Con serratura /With lock.

Modesty panel

P 1,8 x H 32

911.MP.03.08_L 76
911.MP.01.18_L 127
911.MP.01.20_L 147

Modesty panel in cuoio/Leather modesty panel

P 2 x H 32

911.MP.03.08_L 76
911.MP.01.18_L 127
911.MP.01.20_L 147

Accessori per canalizzazione - Elettrificazione - Vari /Accessories for wire management - Electrification - Various

300.AC.26.02 L 24,5	300.AC.26.03 L 34,5	300.AC.26.04 L 44,5	300.AP.S1.02 L 20,5	300.AP.S1.03 L 30	300.AP.S1.04 L 42	300.AT.A6.02 L 21	300.AT.A6.03 L 25,5	300.AT.A6.04 L 39	300.AP.T4.01	300.AP.T5.01 - UK	300.AP.T6.01 - US	300.AP.T8.11	300.AP.T8.14	300.AP.T8.17	300.AP.T8.20

300.AC.38.03_H 3	300.AC.67.03 Marsupio per top access 300.AC.36_..._ 300.AC.38_..._ / Basket for top access 300.AC.36_..._ 300.AC.38_..._	300.APV1.00	911.AP.08.06_ Canalina verticale per gamba /Vertical cable channel for leg	300.AP.F1.00

911.AP.01.20_L 146 Per tavoli P. 60 cm /For desks P.60	911.AP.41.20_L 180 Carter canaline singole per piani in vetro/Covering carter for glass worktops	911.AP.02.18_L 126 Per tavoli P. 90-100-120 cm /For desks P. 90-100-120 cm	911.AP.02.20_L 146 Per tavoli P. 90-100-120 cm /For desks P. 90-100-120 cm	911.AP.03.07_L 71 Per tavoli tondi /For round tables	911.AP.45.08 L 84	911.AP.43.18 L 160	911.AP.43.20 L 180 Carter canaline doppie per piani in vetro/Carter for double cable channels for glass worktops	911.AP.42.20_L 182 Carter canaline singole per piani in vetro su barra/Carter for single cable channels for glass worktops on bar	911.AP.44.18 L 162 Carter canaline doppie per piani in vetro su barra/Carter for double cable channels for glass worktops on bar

300.AC.04.01 Braccio porta video mobile su piano /Dynamic arm for video support on deskbase	300.AC.04.02 Doppio braccio porta video mobile su piano /2 dynamic arms for video support on deskbase	300.AC.03.01 Braccio porta video statico su palo /Dynamic arm for video support on deskbase	300.AC.03.02 Doppio braccio porta video statico su palo /2 Static arms for video support on pole	300.AC.02.01 Braccio porta video mobile su piano /Dynamic arm for video support on deskbase	300.AC.02.02 Doppio braccio porta video mobile su piano /2 dynamic arms for video support on deskbase	300.AC.01.01 Braccio porta video statico su palo /Static arm for video support on pole

300.AC.01.02 Doppio braccio porta video statico su palo /2 Static arms for video support on pole	300.AS.01.09_	300.AC.06.05_

Note:

- 1 Le finiture impiallacciato, gres e cuoio non sono in pronta consegna. Per la disponibilità contattare l'ufficio commerciale /Veneered, porcelain stoneware and leather finishes are not in prompt delivery. Please contact the commercial department to check availability;
- 2 Per la scelta dei contenitori e degli accessori vari, consultare il relativo listino o catalogo /To choose storage units and accessories, please check correspondent price list or catalogue;
- 3 Le dimensioni sono espresse in cm - consultare il listino prezzi per le caratteristiche tecniche, i codici degli articoli e delle finiture /Dimensions are stated in cm - for technical characteristics, article code numbers and finishing see price list;
- 4 Prodotti non in pronta consegna. Per la disponibilità contattare l'ufficio commerciale /Items not in prompt delivery. Please contact the commercial department to check availability;
- 5 Articoli prodotti solo su richiesta /Items produced only on demand;
- 6 Fino ad esaurimento /Until exhaustion;
- 7 Cuoio/Leather

DV909 Tokio

Design:
Antonio Morello

Comp. N°1 - 2

IT È una collezione di tavoli direzionali il cui segno stilistico si distingue per la purezza delle linee e dove ogni singolo dettaglio è studiato per esaltare la struttura architettonica di un tavolo dal forte impatto estetico. La struttura presenta gambe in metallo il cui orientamento obliquo è un elemento che oltre a conferire originale leggerezza al tavolo ne favorisce una più comoda fruizione da parte dell'utente.

EN The collection of executive tables is the purity of lines, where every single detail is designed to enhance the architectural structure of a table with a strong aesthetic impact. The structure has metal legs whose oblique orientation is an element that, in addition to giving the table original lightness, favors a more comfortable use by the user.





Tavoli/Tables

Piani di lavoro sp. 3.7 cm, in folding con laminato FENIX /
Folding worktops 3.7 cm thick, in FENIX laminate
(140x140 cm - 380x120 cm / 55 1/8"x55 1/8" - 149 5/8"x47 1/4")

Piani di lavoro sp. 4.2 cm, in listellare placcato laminato con bordi in ABS sp. 0.1 cm
Worktop 4.2 cm thick in laminate with 0.1 cm ABS edge-profiles
(240x120 cm - 300x120 cm - 360x120 cm / 94 7/16"x47 1/4" - 118 1/8"x47 1/4" - 141 3/4" D 47 1/4")



Strutture metalliche/Metal structures

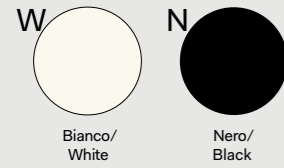

Tavoli riunione/Meeting tables

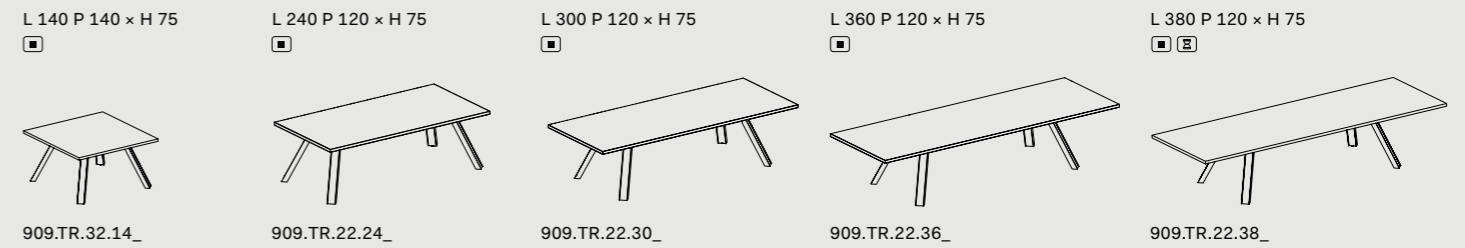

Tavoli riunione con top access /Meeting tables with top access

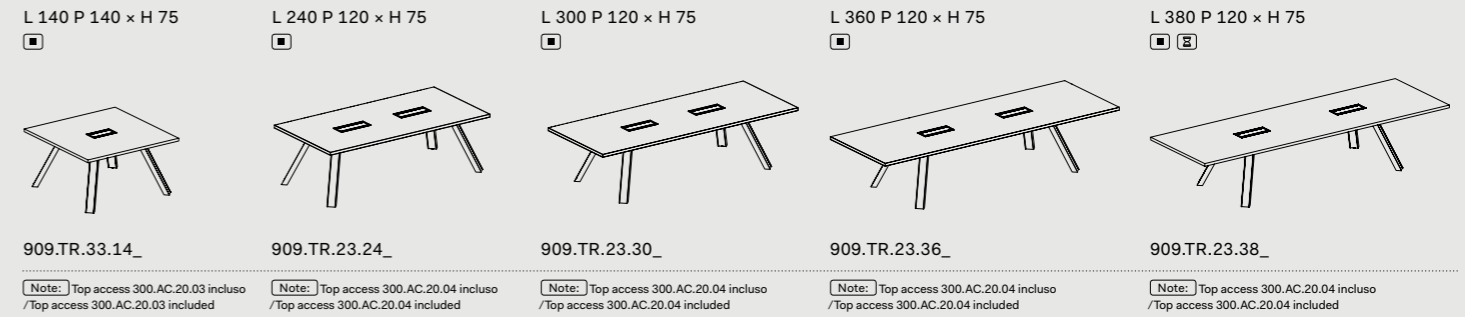

Accessori per canalizzazione - Elettrificazione /Accessories for wire management - Electrification

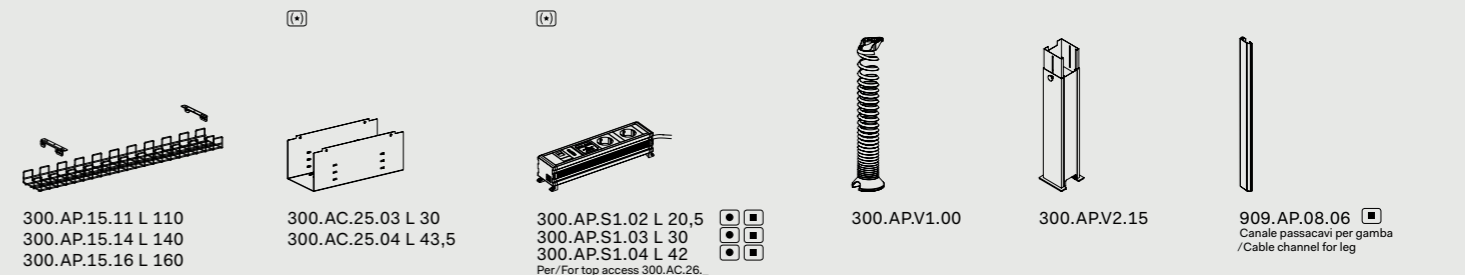

Note

Prodotti non in pronta consegna. Per la disponibilità contattare l'ufficio commerciale./Items not in prompt delivery. Please contact the commercial department to check availability.
 Fino ad esaurimento/Until exhaustion.

Note:

Per la scelta dei contenitori e degli accessori vari, consultare il relativo listino o catalogo./To choose storage units and accessories, please check correspondent price list or catalogue;
 Le dimensioni sono espresse in cm - consultare il listino prezzi per le caratteristiche tecniche, i codici degli articoli e delle finiture./Dimensions are stated in cm - for technical characteristics, article code numbers and finishing see price list;
 Prodotti non in pronta consegna. Per la disponibilità contattare l'ufficio commerciale./Items not in prompt delivery. Please contact the commercial department to check availability;
 Fino ad esaurimento/Until exhaustion;
 Articoli prodotti solo su richiesta./Items produced only on demand.

DV905 Rym

Design:
Antonio Morello

Comp. N°1

IT Stile, funzionalità e design – Prestigiosa collezione direzionale, dove la ricerca progettuale trova massima espressione. Ampie superfici, stile minimal, ricerca del dettaglio esprimono l'anima di questa collezione.

EN Style, functionality and design – Prestigious executive collection, where the design research finds highest expression. Large surfaces, minimalistic style, detail research express the soul of this collection.





DV905 Rym

Design:
Antonio Morello

Comp. N°2

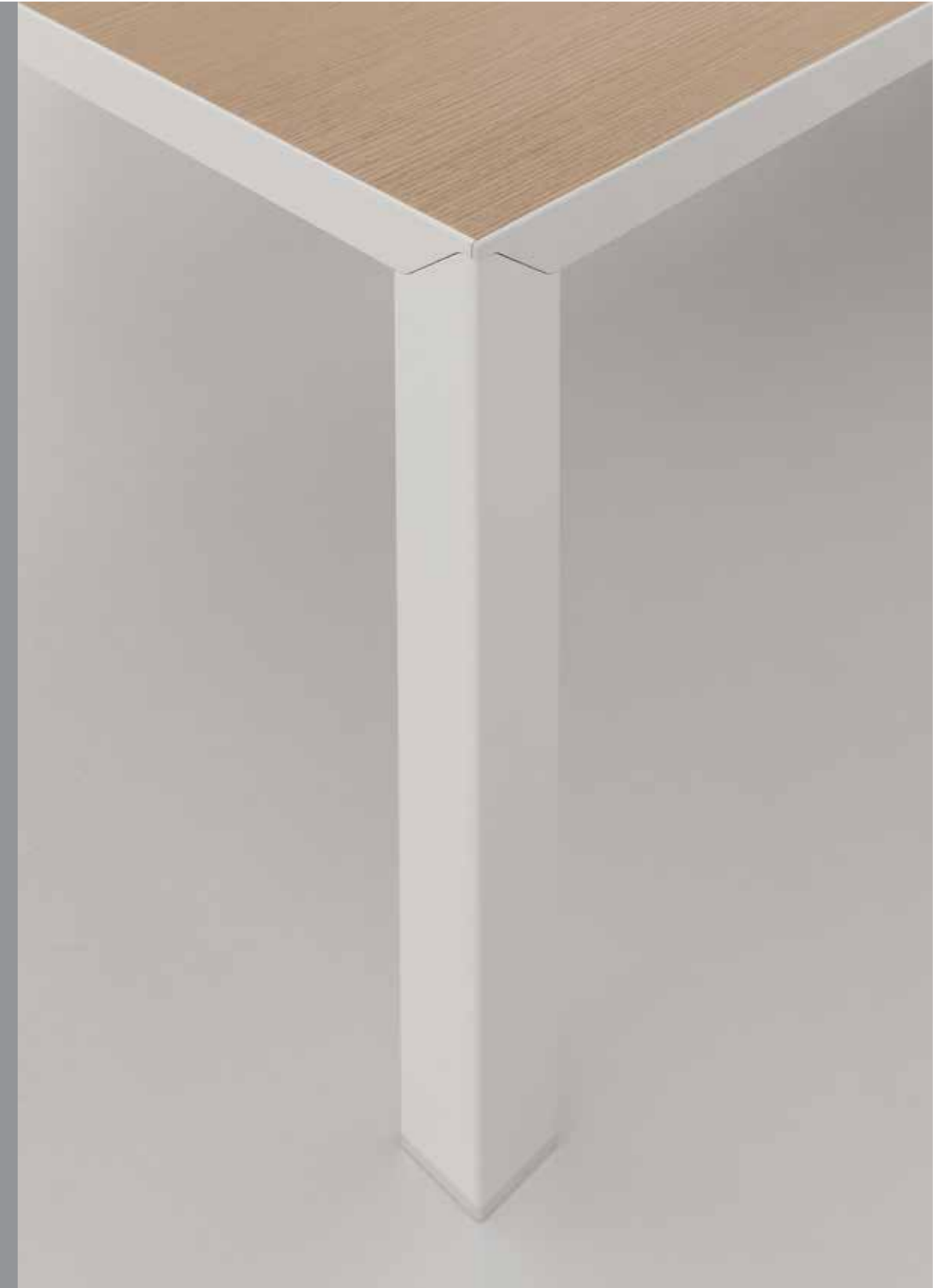





DV905 Rym

Design:
Antonio Morello

Comp. N°3





DV905 Rym

Design:
Antonio Morello

Comp. N°4







Tavoli/Tables

Piani di lavoro sp. 5 cm, in laminatino/Worktops 5 cm thick, in low pressure laminate

Piani di lavoro sp. 5 cm, in laminatino Fenix/Worktops 5 cm thick, in low pressure Fenix laminate

WN RC RM RT

Bianco opaco/
Matt white
 Rovere chiaro/
Light oak
 Rovere Moro/
Dark oak
 Rovere tabacco/
Tobacco oak

NO

Nero opaco/
Matt black

Piani di lavoro sp. 5 cm, in impiallacciato/Worktop 5 cm thick, veneered

Piani di lavoro sp. 5 cm, in cuoio con cuciture/Worktop 5 cm thick, in leather with stitches

ERC ERM ENC

Rovere chiaro/
Light oak
 Rovere Moro/
Dark oak
 Noce Canaletto/
Canaletto walnut

CBI CNE CTM

Cuoio bianco/
White hard leather
 Cuoio nero/
Black hard leather
 Cuoio testa di moro/
Dark brown hard leather

Piani di lavoro sp. 0.5 cm, in vetro retrolaccato /
Worktops 0.5 cm thick, rear-lacquered glass

Piani di lavoro sp. 0.5 cm, in vetro temprato retrolaccato acidato con bordi perimetrali lavorati a filo lucido / Worktops 0.5 cm thick, rear-lacquered and acetated tempered glass with outer polished edges

VW

Bianco/
White

VAN

Nero/
Black

Strutture metalliche/Metal structures

W X A

Bianco/
White
 Alluminio "Brill"/
"Brill" polished
aluminium
 Antracite/
Anthracite

Mobili di servizio/Service units

WL WN NM RC RM RT NO

Bianco lucido/
Glossy white
 Bianco opaco/
Matt white
 Noce "Maroncelli"/
"Maroncelli" walnut
 Rovere chiaro/
Light oak
 Rovere Moro/
Dark oak
 Rovere tabacco/
Tobacco oak
 Nero opaco/
Matt black

Scocca, ripiani sp. 2.5 cm e ante sp. 1.8 cm, in impiallacciato/
Body, shelves 2.5 cm and doors 1.8 cm thick, veneered

ERC ERM ENC

Rovere chiaro/
Light oak
 Rovere Moro/
Dark oak
 Noce Canaletto/
Canaletto walnut

Note

- Prodotti non in pronta consegna. Per la disponibilità contattare l'ufficio commerciale/Items not in prompt delivery. Please contact the commercial department to check availability.
- Fino ad esaurimento/Until exhaustion.

DV905 Rym

Tavoli scrivania/Desks

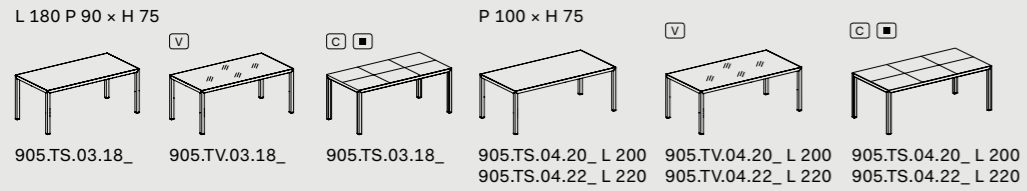

Tavoli per integrazione con mobili di servizio /Desk for integration with service units

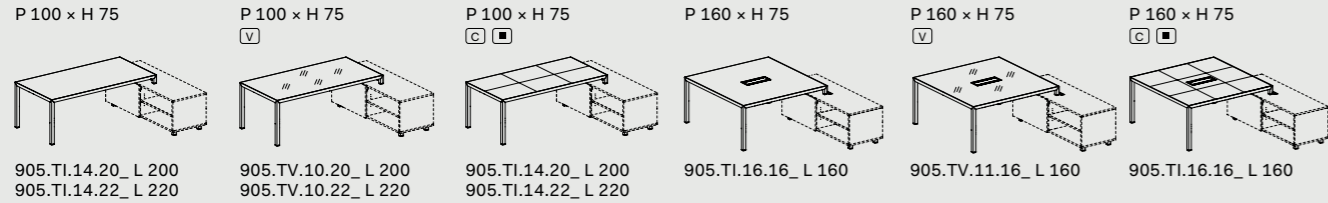

Mobili di servizio e cassetteria interna /Service units and internal pedestal

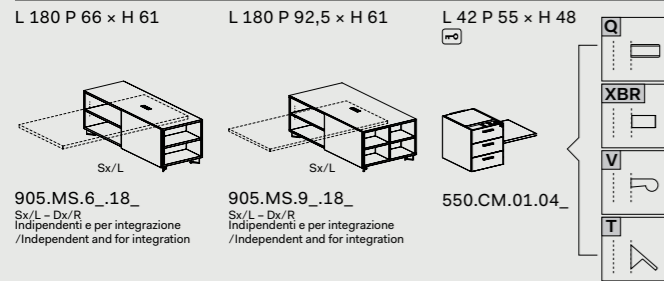

Modesty panels

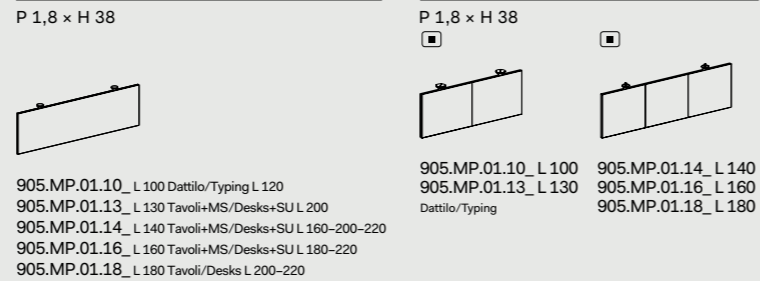

Tavoli scrivania L 200 x P 100 con mobile di servizio L 180 x P 66/Desks W 200 x D 100 with service unit W 180 x D 66

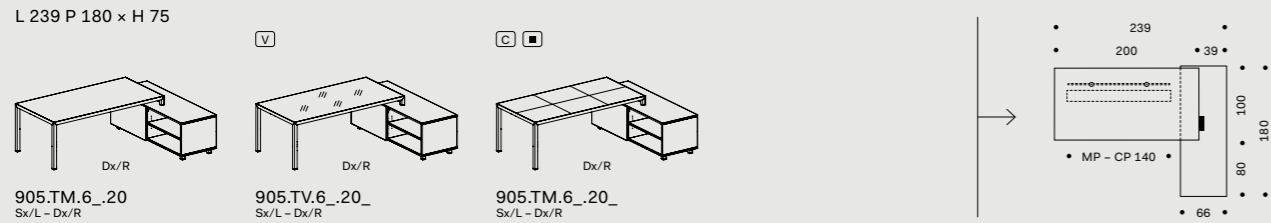

Tavoli scrivania L 220 x P 100 con mobile di servizio L 180 x P 66/Desks W 220 x D 100 with service unit W 180 x D 66

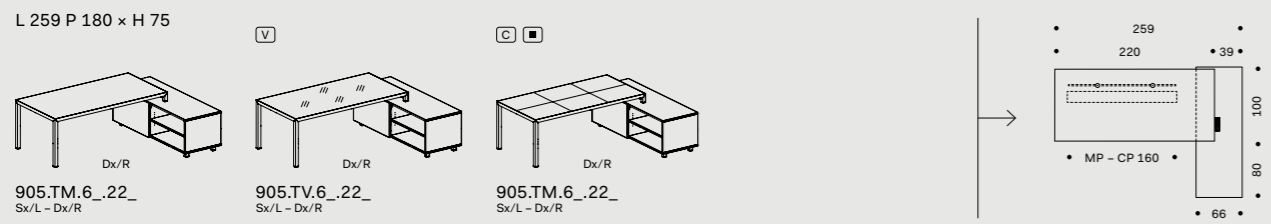

Tavoli scrivania L 200 x P 100 con mobile di servizio L 180 x P 92,5/Desks W 200 x D 100 with service unit W 180 x D 92,5

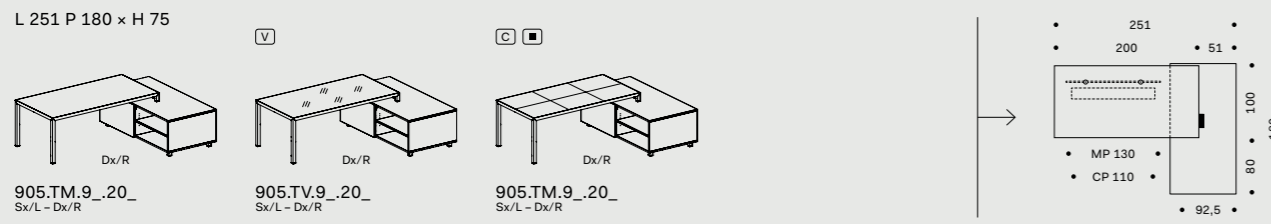

Note:

1 Le finiture impiallacciate e cuoio non sono in pronta consegna. Per la disponibilità contattare l'ufficio commerciale /Veneered and leather finishes are not in prompt delivery. Please contact the commercial department to check availability;

2 Per la scelta dei contenitori e degli accessori vari, consultare il relativo listino o catalogo/To choose storage units and accessories, please check correspondent price list or catalogue;

3 I tavoli possono essere montati sui mobili di servizio P 66 e P 92,5 cm (destri o sinistri). Per ogni soluzione compositiva è disponibile a listino la dimensione del corrispondente modesty panel (vedi relativa quota indicata con MP) e del corrispondente canale passacavi (vedi relativa quota indicata con CP)/The desks can be fixed on the service units depth 66 and depth 92,5 cm (right or left hand). To order the modesty panel please check the dimensions marked with MP and the dimensions marked with CP for the relevant cables channel;

Dati tecnici / Technical data

Tavoli e allunghi dattilo /Typing and extension tables

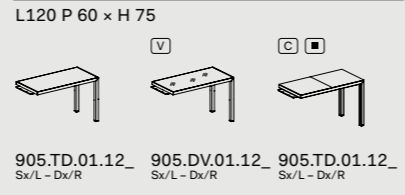

DV905 Rym

Tavoli scrivania L 220 x P 100 con mobile di servizio L 180 x P 92,5/Desks W 220 x D 100 with service unit W 180 x D 92,5

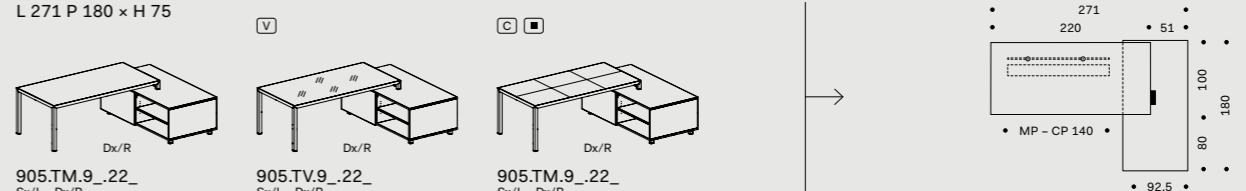

Tavoli scrivania L 160 x P 160 con mobile di servizio L 180 x P 66/Desks W 160 x D 160 with service unit W 180 x D 66

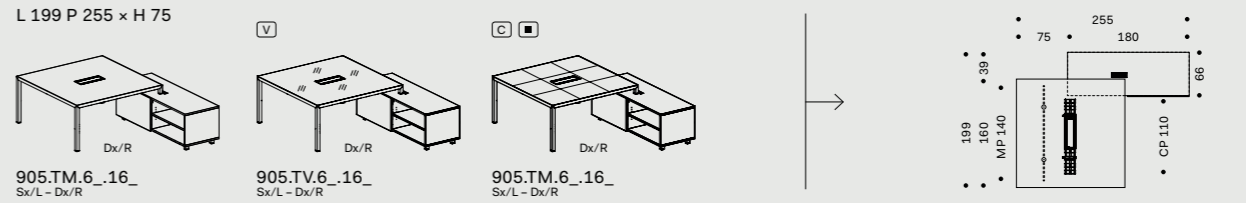

Tavoli scrivania L 160 x P 160 con mobile di servizio L 180 x P 92,5 /Desks W 160 x D 160 with service unit W 180 x D 92,5

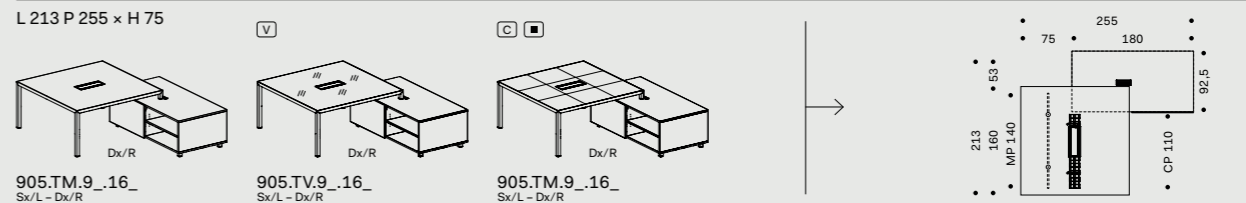

Tavoli riunione/Meeting tables

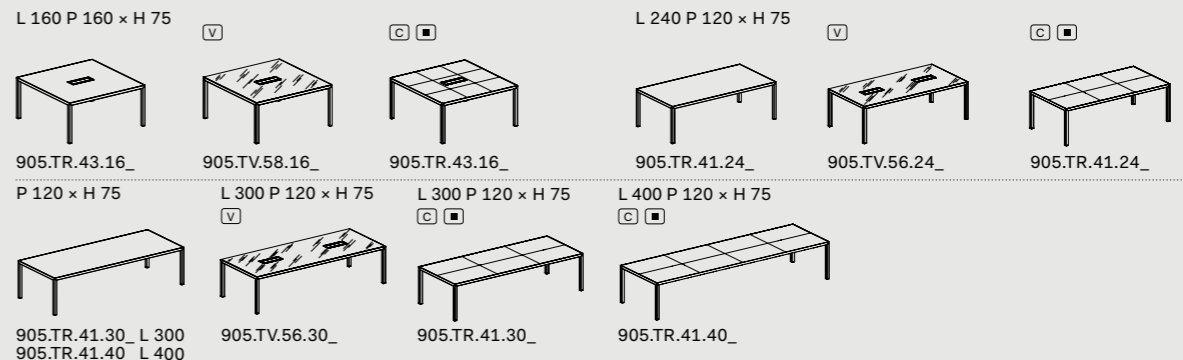

Cassettiere su ruote/Pedestals on castors

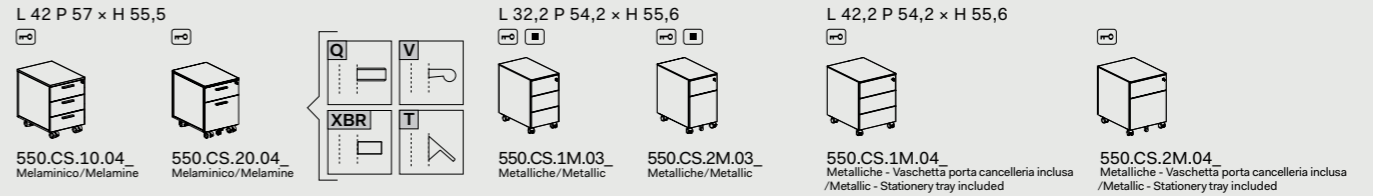

Note: La finitura impiallacciato non è in pronta consegna. Per la disponibilità contattare l'ufficio commerciale. Per portacassetteria cassetti, vedi capitolo DV300-Accessori /Veneered finishes is not in prompt delivery. Please contact the commercial department to check availability. For stationary tray, see chapter DV300-Accessories.

Accessori per canalizzazione - Elettificazione - Vari/Accessories for wire management - Electrification - Various

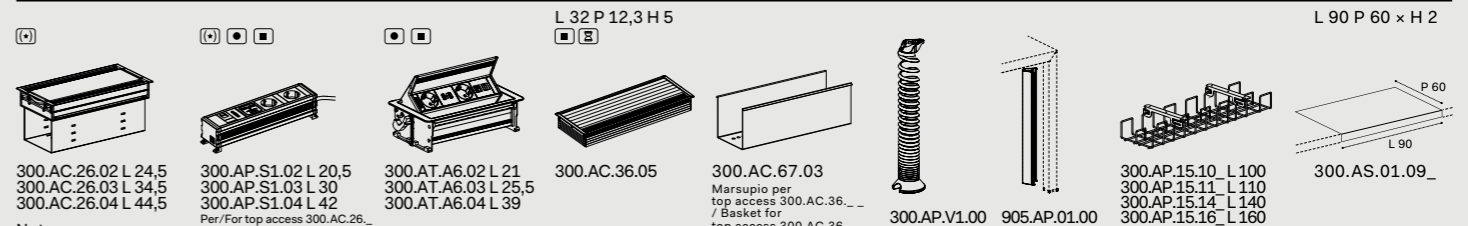

Note:

1 Le dimensioni sono espresse in cm - consultare il listino prezzi per le caratteristiche tecniche, i codici degli articoli e delle finiture/Dimensions are stated in cm - for technical characteristics, article code numbers and finishing see price list;

2 Prodotti non in pronta consegna. Per la disponibilità contattare l'ufficio commerciale/Items not in prompt delivery. Please contact the commercial department to check availability;

3 Articoli prodotti solo su richiesta/Items produced; only on demand;

4 Con serratura/With lock; V Vetro/Glass;

5 Cuoio/Leather.

6 Fino ad esaurimento/Until exhaustion.

DV908 Rodi

Design:
Antonio Morello

Comp. N°1 - 2

IT Geometrie in equilibrio – Tavoli con gambe e piani in “metallo verniciato”, sono disponibili in cinque diverse finiture e si adattano ai molteplici ambienti di lavoro.

EN Balanced geometries – Desks, with legs and worktops in “painted metal”, are available in 5 different finishes and are adaptable to multiple work environments.

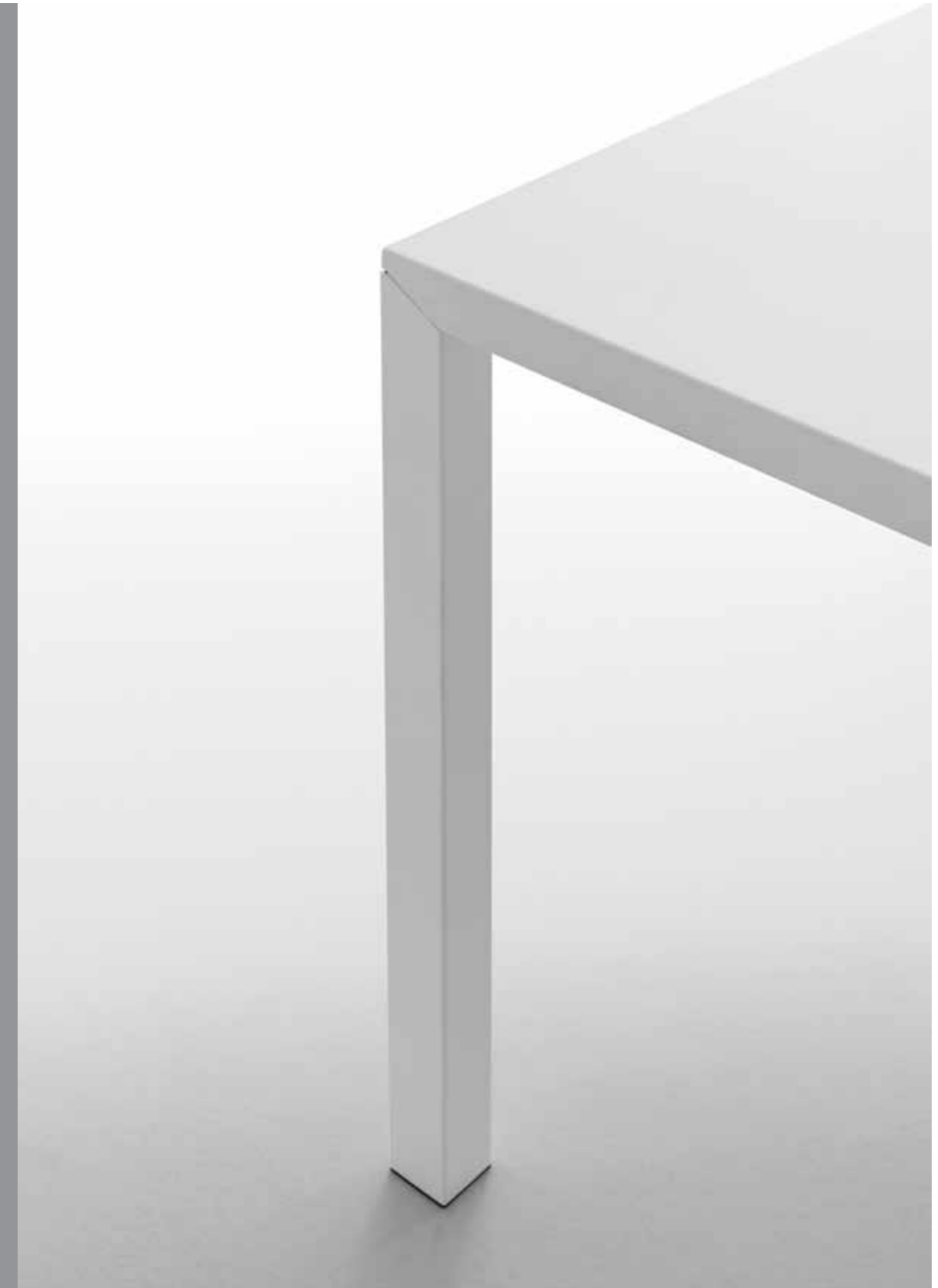
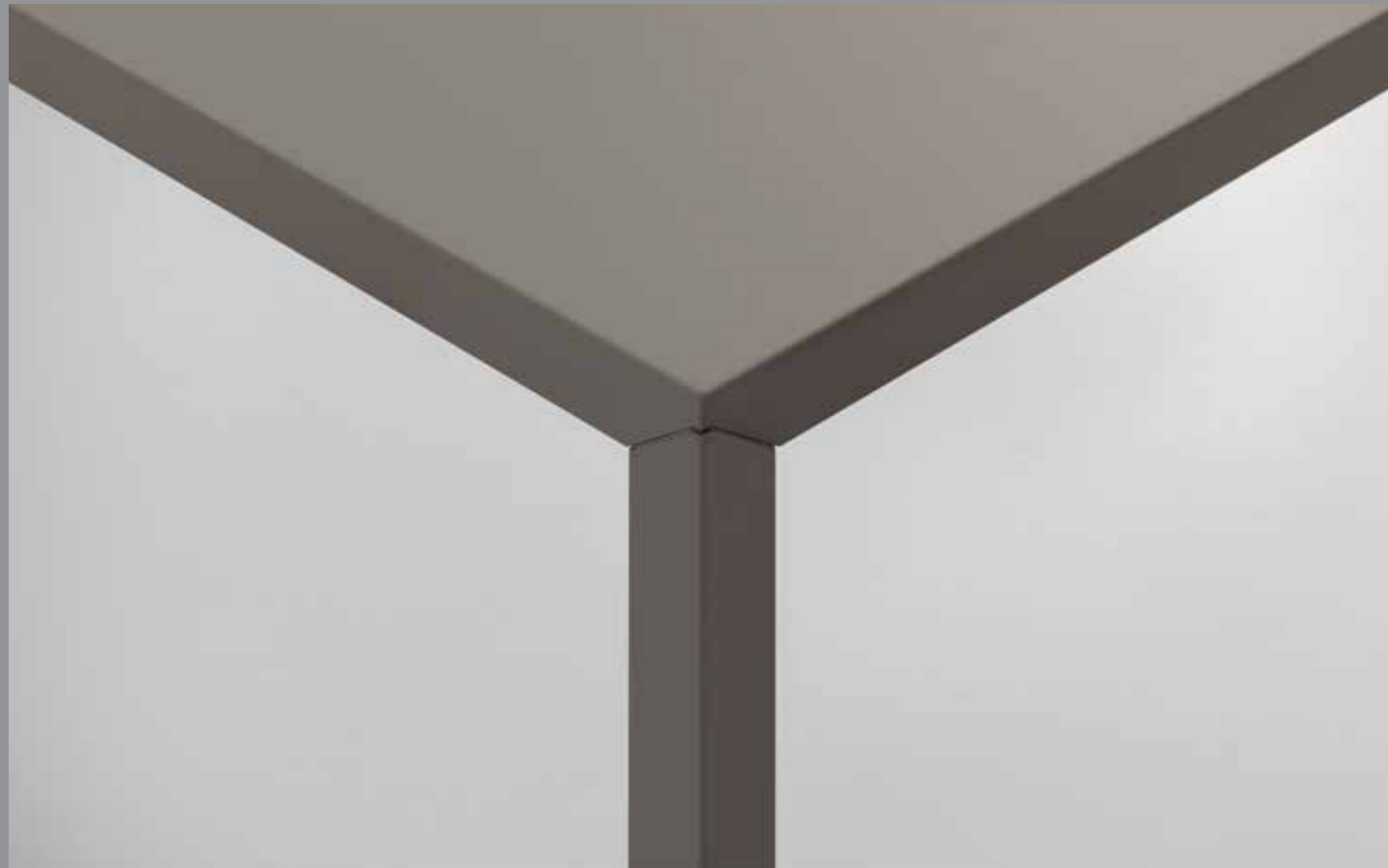





Tavoli/Tables

Piani di lavoro in metallo verniciato, sp. 4 cm/Metal painted worktops, 4 cm thick



Strutture metalliche/Metal structures



Tavoli riunione/Meeting tables

L 200 P 100 x H 75

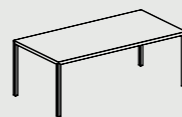

908.TR.42.20_

L 240 P 120 x H 75

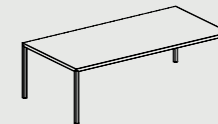

908.TR.41.24_

L 200 P 100 x H 75

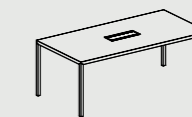

908.TR.48.20_

L 240 P 120 x H 75

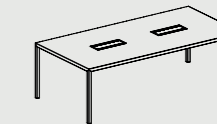

908.TR.47.24_

Note: Top access 300.AC.20.04 incluso / Top access 300.AC.20.04 included

Note: Top access 300.AC.20.04 incluso / Top access 300.AC.20.04 included

Accessori per canalizzazione - Elettificazione / Accessories for wire management - Electrification

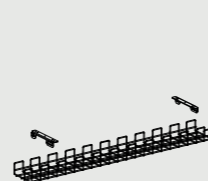

300.AP.15.11 L 110
300.AP.15.14 L 140
300.AP.15.16 L 160



300.AC.25.04 L 43,5

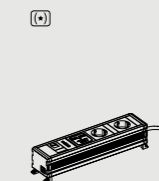

300.AP.S1.02 L 20,5
300.AP.S1.03 L 30
300.AP.S1.04 L 42
Per/For top access 300.AC.26_



300.AP.V1.00

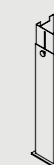

300.AP.V2.15

Note

Prodotti non in pronta consegna. Per la disponibilità contattare l'ufficio commerciale/Items not in prompt delivery. Please contact the commercial department to check availability.

Note:

1) Per la scelta dei contenitori e degli accessori vari, consultare il relativo listino o catalogo/To choose storage units and accessories, please check correspondent price list or catalogue;

Prodotti non in pronta consegna. Per la disponibilità contattare l'ufficio commerciale/Items not in prompt delivery. Please contact the commercial department to check availability;

2) Le dimensioni sono espresse in cm - consultare il listino prezzi per le caratteristiche tecniche, i codici degli articoli e delle finiture/Dimensions are stated in cm - for technical characteristics, article code numbers and finishing see price list;

Articoli prodotti solo su richiesta/Items produced only on demand.

DV903 Tay

Design:
Perin&Topan

Comp. N°1

IT Perfetta sintesi tra funzione e design – Una collezione di grande impatto estetico, dove la ricchezza dei piani di lavoro e la preziosità delle finiture generano una perfetta sintesi tra funzione e design, tra eleganza e tecnologia. I materiali nobili sapientemente accostati, gli intarsi spazzolati lucidi, la scelta attenta di colori ed essenze riportano alla tradizione artigiana e soprattutto all'alta classe degli arredi direzionali.

EN Perfect synthesis between function and design – A collection of great aesthetic impact, where the luxury of the worktops and the preciousness of the finishes create perfect balance between functionality and design, between elegance and technology. Fine materials wisely combined, polished inlays, careful colours and wood choices let handmade traditions emerge and, most of all, lead back to the high class of executive furnishings.







DV903 Tay

Design:
Perin&Topan

Comp. N°2





DV903 Tay

Design:
Perin&Topan

Comp. N°3





DV903 Tay

Design:
Perin&Topan

Comp. N°4







Tavoli/Tables

Piani di lavoro sp. 1 cm, in vetro temprato retrolaccato con bordi perimetrali lavorati a filo lucido/Worktops 1 cm thick, rear-lacquered tempered glass with outer polished edges

Piani di lavoro sp. 1 cm, in vetro temprato retrolaccato acidato con bordi perimetrali lavorati a filo lucido/Worktops 1 cm thick, rear-lacquered and acetated tempered glass with outer polished edges

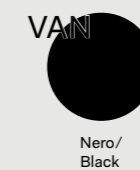
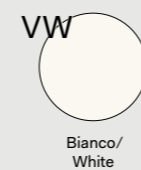

Piani di lavoro sp. 1.2 cm, in vetro fumé temprato con bordi perimetrali lavorati a filo lucido/Worktops 1.2 cm thick, smoked grey tempered glass with outer polished edges

Piano di lavoro in vetro temprato trasparente sp. 0.8 cm, accoppiato con piano in gres porcellanato sp. 0.6 cm/Worktop in 0.8 cm thick transparent tempered glass, coupled with a 0.6 cm thick porcelain stoneware worktop

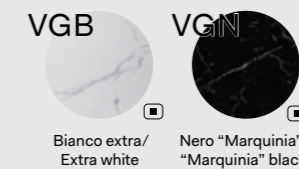

Gambe metalliche / Metal legs

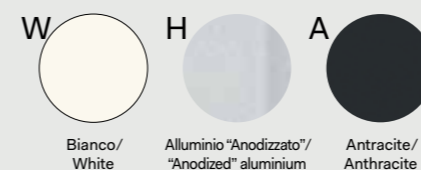

Mobili di servizio/Service units

Scocca, ripiani sp. 2.5 cm e ante sp. 1.8 cm, in melaminico ☒ o laminato ☒☒ / Body, shelves 2.5 cm and doors 1.8 cm thick, in melamine ☒ or laminate ☒☒

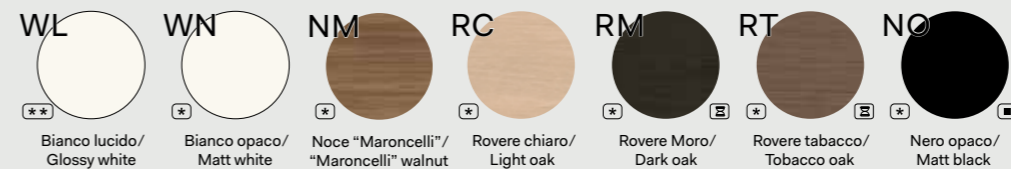

Scocca, ripiani sp. 2.5 cm e ante sp. 1.8 cm, in impiallacciato/ Body, shelves 2.5 cm and doors 1.8 cm thick, veneered

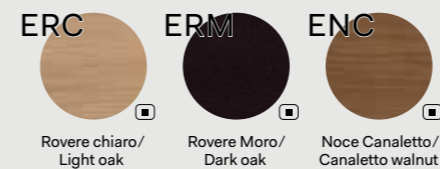

Note

☐ Prodotti non in pronta consegna. Per la disponibilità contattare l'ufficio commerciale/Items not in prompt delivery. Please contact the commercial department to check availability.
☒ Fino ad esaurimento/Until exhaustion.

Tavoli scrivania in vetro/Glass tables

P 100 x H 75 V	P 60 x H 75 V	V
903.TV.07.20_ L 200	903.TV.05.10_ L 100	903.TV.04.10_ L 100

Tavoli scrivania in gres/Gres tables

P 100 x H 75 G	P 60 x H 75 G	G
903.TV.07.20_ L 200	903.TV.05.10_ L 100	903.TV.04.10_ L 100

Tavoli per integrazione con mobili di servizio /Desk for integration with service units

P 100 x H 75 V	P 100 x H 75 G	P 160 x H 75 V
903.TV.09.20_ L 200	903.TV.09.20_ L 200	903.TV.20.16_ L 160

Tavoli scrivania in vetro L 200 con mobile di servizio P 66 (Dx o Sx)/Glass desks L 200 with service unit D 66 (R or L)

L = L 11 - L 12 - L 13 P 180 x H 75

V	G	
903.TV.6_20_ Sx/L - Dx/R	903.TV.6_20_ Sx/L - Dx/R	

Tavoli scrivania in vetro L 200 con mobile di servizio P 92,5 (Dx o Sx)/Glass desks L 200 with service unit D 92,5 (R or L)

L = L 14 - L 15 - L 16 P 180 x H 75

V	G	
903.TV.9_20_ Sx/L - Dx/R	903.TV.9_20_ Sx/L - Dx/R	

Tavoli scrivania - riunioni in vetro L 160x160 con mobile di servizio P 66 - 92,5 (Dx o Sx) /Glass desks - meeting tables L 160x160 with service unit D 66 - 92,5 (R or L)

L = L 17 P 250 x H 75 V	L = L 18 P 250 x H 75 V
903.TV.6_20_ Sx/L - Dx/R	903.TV.9_20_ Sx/L - Dx/R

Tavoli riunione in vetro/Glass meeting tables

Ø 100 x H 75 V	P 160 x H 75 V	P 120 x H 75 V
903.TV.14.10_ 903.TV.15.10_	903.TV.38.16_ L 160	903.TV.56.24_ L 240

Tavoli riunione in gres/Gres meeting tables

Ø 100 x H 75 G	P 140 x H 75 G	P 120 x H 75 G
903.TV.14.10_ 903.TV.15.10_	903.TV.38.14_ L 14	903.TV.56.24_ L 240

Mobili di servizio e cassettera interna /Service units and internal pedestal

L 180 P 66 x H 61	L 180 P 92,5 x H 61	L 42 P 55 x H 48
903.MS.6_18_ Sx/L - Dx/R Indipendenti e per integrazione /Independent and for integration	903.MS.9_18_ Sx/L - Dx/R Indipendenti e per integrazione /Independent and for integration	550.CM.01.04_

Canalizzazione in tondino d'acciaio e modesty panels per tavoli in vetro /Wire management with steel rod channels and modesty panels for tables with glass tops

903.AP.15.10_ L 78 Tavoli/Desks L 100 903.AP.15.16_ L 140 Tavoli/Desks L 160 903.AP.15.20_ L 160 Tavoli/Desks 200 903.AP.15.24_ L 160 Tavoli/Desks 240	903.MP.04.12_ L 120 Tavoli + MS/Desks + SU L 200 903.MP.04.14_ L 140 Tavoli + MS/Desks + SU L 200 903.MP.04.16_ L 160 Tavoli + MS/Desks + SU L 200 903.MP.04.10_ L 100 Tavoli + MS/Desks + SU L 160 903.MP.05.16_ L 140 Tavoli/Desks L 160 903.MP.05.20_ L 180 Tavoli/Desks L 200	903.MP.07.20_ L 180 Tavoli/Desks L 200 903.MP.07.16_ L 140 Tavoli/Desks L 160 903.MP.07.12_ L 120 Tavoli + MS/Desks + SU L 200 903.MP.07.14_ L 140 Tavoli + MS/Desks + SU L 200 903.MP.07.18_ L 160 Tavoli + MS/Desks + SU L 200 903.MP.07.10_ L 100 Tavoli + MS/Desks + SU L 160

Cassettiere/Pedestals

L 42 P 57 x H 55,5	L 32,2 P 54,2 x H 55,6	L 42,2 P 54,2 x H 55,6
550.CS.10.04_ Melaminico/Melamine	550.CS.20.04_ Melaminico/Melamine	550.CS.1M.03_ Metalliche/Metallic 550.CS.2M.03_ Metalliche/Metallic 550.CS.1M.04_ Metalliche/Metallic 550.CS.2M.04_ Metalliche/Metallic Vaschetta porta cancelleria inclusa /Stationery tray included

Note: La finitura impiallacciato non è in pronta consegna. Per la disponibilità contattare l'ufficio commerciale. Per portacancelleria cassetti, vedi capitolo DV300-Accessori/Veneered finishes is not in prompt delivery. Please contact the commercial department to check availability. For stationary tray, see chapter DV300-Accessories.

Accessori per canalizzazione - Elettrificazione - Vari /Accessories for wire management - Electrification - Various

300.AC.26.02 L 24,5 300.AC.26.03 L 34,5 300.AC.26.04 L 44,5	300.AP.S1.02 L 20,5 300.AP.S1.03 L 30 300.AP.S1.04 L 42 Per/For top access 300.AC.26_	300.AT.A6.02 L 21 300.AT.A6.03 L 25,5 300.AT.A6.04 L 39	300.AC.55.04 L 43,5 Marsupio optional per tavoli in vetro fumè/Optional basket for smoked-grey glass tables	300.APT.7.01 Ø 6 300.APT.8.01 Ø 8	300.APT.2.01 Ø 8 300.AP.V1.00 903.AP.08.00 300.APT.4.01 300.APT.5.01 - UK 300.APT.6.01 - US 300.AP.F1.00

Note:

- Le finiture in gres non sono in pronta consegna. Per la disponibilità contattare l'ufficio commerciale /Gres finishes are not in prompt delivery. Please contact the commercial department to check availability;
- Per la scelta dei contenitori e degli accessori vari, consultare il relativo listino o catalogo/To choose storage units and accessories, please check correspondent price list or catalogue;
- Le dimensioni sono espresse in cm - consultare il listino prezzi per le caratteristiche tecniche, i codici degli articoli e delle finiture/Dimensions are stated in cm - for technical characteristics, article code numbers and finishing see price list;
- I tavoli possono essere montati sui mobili di servizio P 66 e P 92,5 cm (destri o sinistri) scegliendo tra diverse posizioni. Per ogni soluzione compositiva è disponibile a listino la dimensione del corrispondente modesty panel (vedi relativa quota indicata con MP) e del corrispondente canale passacavi (vedi relativa quota indicata con CP)/The desks can be mounted on service units depth 66 and 92,5 cm (right or left hand) in different positions. You can find the proper modesty panel to match according to the composition choosen (see sizes indicated with the MP), while the cable channel is indicated with CP;
- Prodotti non in pronta consegna. Per la disponibilità contattare l'ufficio commerciale/Items not in prompt delivery. Please contact the commercial department to check availability;
- Fino ad esaurimento/Until exhaustion;
- Con serratura/With lock;
- Per eventuali giacenze a magazzino delle precedenti versioni senza top-access, contattare l'ufficio commerciale/To check stock availabilities of table tops without top-access, please contact our commercial department;
- Vetro/Glass; G Gres/Gres.

DV901 Vertigo

Design:
Antonio Morello

Comp. N°1

IT Eleganza nel design e ricercatezza nei dettagli, sono i tratti distintivi di questa collezione, pensata per creare ambienti dove stile e professionalità siano in sintonia con immagine e prestazioni. I tavoli sono gli elementi caratterizzanti, soprattutto per la tecnicità della loro struttura, realizzata con profili e gambe in estrusi di alluminio collegati tra loro mediante particolari giunti cromati. Le gambe sono disponibili con e senza basi.

EN Elegant design and refined details are the distinctive features of this collection, conceived to create environments where style and professionalism are in harmony with image and performance. The desks are the characterizing elements, primarily for the technicality of their structure, made with extruded aluminium profiles and legs, connected with special chromed joints. Legs are available with and without sled base.







DV901 Vertigo

Design:
Antonio Morello

Comp. N°2

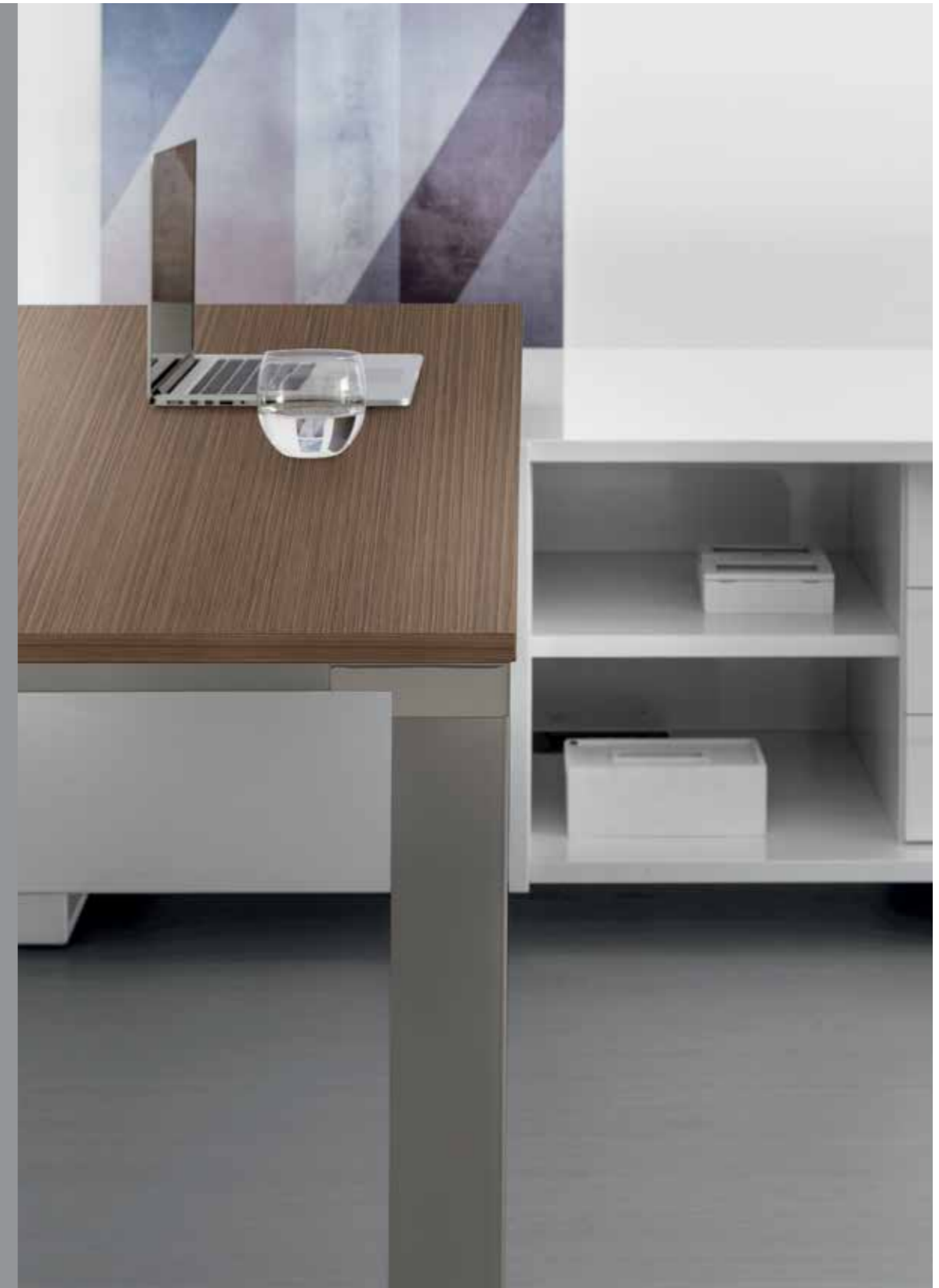



DV901 Vertigo

Design:
Antonio Morello

Comp. N°3

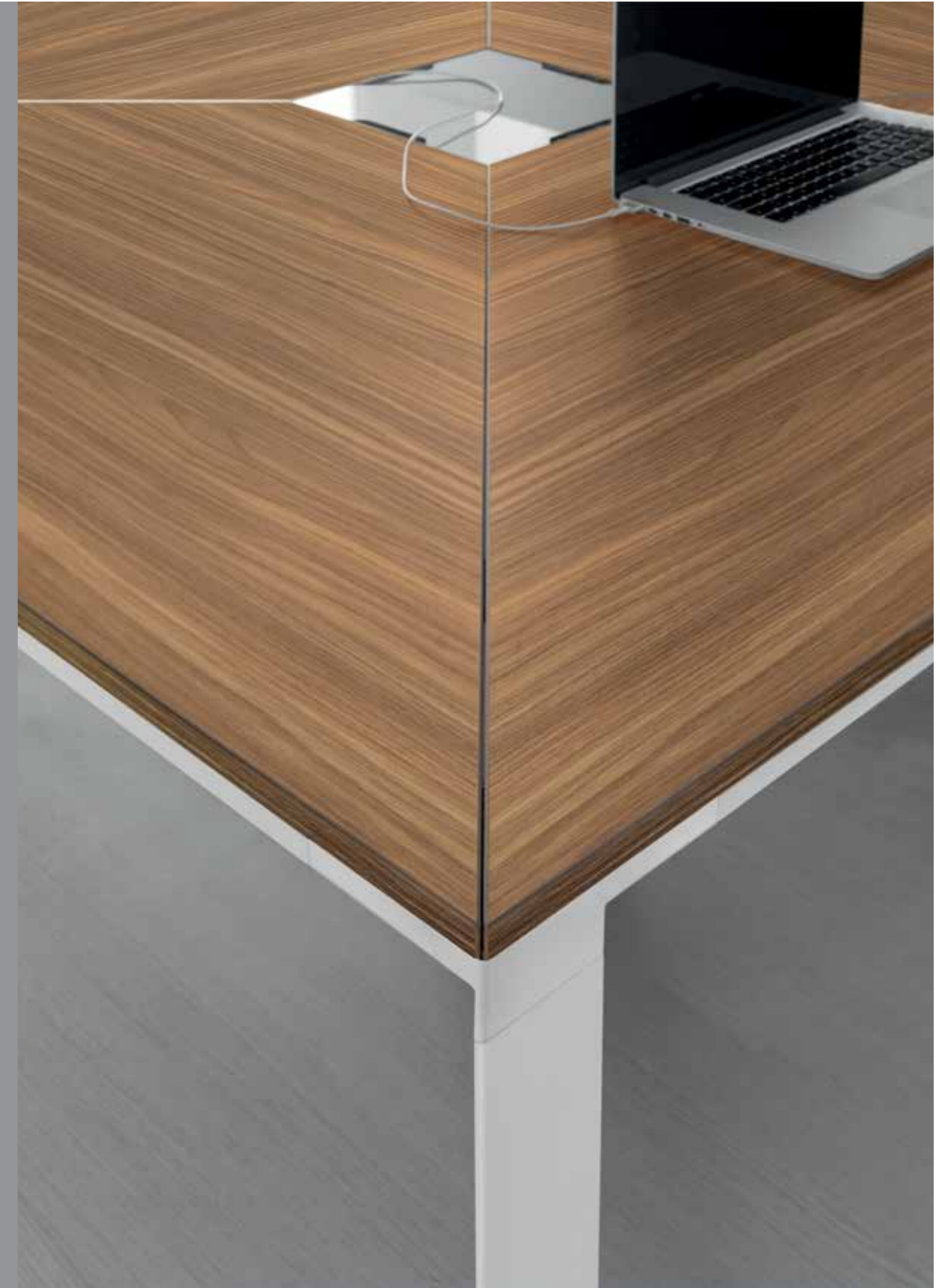





DV901 Vertigo

Design:
Antonio Morello

Comp. N°4





DV901 Vertigo

Design:
Antonio Morello

Comp. N°5









Tavoli/Tables

Piani di lavoro sp. 1.8 cm, in melaminico (*) o laminato (***) con bordi in ABS sp. 0.2 cm / Worktops 1.8 cm thick, in melamine (*) or laminate (***) with ABS edge-profiles 0.2 cm thick

Piani di lavoro sp. 1.8 cm, in impiallacciato / Worktop 1.8 cm thick, veneered

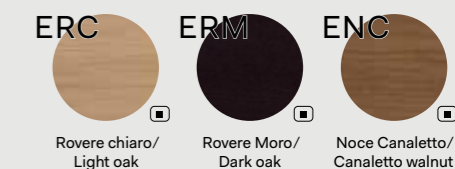

Piani di lavoro sp. 2 cm, in cuoio con cuciture/Worktop 2 cm thick, in leather with stitches

Piani di lavoro sp. 1 cm, in vetro temprato retrolaccato con bordi perimetrali lavorati a filo lucido / Worktops 1 cm thick, rear-lacquered tempered glass with outer polished edges

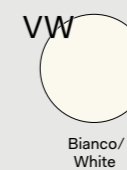

Piani di lavoro sp. 1 cm, in vetro temprato retrolaccato acidato con bordi perimetrali lavorati a filo lucido / Worktops 1 cm thick, rear-lacquered and acetated tempered glass with outer polished edges

Piano di lavoro in vetro temprato trasparente sp. 0.8 cm, accoppiato con piano in gres porcellanato sp. 0.6 cm / Worktop in 0.8 cm thick transparent tempered glass, coupled with a 0.6 cm thick porcelain stoneware worktop

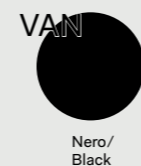

Strutture metalliche/Metal structures



Mobili di servizio/Service units

Scocca, ripiani sp. 2.5 cm e ante sp. 1.8 cm, in melaminico (*) o laminato (***) / Body, shelves 2.5 cm and doors 1.8 cm thick, in melamine (*) or laminate (***)



Scocca, ripiani sp. 2.5 cm e ante sp. 1.8 cm, in impiallacciato / Body, shelves 2.5 cm and doors 1.8 cm thick, veneered

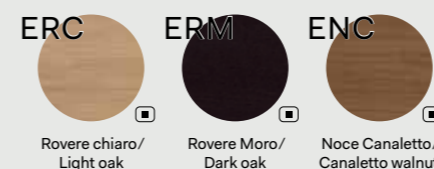

Note

■ Prodotti non in pronta consegna. Per la disponibilità contattare l'ufficio commerciale/Items not in prompt delivery. Please contact the commercial department to check availability.
 ■ Fino ad esaurimento/Until exhaustion.

Tavoli scrivania/Desks

P 90 x H 75		P 90 x H 74,5		P 90 x H 75	
901.TS.48.18_L 180 901.TS.48.20_L 200	901.TS.03.18_L 180 901.TS.03.20_L 200	901.TV.17.18_L 180 901.TV.17.20_L 200	901.TV.01.18_L 180 901.TV.01.20_L 200	901.TS.48.18_L 180 901.TS.48.20_L 200	901.TS.03.18_L 180 901.TS.03.20_L 200
P 90 x H 74,5		L 160 P 80 x H 75		L 160 P 80 x H 74,5	
901.TV.17.18_L 180 901.TV.17.20_L 200	901.TV.01.18_L 180 901.TV.01.20_L 200	901.TS.02.16_	901.TV.15.16_	901.TS.02.16_	

Tavoli dattilo/Typing tables

L 120 P 60 x H 75		L 120 P 60 x H 74,5		L 120 P 60 x H 75		L 120 P 60 x H 75	
901.TS.50.12_	901.TS.44.12_	901.TV.19.12_	901.TV.16.12_	901.TS.50.12_	901.TS.44.12_	901.TV.19.12_	901.TV.16.12_

Tavoli riunione/Meeting tables

Ø 100 x H 74,5	Ø 100 x H 75	L 100 P 100 x H 75	L 100 P 100 x H 74,5	L 100 P 100 x H 75	L 160 P 160 x H 75	L 160 P 160 x H 74,5	L 160 P 160 x H 75
901.TV.15.10_	901.TV.15.10_	901.TR.42.10_	901.TV.77.10_	901.TR.42.10_	901.TV.77.10_	901.TR.43.16_	901.TV.38.16_
L 140 P 140 x H 75,5	L 160 P 160 x H 75	L 240 P 120 x H 75		L 240 P 120 x H 74,5	L 240 P 120 x H 75	L 240 P 120 x H 75,5	
901.TV.38.14_	901.TR.51.16_	901.TR.51.16_	901.TR.41.24_	901.TV.36.24_	901.TR.41.24_	901.TV.36.24_	

Allunghi per tavoli scrivania L 160 - 180/Extension tables for desks L 160 - 180

L 120 P 60 x H 75		L 120 P 60 x H 74,5		L 120 P 60 x H 75		L 120 P 60 x H 75	
901.TD.31.12_Dx/R 901.TD.33.12_Sx/L	901.TD.30.12_Dx/R 901.TD.32.12_Sx/L	901.TV.22.12_Dx/R 901.TV.24.12_Sx/L	901.TV.21.12_Dx/R 901.TV.23.12_Sx/L	901.TV.22.12_Dx/R 901.TV.24.12_Sx/L	901.TV.21.12_Dx/R 901.TV.23.12_Sx/L	901.TD.31.12_Dx/R 901.TD.33.12_Sx/L	901.TD.30.12_Dx/R 901.TD.32.12_Sx/L

Allunghi per tavoli scrivania L 200/Extension tables for desks L 200

L 120 P 60 x H 75		L 120 P 60 x H 74,5		L 120 P 60 x H 75		L 120 P 60 x H 75	
901.TD.27.12_	901.TD.26.12_	901.TV.20.12_	901.TV.04.12_	901.TV.20.12_	901.TV.04.12_	901.TD.27.12_	901.TD.26.12_

Tavoli composti/Compound desks

L 200 P 90 x H 75					
901.TS.53.20_	901.TS.54.20_	901.TS.53.20_	901.TS.55.20_	901.TS.56.20_	901.TS.55.20_

Tavoli riunione componibili con gambe centrali rientrate/Modular meeting tables with central recessed legs

L 320 P 80 x H 75		P 90 x H 75		L 320 P 160 x H 75	
901.TR.55.32_	901.TR.55.32_	901.TR.55.36_L 360 901.TR.55.40_L 400	901.TR.55.36_L 360 901.TR.55.40_L 400	901.TR.55.40_L 400	901.TR.55.40_L 400
L 320 P 160 x H 75		L 480 P 160 x H 75		L 480 P 160 x H 75	
901.TV.47.32_	901.TR.32.32_	901.TR.52.32_	901.TR.52.32_	901.TR.32.48_	901.TR.32.48_
L 480 P 160 x H 75		L 480 P 160 x H 75		L 480 P 160 x H 75	
901.TV.47.48_	901.TR.32.48_	901.TR.52.48_	901.TR.52.48_	901.TR.52.48_	901.TR.52.48_

Elementi per tavoli riunione componibili con gambe centrali rientrate/Modular elements for compound meeting tables with central recessed legs

L 160 P 80 x H 75		P 90 x H 75		L 160 P 160 x H 74,5	
901.TR.55.16_	901.TR.55.16_	901.TR.55.18_L 180 901.TR.55.20_L 200	901.TR.55.18_L 180 901.TR.55.20_L 200	901.TR.55.20_L 200	901.TR.55.20_L 200
L 160 P 160 x H 75		L 160 P 160 x H 75		L 160 P 160 x H 75,5	
901.TR.32.16_	901.TR.32.16_	901.TR.52.16_	901.TR.52.16_	901.TV.47.16_	901.TV.47.16_

Tavoli per integrazione con mobili di servizio/Desks for integration with service units

P 90 x H 75		P 90 x H 74,5		P 90 x H 75		P 90 x H 75		L 160 P 160 x H 75		L 160 P 160 x H 74,5	
901.TI.15.18_L 180 901.TI.15.20_L 200	901.TV.11.18_L 180 901.TV.11.20_L 200	901.TV.11.18_L 180 901.TV.11.20_L 200	901.TI.15.18_L 180 901.TI.15.20_L 200	901.TI.15.18_L 180 901.TI.15.20_L 200	901.TI.16.16_Dx/R 901.TI.17.16_Sx/L	901.TV.22.16_Dx/R 901.TV.23.16_Sx/L					

Note:

- Le finiture impiallacciato, gres e cuoio non sono in pronta consegna. Per la disponibilità contattare l'ufficio commerciale/Veneered, porcelain stoneware and leather finishes are not in prompt delivery. Please contact the commercial department to check availability;
- Le dimensioni sono espresse in cm - consultare il listino prezzi per le caratteristiche tecniche, i codici degli articoli e delle finiture/Dimensions are stated in cm - for technical characteristics, article code numbers and finishing see price list;
- Prodotti non in pronta consegna. Per la disponibilità contattare l'ufficio commerciale/Items not in prompt delivery. Please contact the commercial department to check availability;
- Fino ad esaurimento/Until exhaustion;
- Per eventuali giacenze a magazzino delle precedenti versioni senza top-access, contattare l'ufficio commerciale/To check stock availabilities of table tops without top-access, please contact our commercial department;
- Vetro/Glass; Cuoio/Leather; Gres/Gres;
- Eco-Pelle/Eco-Leather;
- Allunghi montabili anche in posizione centrale sui tavoli scrivania L 160 - 180 - 200 (vedere listino)/Extensions suitable also for central position on desks L 160 - 180 - 200 (see price list);
- Tavoli scrivania con piani composti/Desks with compound worktops.

DV901 Vertigo

Tavoli per integrazione con mobili di servizio / Desks for integration with service units

L 160 P 160 x H 75

901.TI.16.16_ Dx/R
901.TI.17.16_ Sx/L

901.TI.18.16_ Dx/R
901.TI.19.16_ Sx/L

901.TI.18.16_ Dx/R
901.TI.19.16_ Sx/L

Mobili di servizio e cassetteria interna / Service desks and internal pedestals

L 180 P 66 x H 63 L 180 P 92,5 x H 63 L 42 P 55 x H 48

901.MS.6_18_ Dx/R - Sx/L
901.MS.9_18_ Dx/R - Sx/L

550.CM.01.04_

Indipendenti e per integrazione / Independent and for integration

Esempi posizionamento tavoli riunione P 90 con mobili di servizio / Examples of meeting tables D 90 positioning with service units

L 180 x H 75 L 200 x H 75

L 1 = 219 L 2 = 231

L 3 = 239 L 4 = 251

CP 140 CP 140

MP 120 MP 140

Esempi posizionamento tavoli riunione L 160 con mobili di servizio / Examples of meeting tables W 160 positioning with service units

P 160 x H 75

L 5 = 199 L 6 = 213

L 7 = 199 L 8 = 213

MP - CP 140 MP - CP 140

Modesty panel - Canalizzazione per tavoli scrivanie / Modesty panel - Wire management for desks

901.MP.01.16_ L 140 (160x80)
901.MP.01.18_ L 160 (180x90)
901.MP.01.20_ L 180 (200x90)
901.MP.11.16_ L 140 (160x160) (L 5 - L 6)

901.AP.15.16_ L 140 (160x80) X
901.AP.15.18_ L 160 (180x90) X
901.AP.15.20_ L 180 (200x90) X
901.AP.24.12_ L 160 (240x120) X
901.AP.12.06_ L 140 (120x60) Y
901.AP.17.16_ L 140 (160x160) (L 5 - L 6)
901.AP.18.16_ L 140 (160x160) (L 7 - L 8) Z

Modesty panel - Canalizzazione per tavoli scrivanie su mobili di servizio / Modesty panel - wire management for desks on service units

901.AP.22.18_ L 140 (180x90) (L 1 - L 2)
901.AP.22.20_ L 160 (200x90) (L 3 - L 4)
901.AP.17.16_ L 140 (160x160) (L 5 - L 6)
901.AP.18.16_ L 140 (160x160) (L 7 - L 8) Z

901.MP.08.12_ L 120 (L 1 - L 2)
901.MP.11.16_ L 140 (160x160) (L 5 - L 6)
901.MP.09.14_ L 140 (L 3 - L 4)
Per tavoli scrivania L 200 / For desks W 200

901.AP.21.18_ (L 1 - L 2)
901.AP.21.20_ (L 3 - L 4)
Da abbinare a modesty panel / To be used with modesty panel

901.MP.12.16_ L 140 (160x160) (L 5 - L 6)

Dati tecnici / Technical data

DV901 Vertigo

Modesty panel in cuoio per tavoli scrivanie / Leather modesty panel for desks

901.MP.01.16_ L 140 (160x80)
901.MP.01.18_ L 160 (180x90)
901.MP.01.20_ L 180 (200x90)
901.MP.11.16_ L 140 (160x160) (L 5 - L 6)

901.MP.06.16_ L 140 (160x80)
901.MP.06.18_ L 160 (180x90)
901.MP.06.20_ L 180 (200x90)
901.MP.12.16_ L 140 (160x160) (L 5 - L 6)

901.MP.08.12_ L 120 (180x90) (L 1 - L 2)

901.MP.09.14_ L 140 (200x90) (L 3 - L 4)
901.MP.11.16_ L 140 (160x160) (L 5 - L 6)

Mobili di servizio / Service units

L 120 P 60 x H 61,5

550.CM.S0.12_ Su ruote / On castors

Cassettiere / Pedestals

L 42 P 57 x H 55,5 L 32,2 P 54,2 x H 55,6 L 42,2 P 54,2 x H 55,6

550.CS.10.04 Melaminico / Melamine
550.CS.20.04 Melaminico / Melamine

550.CS.1M.03 Metalliche / Metallic
550.CS.2M.03 Metalliche / Metallic
550.CS.1M.04 Metalliche - Vaschetta porta cancelleria inclusa / Metallic - Stationery tray included
550.CS.2M.04 Metalliche - Vaschetta porta cancelleria inclusa / Metallic - Stationery tray included

Accessori / Accessories

L 90 P 60 x H 2

300.AS.01.09_

Note: La finitura impiallacciato non è in pronta consegna. Per la disponibilità contattare l'ufficio commerciale. Per portacancelleria cassetti, vedi capitolo DV300-Accessori/Veneered finishes are not in prompt delivery. Please contact the commercial department to check availability. For stationary tray, see chapter DV300-Accessories.

Accessori per canalizzazione - Elettificazione - Vari / Accessories for wire management - Electrification - Various

300.AC.26.02 L 24,5
300.AC.26.03 L 34,5
300.AC.26.04 L 44,5

300.AP.S1.02 L 20,5
300.AP.S1.03 L 30
300.AP.S1.04 L 42
Per/For top access 300.AC.26_

300.AT.A6.02 L 21
300.AT.A6.03 L 25,5
300.AT.A6.04 L 39

L 32 x P 12,3

300.AC.38.02_ H 2,4

300.AC.67.03 Marsupio per top access
300.AC.36_ 300.AC.38_ / Basket for top access
300.AC.36_ 300.AC.38_

300.AP.T4.01
300.AP.T5.01 - UK
300.AP.T6.01 - US

300.AP.T8.11
300.AP.T8.14
300.AP.T8.17
300.AP.T8.20

300.APT2.01 Ø 8

300.APT7.01 Ø 6
300.APT8.01 Ø 8

300.AC.16.02_

300.AP.V2.15

300.AP.V1.00

300.AC.06.05_

300.AC.04.01 Braccio porta video mobile su piano / Dynamic arm for video support on deskbase

300.AC.04.02 Doppio braccio porta video mobile su piano / 2 dynamic arms for video support on deskbase

300.AC.03.01 Braccio porta video statico su palo / Dynamic arm for video support on deskbase

300.AC.03.02 Doppio braccio porta video statico su palo / 2 Static arms for video support on pole

300.AC.02.01 Braccio porta video mobile su piano / Dynamic arm for video support on deskbase

300.AC.02.02 Doppio braccio porta video mobile su piano / 2 dynamic arms for video support on deskbase

300.AC.01.01 Braccio porta video statico su palo / Static arm for video support on pole

300.AC.01.02 Doppio braccio porta video statico su palo / 2 Static arms for video support on pole

Note:

1 Le finiture impiallacciato e cuoio non sono in pronta consegna. Per la disponibilità contattare l'ufficio commerciale / Veneered and leather finishes are not in prompt delivery. Please contact the commercial department to check availability;

2 Le dimensioni sono espresse in cm - consultare il listino prezzi per le caratteristiche tecniche, i codici degli articoli e delle finiture / Dimensions are stated in cm - for technical characteristics, article code numbers and finishing see price list;

3 Per la scelta dei contenitori e degli accessori vari, consultare il relativo listino o catalogo / To choose storage units and accessories, please check correspondent price list or catalogue;

Prodotti non in pronta consegna. Per la disponibilità contattare l'ufficio commerciale / Items not in prompt delivery. Please contact the commercial department to check availability;

Articoli prodotti solo su richiesta / Items produced only on demand;

Per eventuali giacenze a magazzino delle precedenti versioni senza top-access, contattare l'ufficio commerciale / To check stock availabilities of table tops without top-access, please contact our commercial department;

Vetro / Glass; Cuoio / Leather;

Con serratura / With lock;

Tavoli scrivania con piani composti / Desks with compound worktops.

Fino ad esaurimento / Until exhaustion;

DV902 Planeta

Design:
Antonino D'agostino

Comp. N°1

IT La collezione accogliente e confortevole, si esalta attraverso le svariate finiture cromatiche disponibili, che rendono questa serie attuale e senza tempo. Una linea direzionale elegante e minimale che si distingue per la funzionalità e le diverse profondità dei mobili di servizio portanti. Completano la collezione i tavoli riunione, le cassettiere e i contenitori universali.

EN Cosy and comfortable collection, exalted through a number of available colours and finishes that make this series alive and timeless. This elegant, minimalist executive range stands out for its functionality and for the different depths of the carrying service units. Meeting tables, pedestals and universal storage units complete the collection.





DV902 Planeta

Design:
Antonino D'agostino

Comp. N°2





DV902 Planeta

Design:
Antonino D'agostino

Comp. N°3







DV902 Planeta

Design:
Antonino D'agostino

Comp. N°4

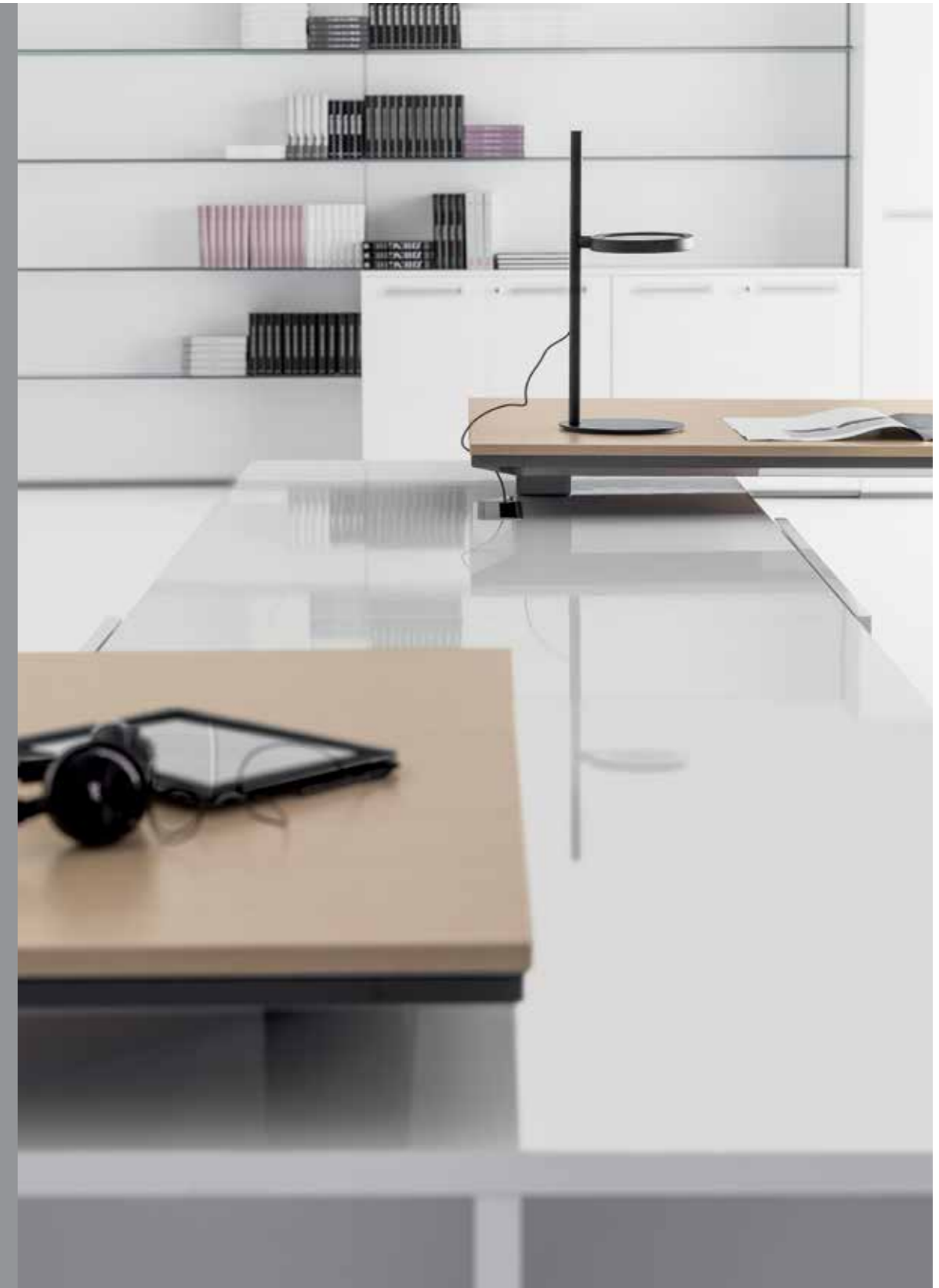





Tavoli/Tables

Piani di lavoro sp. 1.8 cm, in melaminico (*) o laminato (***) con bordi in ABS sp. 0.2 cm / Worktops 1.8 cm thick, in melamine (*) or laminate (***) with ABS edge-profiles 0.2 cm thick

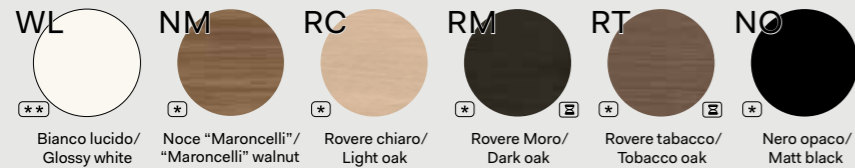

WL Bianco lucido/Glossy white, NM Noce "Maroncelli"/"Maroncelli" walnut, RC Rovere chiaro/Light oak, RM Rovere Moro/Dark oak, RT Rovere tabacco/Tobacco oak, NO Nero opaco/Matt black

Piani di lavoro sp. 1.8 cm, in impiallacciato / Worktop 1.8 cm thick, veneered

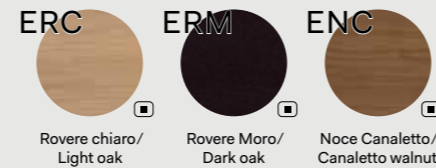

ERC Rovere chiaro/Light oak, ERM Rovere Moro/Dark oak, ENC Noce Canaletto/Canaletto walnut

Piani di lavoro sp. 2 cm, in cuoio con cuciture/Worktop 2 cm thick, in leather with stitches



CBI Cuoio bianco/White hard leather, CNE Cuoio nero/Black hard leather, CTM Cuoio testa di moro/Dark brown hard leather

Piani di lavoro sp. 1 cm, in vetro temprato retrolaccato acidato con bordi perimetrali lavorati a filo lucido/Worktops 1 cm thick, rear-lacquered and acetated tempered glass with outer polished edges

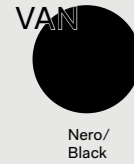

VAN Nero/Black

Piani di lavoro sp. 1 cm, in vetro temprato retrolaccato con bordi perimetrali lavorati a filo lucido / Worktops 1 cm thick, rear-lacquered tempered glass with outer polished edges



VW Bianco/White

Piano di lavoro in vetro temprato trasparente sp. 0.8 cm, accoppiato con piano in gres porcellanato sp. 0.6 cm/Worktop in 0.8 cm thick transparent tempered glass, coupled with a 0.6 cm thick porcelain stoneware worktop

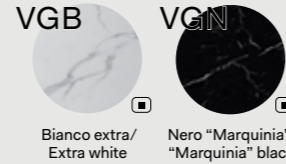

VGB Bianco extra/Extra white, VGN Nero "Marquinia"/"Marquinia" black

Strutture metalliche/Metal structures

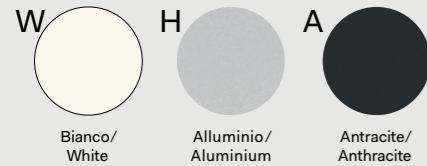

W Bianco/White, H Alluminio/Aluminium, A Antracite/Anthracite

Mobili di servizio/Service units

Scocca, ripiani sp. 2.5 cm e ante sp. 1.8 cm, in melaminico (*) o laminato (***) / Body, shelves 2.5 cm and doors 1.8 cm thick, in melamine (*) or laminate (***)

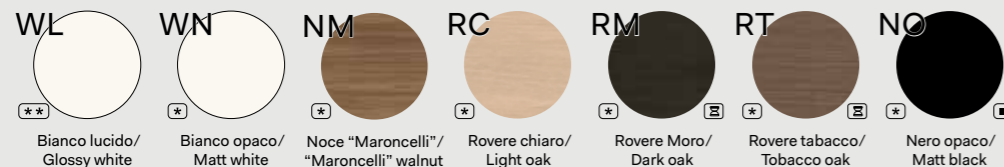

WL Bianco lucido/Glossy white, WN Bianco opaco/Matt white, NM Noce "Maroncelli"/"Maroncelli" walnut, RC Rovere chiaro/Light oak, RM Rovere Moro/Dark oak, RT Rovere tabacco/Tobacco oak, NO Nero opaco/Matt black

Scocca, ripiani sp. 2.5 cm e ante sp. 1.8 cm, in impiallacciato / Body, shelves 2.5 cm and doors 1.8 cm thick, veneered

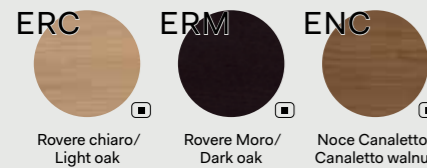

ERC Rovere chiaro/Light oak, ERM Rovere Moro/Dark oak, ENC Noce Canaletto/Canaletto walnut

Note

- Prodotti non in pronta consegna. Per la disponibilità contattare l'ufficio commerciale/Items not in prompt delivery. Please contact the commercial department to check availability.
- Fino ad esaurimento/Until exhaustion.

Tavoli scrivania L 180 con mobile di servizio P 66 (Dx o Sx)/Desks W 180 with service unit D 66 (R or L)

P 180 x H 75	P 180 x H 74	P 180 x H 75	P 180 x H 75	Schema delle 3 posizioni di montaggio / Scheme of 3 assembling solutions L 2 = 212, 180 L 3 = 221,5, 180 Soluzione base/Suggested solution	L 1 = 180 L 3 = 221,5, 180
902.TM.6_18_Sx/L - Dx/R	902.TV.6_18_Sx/L - Dx/R	902.TV.6_18_Sx/L - Dx/R	902.TM.6_18_Sx/L - Dx/R		
902.PM.6_18_Sx/L - Dx/R	902.PV.6_18_Sx/L - Dx/R	902.PV.6_18_Sx/L - Dx/R	902.PM.6_18_Sx/L - Dx/R	Soluzione base/Suggested solution	L 4 = 200 L 6 = 241,5, 200
902.TM.6_20_Sx/L - Dx/R	902.TV.6_20_Sx/L - Dx/R	902.TV.6_20_Sx/L - Dx/R	902.TM.6_20_Sx/L - Dx/R		

Tavoli scrivania L 200 con mobile di servizio P 66 (Dx o Sx)/Desks W 200 with service unit D 66 (R or L)

P 180 x H 75	P 180 x H 74	P 180 x H 75	P 180 x H 75	Schema delle 3 posizioni di montaggio / Scheme of 3 assembling solutions L 5 = 232, 200 L 6 = 241,5, 200 Soluzione base/Suggested solution	L 4 = 200 L 6 = 241,5, 200
902.TM.6_20_Sx/L - Dx/R	902.TV.6_20_Sx/L - Dx/R	902.TV.6_20_Sx/L - Dx/R	902.TM.6_20_Sx/L - Dx/R		
902.PM.6_20_Sx/L - Dx/R	902.PV.6_20_Sx/L - Dx/R	902.PV.6_20_Sx/L - Dx/R	902.PM.6_20_Sx/L - Dx/R	Soluzione base/Suggested solution	L 7 = 206, 180 L 9 = 247,5, 180
902.TM.9_18_Sx/L - Dx/R	902.TV.9_18_Sx/L - Dx/R	902.TV.9_18_Sx/L - Dx/R	902.TM.9_18_Sx/L - Dx/R		

Tavoli scrivania L 180 con mobile di servizio P 92,5 (Dx o Sx)/Desks W 180 with service unit D 92,5 (R or L)

P 180 x H 75	P 180 x H 74	P 180 x H 75	P 180 x H 75	Schema delle 3 posizioni di montaggio / Scheme of 3 assembling solutions L 8 = 225, 180 L 9 = 247,5, 180 Soluzione base/Suggested solution	L 7 = 206, 180 L 9 = 247,5, 180
902.TM.9_18_Sx/L - Dx/R	902.TV.9_18_Sx/L - Dx/R	902.TV.9_18_Sx/L - Dx/R	902.TM.9_18_Sx/L - Dx/R		
902.PM.9_18_Sx/L - Dx/R	902.PV.9_18_Sx/L - Dx/R	902.PV.9_18_Sx/L - Dx/R	902.PM.9_18_Sx/L - Dx/R	Soluzione base/Suggested solution	L 10 = 226, 200 L 12 = 267,5, 200
902.TM.9_20_Sx/L - Dx/R	902.TV.9_20_Sx/L - Dx/R	902.TV.9_20_Sx/L - Dx/R	902.TM.9_20_Sx/L - Dx/R		

Tavoli scrivania L 200 con mobile di servizio P 92,5 (Dx o Sx)/Desks W 200 with service unit D 92,5 (R or L)

P 180 x H 75	P 180 x H 74	P 180 x H 75	P 180 x H 75	Schema delle 3 posizioni di montaggio / Scheme of 3 assembling solutions L 11 = 245, 200 L 12 = 267,5, 200 Soluzione base/Suggested solution	L 10 = 226, 200 L 12 = 267,5, 200
902.TM.9_20_Sx/L - Dx/R	902.TV.9_20_Sx/L - Dx/R	902.TV.9_20_Sx/L - Dx/R	902.TM.9_20_Sx/L - Dx/R		
902.PM.9_20_Sx/L - Dx/R	902.PV.9_20_Sx/L - Dx/R	902.PV.9_20_Sx/L - Dx/R	902.PM.9_20_Sx/L - Dx/R	Soluzione base/Suggested solution	L 11 = 245, 200 L 12 = 267,5, 200
902.TM.9_20_Sx/L - Dx/R	902.TV.9_20_Sx/L - Dx/R	902.TV.9_20_Sx/L - Dx/R	902.TM.9_20_Sx/L - Dx/R		

Note:

- Le finiture impiallacciato, gres e cuoio non sono in pronta consegna. Per la disponibilità contattare l'ufficio commerciale/Veneered, porcelain stoneware and leather finishes are not in prompt delivery. Please contact the commercial department to check availability;
- I tavoli possono essere montati sui mobili di servizio (destris o sinistri) scegliendo tra 3 diverse posizioni. Per ogni soluzione compositiva è disponibile la dimensione del corrispondente modesty panel (vedi relativa quota indicata con MP) mentre il canale passacavi si ordina secondo la lunghezza del piano di lavoro utilizzato/ The desks can be mounted on service units (right or left hand) in 3 different positions. Find the proper modesty panel to match the chosen composition (see sizes indicated with MP), while the cable channels change according to the size of the worktop;
- Le dimensioni sono espresse in cm - consultare il listino prezzi per le caratteristiche tecniche, i codici degli articoli e delle finiture/Dimensions are stated in cm - for technical characteristics, article code numbers and finishing see price list;
- Prodotti non in pronta consegna. Per la disponibilità contattare l'ufficio commerciale/Items not in prompt delivery. Please contact the commercial department to check availability;
- Articolo subordinato a commessa minima. Previsto anche nella versione con fori e tappi passacavi (Optional - Vedere listino)/Item tied-up to a minimum quantity production. Also foreseen in a version including holes and out-let lids. (Optional - Refer to price list);
- Vetro/Glass; C Cuoio/Leather; G Gres/Gres.

Tavoli per composizioni/Desks for compositions

P 90 x H 75 V	P 90 x H 74 V	P 90 x H 75 G	P 90 x H 75 C	P 90 x H 75	P 90 x H 74 V	P 90 x H 74 G
902.TI.15.18_L 180 902.TI.15.20_L 200	902.TV.11.18_L 180 902.TV.11.20_L 200	902.TV.11.18_L 180 902.TV.11.20_L 200	902.TI.15.18_L 180 902.TI.15.20_L 200	902.TI.1.18_L 180 902.TI.1.20_L 200	902.TV.1.18_L 180 902.TV.1.20_L 200	902.TV.1.18_L 180 902.TV.1.20_L 200
P 90 x H 75 C	P 90 x H 75	P 90 x H 74 V	P 90 x H 74 G	P 90 x H 75 C		
902.TI.1.18_L 180 902.TI.1.20_L 200	902.TI.2.18_L 180 902.TI.2.20_L 200	902.TV.2.18_L 180 902.TV.2.20_L 200	902.TV.2.18_L 180 902.TV.2.20_L 200	902.TI.2.18_L 180 902.TI.2.20_L 200		

Tavoli riunione/Meeting tables

Ø 100 x H 74,5 V	Ø 100 x H 75 G	L 100 P 100 x H 75	L 100 P 100 x H 74,5 V	L 100 P 100 x H 75 G	L 100 P 100 x H 75 C	L 160 P 160 x H 75	L 160 P 160 x H 74,5 V	L 160 P 160 x H 75 C
902.TV.15.10_	902.TV.15.10_	902.TR.42.10_	902.TV.77.10_	902.TV.77.10_	902.TR.42.10_	902.TR.43.16_	902.TV.38.16_	902.TR.43.16_
L 140 P 140 x H 75,5 G	L 160 P 160 x H 75 L	L 160 P 160 x H 75 C	L 240 P 120 x H 75 V	L 240 P 120 x H 74,5 G	L 240 P 120 x H 74,5 C	L 240 P 120 x H 75 G	L 240 P 120 x H 75 C	
902.TV.38.14_	902.TR.51.16_	902.TR.51.16_	902.TR.41.24_	902.TV.36.24_	902.TV.36.24_	902.TV.36.24_	902.TR.41.24_	

Tavoli riunione componibili con gambe centrali rientrate/Modular meeting tables with central recessed legs

L 320 P 160 x H 75	L 320 P 160 x H 74,5 V	L 320 P 160 x H 75 C	L 320 P 160 x H 75 L	L 320 P 160 x H 75 C	L 480 P 160 x H 75
902.TR.32.32_	902.TV.47.32_	902.TR.32.32_	902.TR.53.32_	902.TR.53.32_	902.TR.32.48_
L 480 P 160 x H 74,5 V	L 480 P 160 x H 75 C	L 480 P 160 x H 75 L	L 480 P 160 x H 75 C	L 480 P 160 x H 75 L	
902.TV.47.48_	902.TR.32.48_	902.TR.53.48_	902.TR.53.48_	902.TR.53.48_	

Elementi per tavoli riunioni componibili con gambe centrali rientrate/Modular elements for compound meeting tables with central recessed legs

L 160 P 160 x H 75	L 160 P 160 x H 74,5 V	L 160 P 160 x H 75 C	L 160 P 160 x H 75 L	L 160 P 160 x H 75 C
902.TR.32.16_	902.TV.47.16_	902.TR.32.16_	902.TR.53.16_	902.TR.53.16_

Modesty panel – canalizzazione per tavoli scrivanie su mobili di servizio/Modesty panel – wire management for desks on service units

Per tavoli L 180/For desks W 180				Per tavoli L 200/For desks W 200		
902.AP.15.16_L 140 (L 180)	902.MP.08.10_L 100 (L 1-L 7) 902.MP.08.12_L 120 (L 8) 902.MP.08.13_L 130 (L 2) 902.MP.08.14_L 140 (L 3-L 9)	902.MP.13.12_L 120 (L 8) 902.MP.13.13_L 130 (L 2) 902.MP.13.14_L 140 (L 3-L 9)	902.MP.13.13_L 130 (L 2) 902.MP.13.14_L 140 (L 3-L 9)	902.MP.09.12_L 120 (L 4-L 10) 902.MP.09.14_L 140 (L 11) 902.MP.09.15_L 150 (L 5) 902.MP.09.16_L 160 (L 6-L 12)	902.MP.14.12_L 120 (L 4-L 10) 902.MP.14.14_L 140 (L 11) 902.MP.14.15_L 150 (L 5) 902.MP.14.16_L 160 (L 6-L 12)	

Modesty panel in cuoio /Leather modesty panel

P 1,8 x H 38 C	Per tavoli L 180/For desks W 180 C	Per tavoli L 200/For desks W 200 C	Per tavoli L 200/For desks W 200 C	Accessori /Accessories L 90 P 60 x H 2 C
902.MP.08.10_L 100 (L 1-L 7) 902.MP.08.12_L 120 (L 8) 902.MP.08.13_L 130 (L 2)	902.MP.08.14_L 140 (L 3-L 9)	902.MP.09.12_L 120 (L 4-L 10)	902.MP.09.14_L 140 (L 11) 902.MP.09.15_L 150 (L 5) 902.MP.09.16_L 160 (L 6-L 12)	300.AS.01.09

Canalizzazione per tavoli scrivanie/Wire management for desks

902.AP.17.16_ Per./For: L 160	902.AP.18.16_ Per./For: L 160	902.AP.24.12_ Per./For: L 240	902.AP.32.12_ Per./For: L 320

Cassettiere/Pedestals

L 42 P 57 x H 55,5 V	L 32,2 P 54,2 x H 55,6 V	L 42,2 P 54,2 x H 55,6 V	L 180 P 66 x H 63 Dx/R	L 180 P 92,5 x H 63 Dx/R	L 42 P 55 x H 48 V
550.CS.10.04 Melaminico/Melamine	550.CS.20.04 Melaminico/Melamine	550.CS.1M.03 Metalliche/Metallic	902.MS.6.18 Sx/L - Dx/R Indipendenti e per integrazione /Independent and for integration	902.MS.9.18 Sx/L - Dx/R Indipendenti e per integrazione /Independent and for integration	550.CM.01.04

Note: La finitura impiallacciato non è in pronta consegna. Per la disponibilità contattare l'ufficio commerciale. Per portacancelleria cassetti, vedi capitolo DV300-Accessori/Veneered finishes is not in prompt delivery. Please contact the commercial department to check availability. For stationary tray, see chapter DV300-Accessories.

Accessori per canalizzazione – Elettrificazione – Vari/Accessories for wire management – Electrification – Various

300.AC.26.02 L 24,5 300.AC.26.03 L 34,5 300.AC.26.04 L 44,5	300.AC.38.02_H 2,4	300.AC.67.03 Mansupio per top access 300.AC.36... 300.AC.38... / Basket for top access 300.AC.36... 300.AC.38...	300.APS.1.02 L 20,5 300.APS.1.03 L 30 300.APS.1.04 L 42 Per/For top access 300.AC.26...	300.AT.A6.02 L 21 300.AT.A6.03 L 25,5 300.AT.A6.04 L 39	300.APT.4.01 300.APT.5.01 - UK 300.APT.6.01 - US	300.AP.T.8.11 300.AP.T.8.14 300.AP.T.8.17 300.AP.T.8.20
300.APT.2.01 Ø 8	300.AC.06.05_	300.APV.2.15	300.APV.1.00	300.AC.04.01 Braccio porta video mobile su piano /Dynamic arm for video support on deskbase	300.AC.04.02 Doppio braccio porta video mobile su piano /2 dynamic arms for video support on deskbase	300.AC.03.01 Braccio porta video statico su palo /Dynamic arm for video support on deskbase
300.AC.03.02 Doppio braccio porta video statico su palo /2 Static arms for video support on pole	300.AC.02.01 Braccio porta video mobile su piano /Dynamic arm for video support on deskbase	300.AC.02.02 Doppio braccio porta video mobile su piano /2 dynamic arms for video support on deskbase	300.AC.01.01 Braccio porta video statico su palo /Static arm for video support on pole	300.AC.01.02 Doppio braccio porta video statico su palo /2 Static arms for video support on pole		

Note:

- Le finiture impiallacciato e gres non sono in pronta consegna. Per la disponibilità contattare l'ufficio commerciale /Veneered and gres finishes are not in prompt delivery. Please contact the commercial department to check availability;
 - Per la scelta dei contenitori e degli accessori vari, consultare il relativo listino o catalogo/To choose storage units and accessories, please check correspondent price list or catalogue;
 - Le dimensioni sono espresse in cm – consultare il listino prezzi per le caratteristiche tecniche, i codici degli articoli e delle finiture/Dimensions are stated in cm – for technical characteristics, article code numbers and finishing see price list;
- Prodotti non in pronta consegna. Per la disponibilità contattare l'ufficio commerciale/Items not in prompt delivery. Please contact the commercial department to check availability;
- Articoli prodotti solo su richiesta/Items produced only on demand;
- Fino ad esaurimento/Until exhaustion;
- Per eventuali giacenze a magazzino delle precedenti versioni senza top-access, contattare l'ufficio commerciale/To check stock availabilities of table tops without top-access, please contact our commercial department;
- Vetro/Glass; Cuoio/Leather; Gres/Gres;
- Con serratura/With lock;
- Tavoli scrivania con piani composti /Desks with compound worktops.

DV910 Oxford

Design:
Antonio Morello

Comp. N°1

IT Collezione direzionale che comprende un'ampia gamma di elementi di arredo; elementari geometrie, basate su linee e forme essenziali, che si intersecano fra loro e creano un insieme dotato di grande eleganza. L'effetto minimale viene stemperato dalle combinazioni fra le finiture, in particolare dagli inserti effetto pelle che ne sottolineano ulteriormente il carattere geometrico. La serie si arricchisce di tavoli scrivania regolabili in altezza elettricamente.

EN Executive collection that includes a wide range of furniture items; elementary geometries, based on essential lines and shapes, which intersect each other and create a whole with great elegance. The minimal effect is softened by the combinations of finishes, in particular by the leather-effect inserts that further emphasize the geometric character. The series is enriched with electrically height-adjustable desk tables.

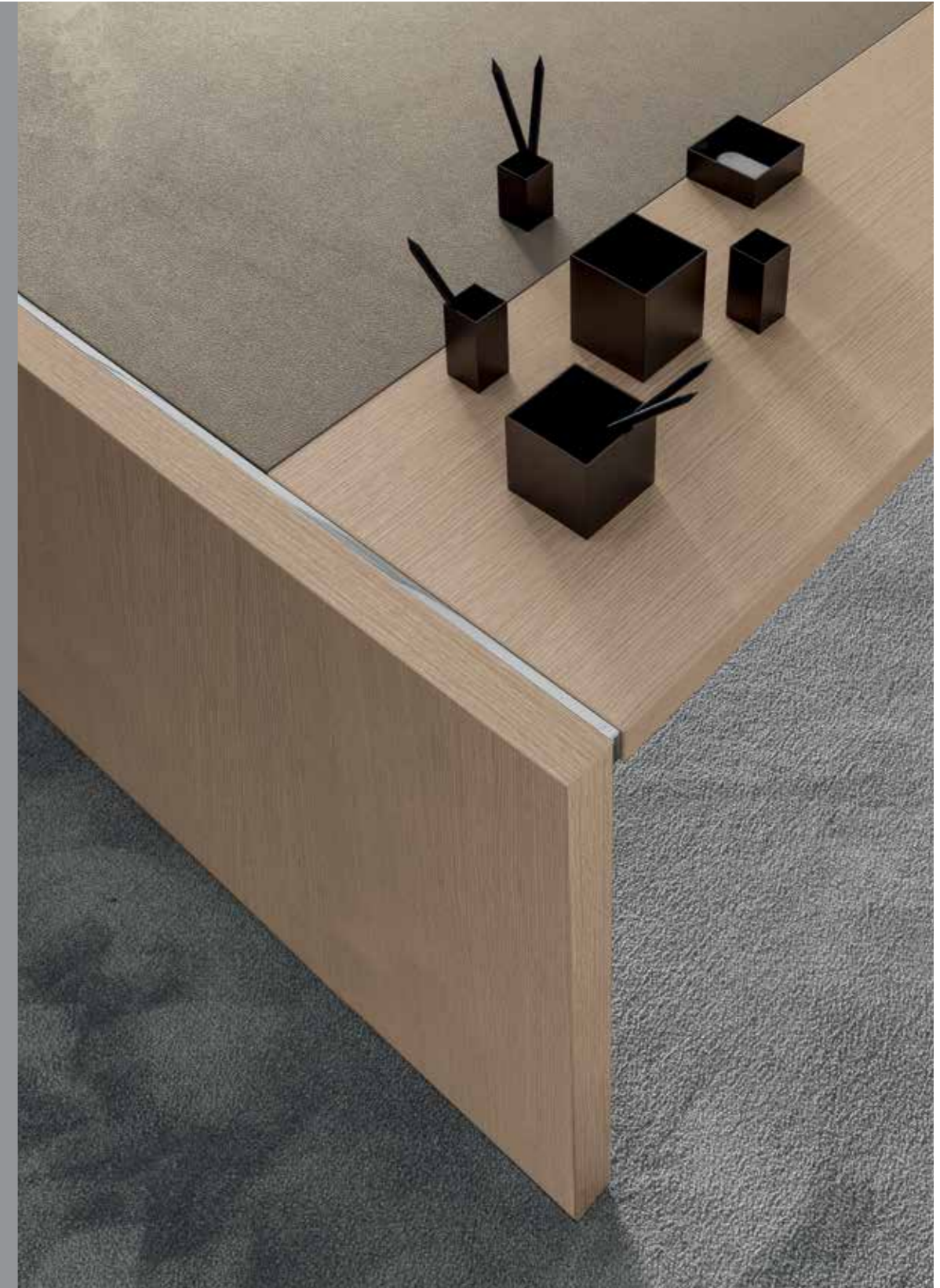





DV910 Oxford

Design:
Antonio Morello

Comp. N°2A









DV910 Oxford

Design:
Antonio Morello

Comp. N°2B

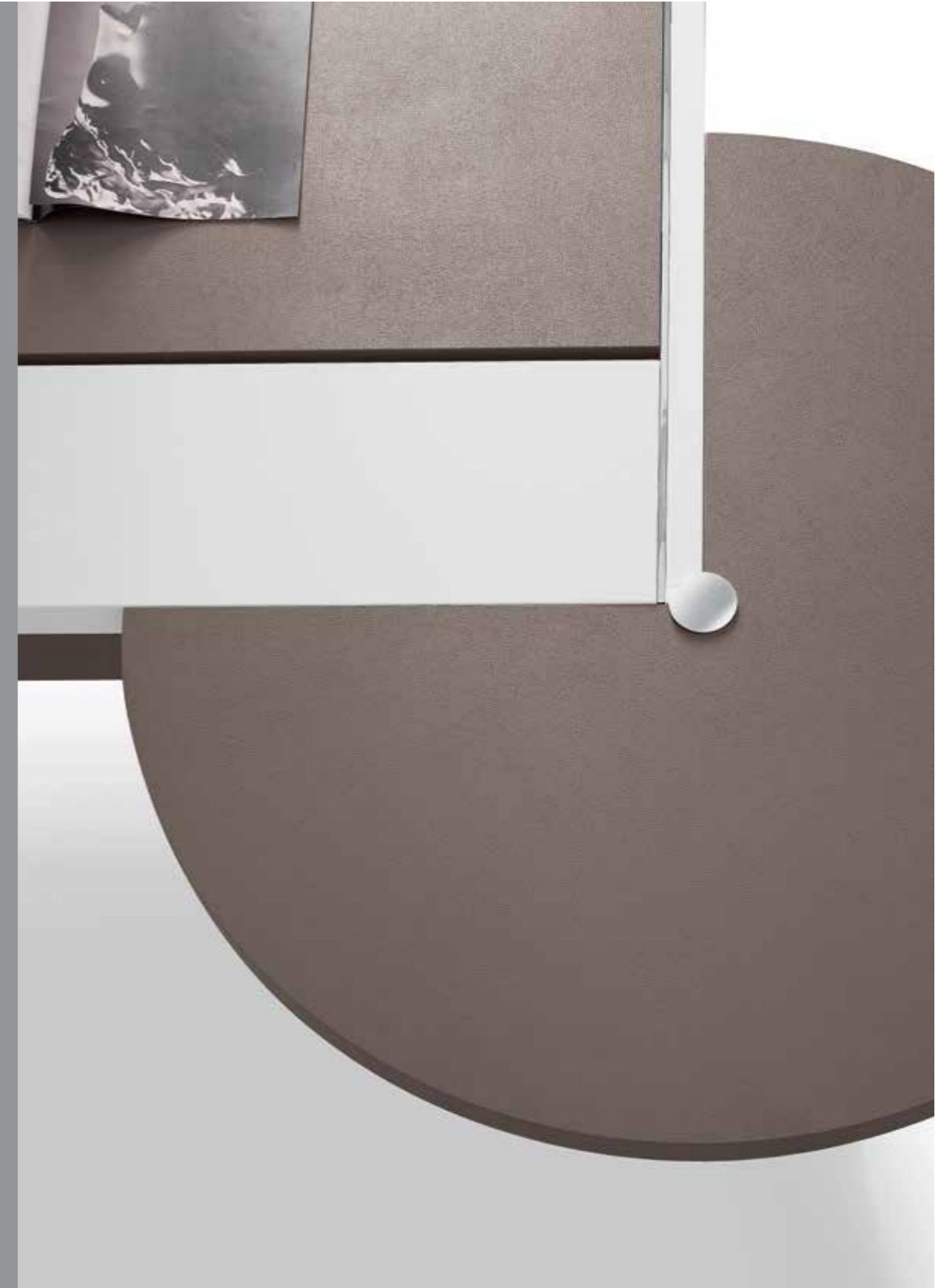



DV910 Oxford

Design:
Antonio Morello

Comp. N°3

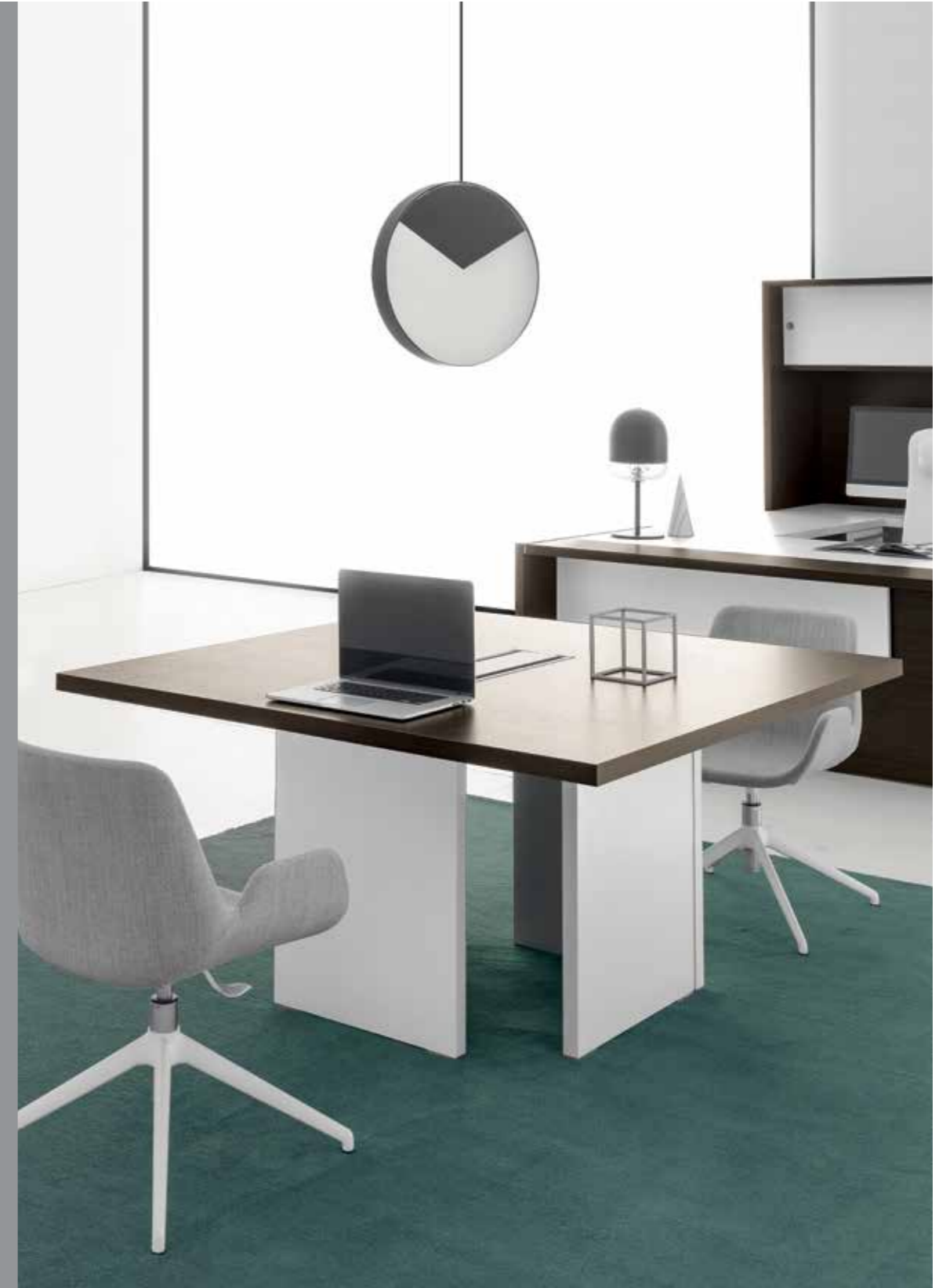





DV910 Oxford

Design:
Antonio Morello

Comp. N°4





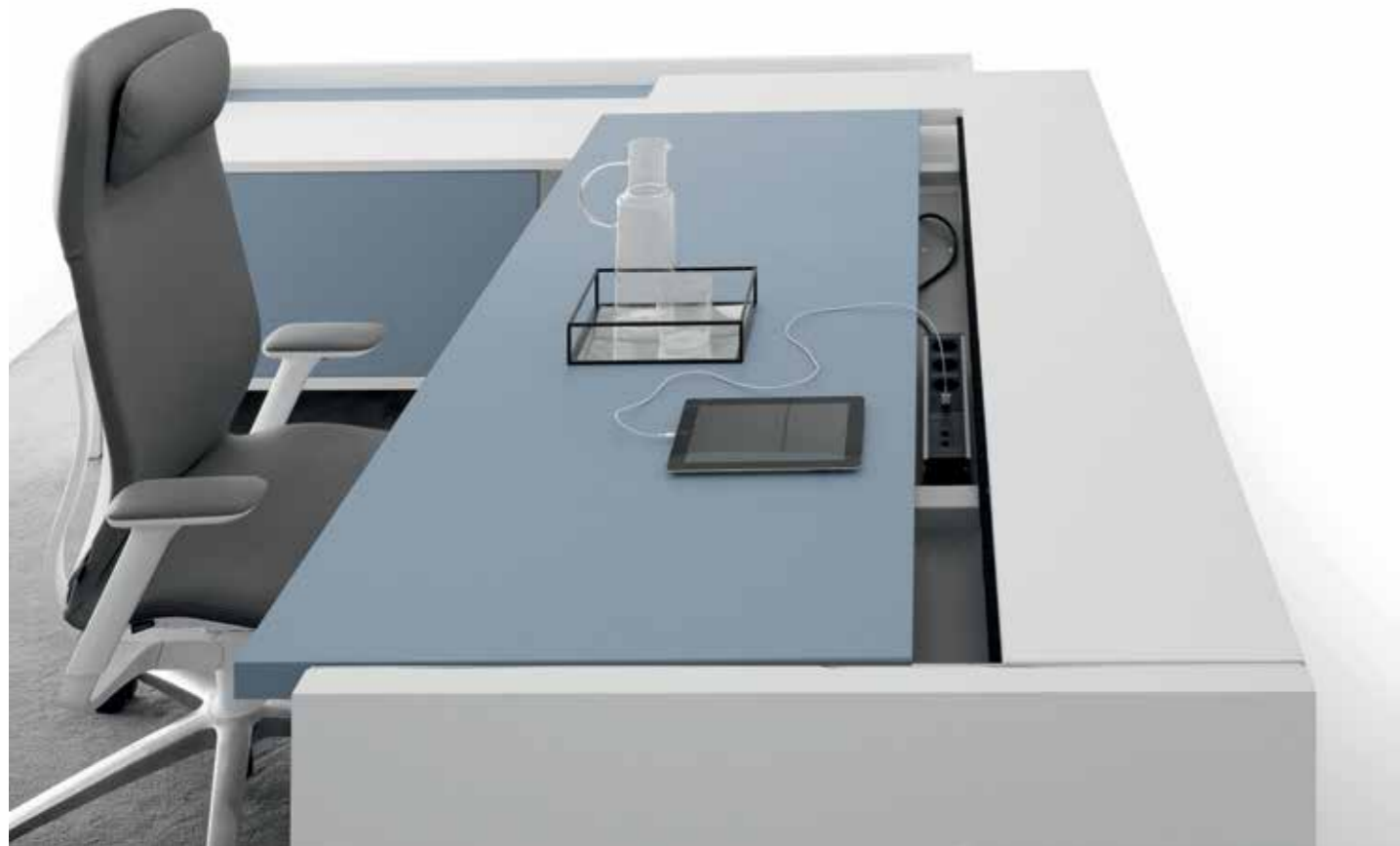



DV910 Oxford

Design:
Antonio Morello

Comp. N°5







DV910 Oxford

Design:
Antonio Morello

Comp. N°6









Tavoli/Tables

Piani di lavoro sp. 3.8 cm, in melaminico con bordi in ABS sp. 0.2 cm /
Worktops 3.8 cm thick, in melamine with ABS edge-profiles 0.2 cm thick



Piano di lavoro effetto pelle sp. 3.8 cm /
Leather effect worktop 3.8 cm thick



Piano frontale dei piani composti - Gambe pannellate e struttura in melaminico sp. 3.8 cm /
Frontal melamine worktops (for compound worktops) - Melamine panelled legs and frame 3.8 cm thick



Modesty panel in melaminico sp. 2.5 cm / Melamine modesty panel 2.5 cm thick



Modesty panel effetto pelle sp. 2.5 cm / Leather effect modesty panel 2.5 cm thick



Contenitori multifunzione e Mobili di servizio/Multi - purpose storage unit and Service units

Scocche in melaminico/Melamine shells



Ante mobile di servizio, contenitore multifunzione e frontali cassettera sp. 1.8 cm - Sportello apribile mobile di servizio sp. 2.5 cm /
Service unit, multi-purpose unit doors and drawers front panel 1.8 cm thick - Service unit flip door 2.5 cm thick



Schiena pinnabile in tessuto 100% poliestere Trevira CS/Pinnable back panel with 100% polyester Trevira CS fabric

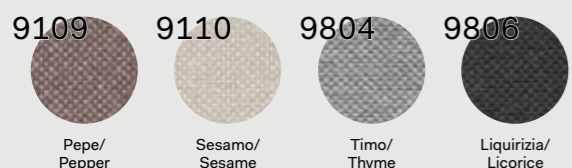

Note

Prodotti non in pronta consegna. Per la disponibilità contattare l'ufficio commerciale/Items not in prompt delivery. Please contact the commercial department to check availability;
Fino ad esaurimento/Until exhaustion.

Tavoli scrivania H 75/Desks tables H 75

P 90 x H 75
CM

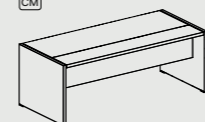

910.TS.68.20_L 204
910.TS.68.22_L 224

P 90 x H 75
CM

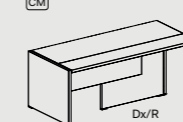

910.TS.59.20_L 200 Dx/R - Sx/L
910.TS.59.22_L 220 Dx/R - Sx/L

Tavoli scrivania H 75 su allungo H 71/
Tables H 75 on lateral extension H 71

P 210 x H 75
CM

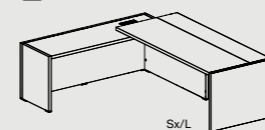

910.TM.42.23_L 230 Dx/R - Sx/L
910.TM.42.25_L 250 Dx/R - Sx/L

Tavoli scrivania con allungo H 75/
Tables with lateral extension H 75

P 210 x H 75
CM

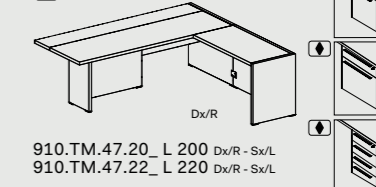

910.TM.47.20_L 200 Dx/R - Sx/L
910.TM.47.22_L 220 Dx/R - Sx/L

Tavoli scrivania H 75 con mobile di servizio H 65 con anta scorrevole/
Tables H 75 with service unit H 65 with sliding door

P 210 x H 75
CM

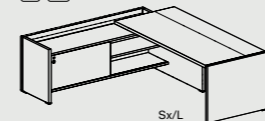

910.TM.32.23_L 230 Dx/R - Sx/L
910.TM.32.25_L 250 Dx/R - Sx/L

P 210 x H 75
CM

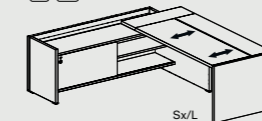

910.TM.33.23_L 230 Dx/R - Sx/L
910.TM.33.25_L 250 Dx/R - Sx/L

Tavolini caffè/Coffee tables

P 60 x H 45

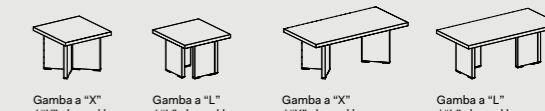

Gamba a "X" / "X" shaped leg
910.TT.03.06_L 60
Gamba a "L" / "L" shaped leg
910.TT.03.12_L 120

Tavoli riunione/Meeting tables

L 140 P 140 x H 75

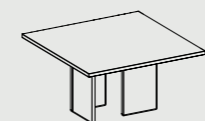

910.TR.38.14_

L 240 P 120 x H 75

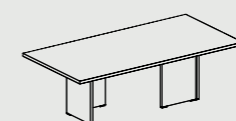

910.TR.41.24_

Raccordo/Connection element

Ø 120 x H 75

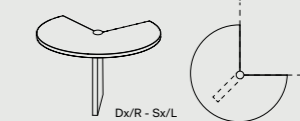

910.PE.01.12_

Tavoli scrivania regolabili in altezza a tre stadi elettricamente da H 77÷142 cm
/Desks adjustable in H electrical at three stages from H 77 to H 142 cm

P 90 x H 77 ÷ 142
CM

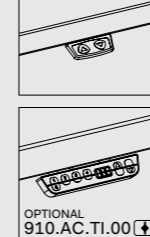

P 214 x H 77 ÷ 142
CM

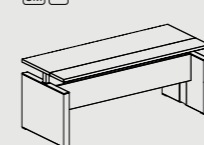

910.TS.69.20_L 200
910.TS.69.22_L 220

P 214 x H 77 ÷ 142
CM

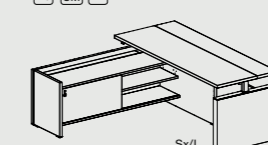

910.TM.34.20_L 200 Dx/R - Sx/L
910.TM.34.22_L 220 Dx/R - Sx/L

P 214 x H 77 ÷ 142
CM

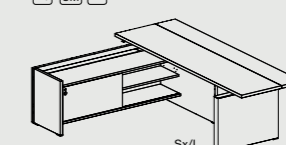

910.TM.34.27_L 270 Dx/R - Sx/L

Catena passacavi
/Cable management chain

L 120 P 5 x H 3



910.AP.10.00

Note:

Le dimensioni sono espresse in cm - consultare il listino prezzi per le caratteristiche tecniche, i codici degli articoli e delle finiture/Dimensions are stated in cm - for technical characteristics, article code numbers and finishing see price list;
Con serratura/With lock.

Sotto i piani in allungo delle composizioni con il mobile multifunzione è possibile integrare le cassette 910.EC.03... e 910.EC.04.04 /It is possible to integrate 910.EC.03... and 910.EC.04.04 pedestals under the extension worktops of the compositions with multi-purpose storage unit.

Prodotti non in pronta consegna. Per la disponibilità contattare l'ufficio commerciale/Items not in prompt delivery. Please contact the commercial department to check availability;

Piano composto/Compound worktop.
Piano composto sliding/Sliding compound worktop.
Tastierino per regolazione altezza piano con memorie / Control pad with memories for height adjustable worktop.

DV910 Oxford

Contenitore multifunzione / Multi-purpose storage unit

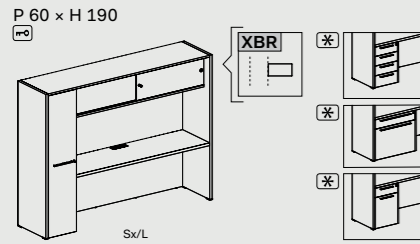

910.HC.01.25_ L 250 Dx/R - Sx/L

Accessori contenitore multifunzione / Accessories multi-purpose storage unit

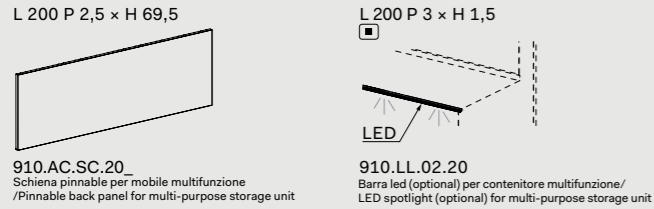

910.AC.SC.20_ Schiena pinnabile per mobile multifunzione / Pinnable back panel for multi-purpose storage unit

910.LL.02.20 Barra led (optional) per contenitore multifunzione / LED spotlight (optional) for multi-purpose storage unit

Cassettiere per contenitori / Pedestals for wardrobe

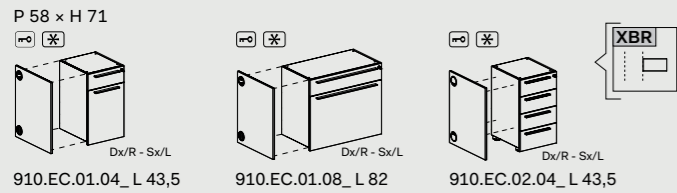

910.EC.01.04_ L 43,5

910.EC.01.08_ L 82

910.EC.02.04_ L 43,5

Cassetti metallici / Metallic drawer

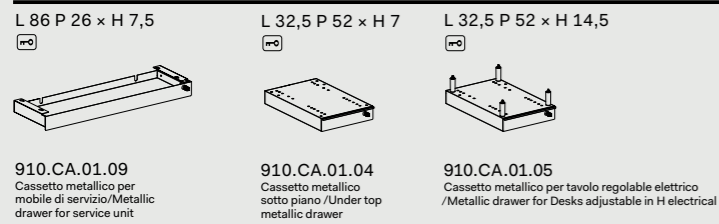

910.CA.01.09 Cassetto metallico per mobile di servizio / Metallic drawer for service unit

910.CA.01.04 Cassetto metallico sotto piano / Under top metallic drawer

910.CA.01.05 Cassetto metallico per tavolo regolabile elettrico / Metallic drawer for Desks adjustable in H electrical

Cassettiere su ruote / Pedestals on castors

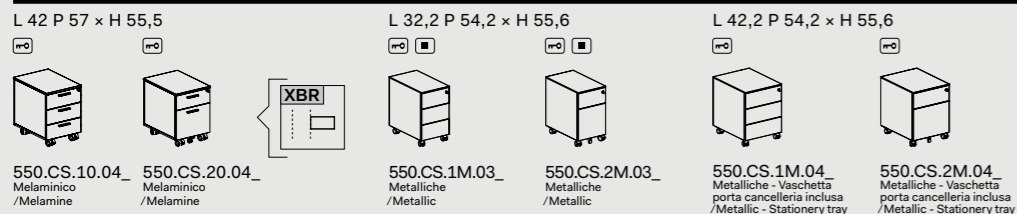

550.CS.10.04_ Melaminico / Melamine

550.CS.20.04_ Melaminico / Melamine

550.CS.1M.03_ Metalliche / Metallic

550.CS.2M.03_ Metalliche / Metallic

550.CS.1M.04_ Metalliche - Vaschetta porta cancelleria inclusa / Metallic - Stationery tray included

550.CS.2M.04_ Metalliche - Vaschetta porta cancelleria inclusa / Metallic - Stationery tray included

Note: La finitura impiallacciato non è in pronta consegna. Per la disponibilità contattare l'ufficio commerciale. Per portacancelleria cassetti, vedi capitolo DV300-Accessori / Veneered finishes is not in prompt delivery. Please contact the commercial department to check availability. For stationary tray, see chapter DV300-Accessories.

Note:

② Le dimensioni sono espresse in cm - consultare il listino prezzi per le caratteristiche tecniche, i codici degli articoli e delle finiture / Dimensions are stated in cm - for technical characteristics, article code numbers and finishing see price list;

■ Prodotti non in pronta consegna. Per la disponibilità contattare l'ufficio commerciale / Items not in prompt delivery. Please contact the commercial department to check availability;

☑ Con serratura / With lock.

☒ Sotto i piani dei contenitori multifunzione è possibile integrare le cassettiere 910.EC.01._ e 910.EC.02.04 / It is possible to integrate 910.EC.01._ and 910.EC.02.04 pedestals under the worktops of the multi-purpose storage unit.

☑ Sotto i piani in allungo delle composizioni con il mobile multifunzione è possibile integrare le cassettiere 910.EC.03._ e 910.EC.04.04 / It is possible to integrate 910.EC.03._ and 910.EC.04.04 pedestals under the extension worktops of the compositions with multi-purpose storage unit.

Dati tecnici / Technical data

Composizioni con piano composto / Compositions with compound worktop

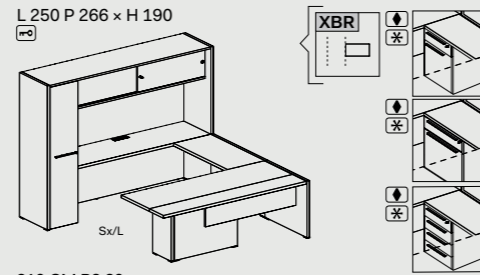

910.CM.P2.20_ Dx/R - Sx/L

910.CM.P2.22_ Dx/R - Sx/L

Cassettiere per allunghi / Pedestals for extension tables

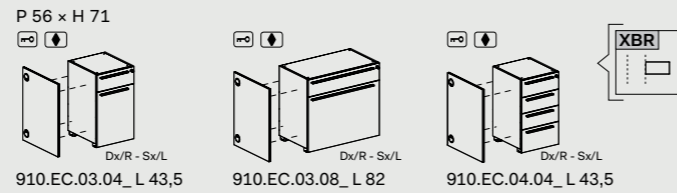

910.EC.03.04_ L 43,5

910.EC.03.08_ L 82

910.EC.04.04_ L 43,5

Accessori mobile di servizio / Accessories service unit

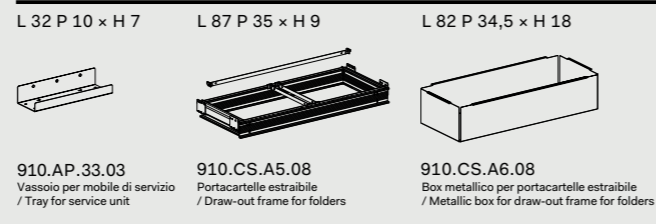

910.AP.33.03 Vassoio per mobile di servizio / Tray for service unit

910.CS.A5.08 Portacartelle estraibile / Draw-out frame for folders

910.CS.A6.08 Box metallico per portacartelle estraibile / Metallic box for draw-out frame for folders

DV910 Oxford

Dati tecnici / Technical data

Accessori per canalizzazione - Elettrificazione - Vari / Accessories for wire management - Electrification - Various

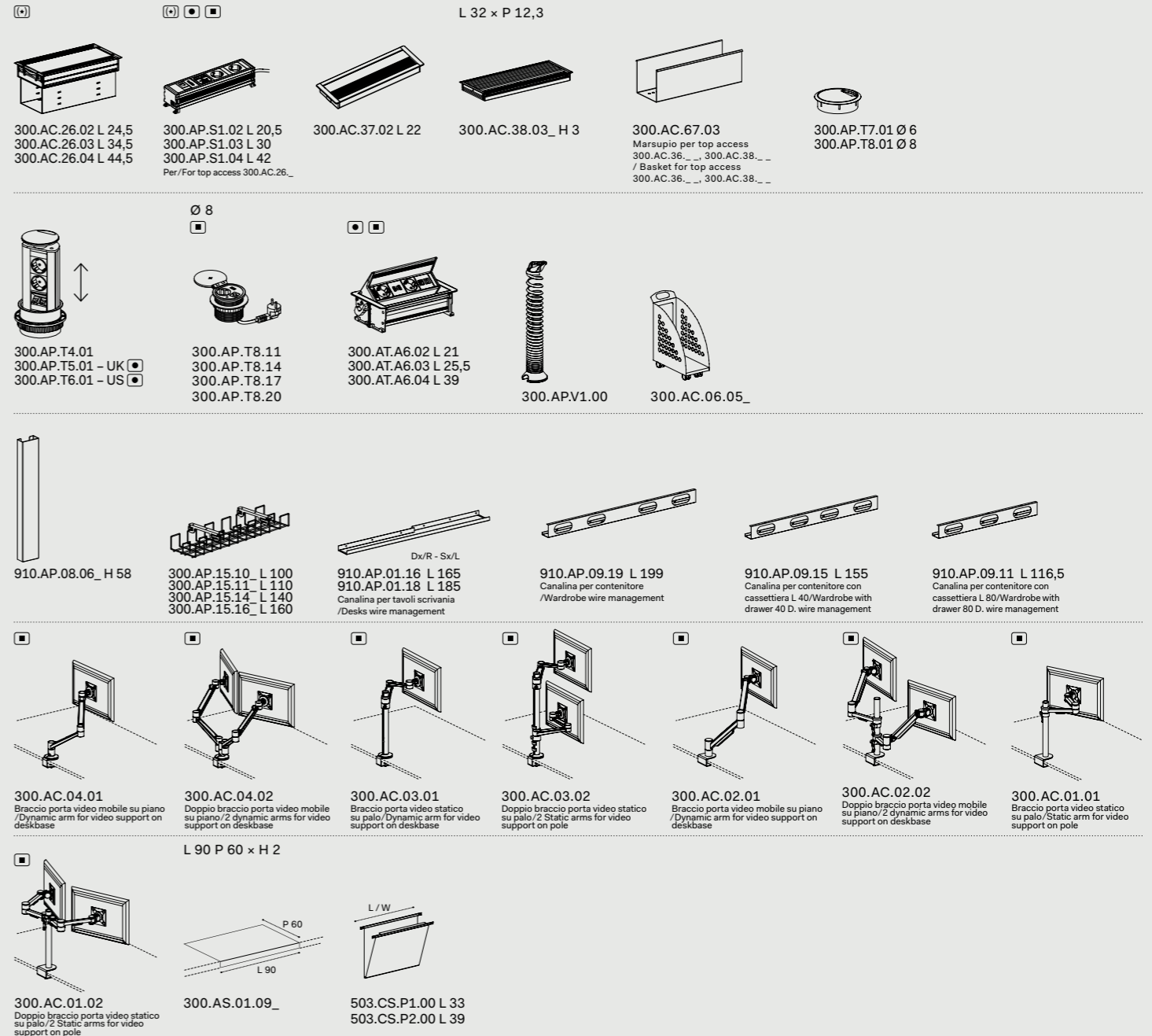

300.AC.26.02 L 24,5
300.AC.26.03 L 34,5
300.AC.26.04 L 44,5

300.AP.S1.02 L 20,5
300.AP.S1.03 L 30
300.AP.S1.04 L 42
Per/For top access 300.AC.26_

300.AC.37.02 L 22

300.AC.38.03_ H 3

300.AC.67.03 Marsupio per top access 300.AC.36_... 300.AC.38_... / Basket for top access 300.AC.36_... 300.AC.38_...

300.AP.T7.01 Ø 6
300.AP.T8.01 Ø 8

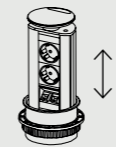

300.AP.T4.01
300.AP.T5.01 - UK
300.AP.T6.01 - US



300.AP.T8.11
300.AP.T8.14
300.AP.T8.17
300.AP.T8.20



300.AT.A6.02 L 21
300.AT.A6.03 L 25,5
300.AT.A6.04 L 39



300.AP.V1.00

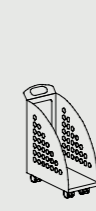

300.AC.06.05_



910.AP.08.06_ H 58

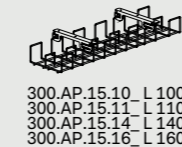

300.AP.15.10_ L 100
300.AP.15.11_ L 110
300.AP.15.14_ L 140
300.AP.15.16_ L 160

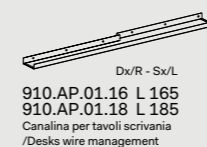

910.AP.01.16 L 165
910.AP.01.18 L 185
Canalina per tavoli scrivania / Desks wire management

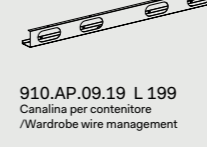

910.AP.09.19 L 199
Canalina per contenitore / Wardrobe wire management

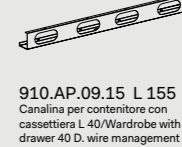

910.AP.09.15 L 155
Canalina per contenitore con cassetiera L 40 / Wardrobe with drawer 40 D. wire management

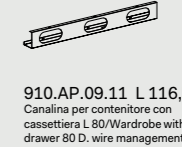

910.AP.09.11 L 116,5
Canalina per contenitore con cassetiera L 80 / Wardrobe with drawer 80 D. wire management

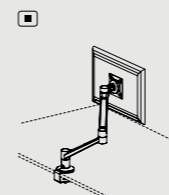

300.AC.04.01 Braccio porta video mobile su piano / Dynamic arm for video support on deskbase

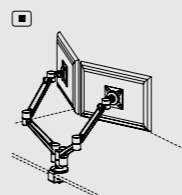

300.AC.04.02 Doppio braccio porta video mobile su piano / 2 dynamic arms for video support on deskbase

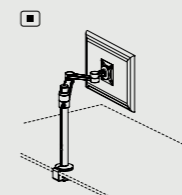

300.AC.03.01 Braccio porta video statico su palo / Dynamic arm for video support on deskbase

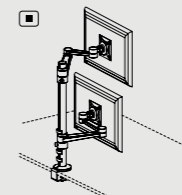

300.AC.03.02 Doppio braccio porta video statico su palo / 2 Static arms for video support on pole

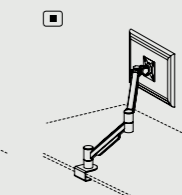

300.AC.02.01 Braccio porta video mobile su piano / Dynamic arm for video support on deskbase

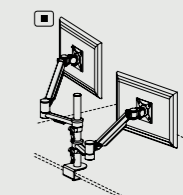

300.AC.02.02 Doppio braccio porta video mobile su piano / 2 dynamic arms for video support on deskbase

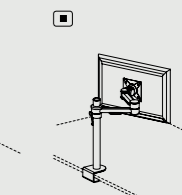

300.AC.01.01 Braccio porta video statico su palo / Static arm for video support on pole

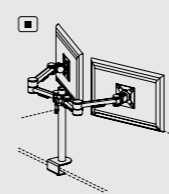

300.AC.01.02 Doppio braccio porta video statico su palo / 2 Static arms for video support on pole

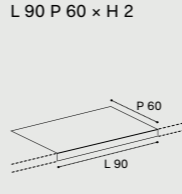

300.AS.01.09_

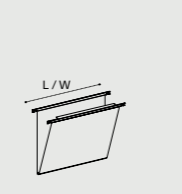

503.CS.P1.00 L 33
503.CS.P2.00 L 39

Note:

① Per la scelta dei contenitori e degli accessori vari, consultare il relativo listino o catalogo / To choose storage units and accessories, please check correspondent price list or catalogue;

■ Prodotti non in pronta consegna. Per la disponibilità contattare l'ufficio commerciale / Items not in prompt delivery. Please contact the commercial department to check availability;

☒ Fino ad esaurimento / Until exhaustion;

② Le dimensioni sono espresse in cm - consultare il listino prezzi per le caratteristiche tecniche, i codici degli articoli e delle finiture / Dimensions are stated in cm - for technical characteristics, article code numbers and finishing see price list;

■ Articoli prodotti solo su richiesta / Items produced only on demand;

DVO S.R.L. con unico socio
Via XX Settembre, 272
Casella Postale n. 65
U.P. Roveredo in Piano
33080 Roveredo in Piano (PN)
Italy

Tel. +39 0434 386 111
Fax +39 0434 386 112
www.dvo.it
info@dvo.it

Art Director
Enzo Berti

Photo
Tobia Berti

Stylist
Mara Zambon

Issue 01
May 2021

Foto e testi copyright
DVO non riproducibili.
La venditrice si riserva
la facoltà di apportare
al prodotto eventuali
modifiche tecniche,
dimensionali ed estetiche
in qualsiasi momento
senza preavviso.

Pictures and text are
DVO copyright, duplicate
forbidden. The selling
Company reserves the
right to introduce changes
to products regarding
sizes and aesthetical
or technical aspects at
any time without notice.



DVO S.R.L. - AZIENDA CERTIFICATA / CERTIFIED COMPANY



Richiedi i prodotti certificati FSC® / Request for FSC® certified products

Il marchio della
gestione forestale
responsabile

dvo_

DVO S.R.L. con unico socio
Via XX Settembre, 272
Casella Postale n. 65
U.P. Roveredo in Piano
33080 Roveredo in Piano (PN)
Italy

Tel. +39 0434 386 111
Fax +39 0434 386 112
www.dvo.it
info@dvo.it